

2009

Wheel bearing kits, seals and tools for commercial vehicles

Radlagersätze, Dichtungen und Werkzeuge für Nutzfahrzeuge

Kits de roulements de roue, joint et outillage pour véhicules industriels

Kits cuscinetti ruota, tenute ed attrezzature veicoli commerciali

Kits de rodamientos de rueda, retenes y herramientas para vehículos industriales





Maintaining a 350 km/h R&D lab



Official
Supplier



Scuderia
Ferrari

In addition to SKF's renowned research and development facilities in Europe and the United States, Formula One car racing provides a unique environment for SKF to push the limits of the complex and fully diversified bearing related technology. A Ferrari single-seat car utilizes more than 150 SKF components. Lessons learned here are applied to the product we provide to automakers and the aftermarket worldwide.

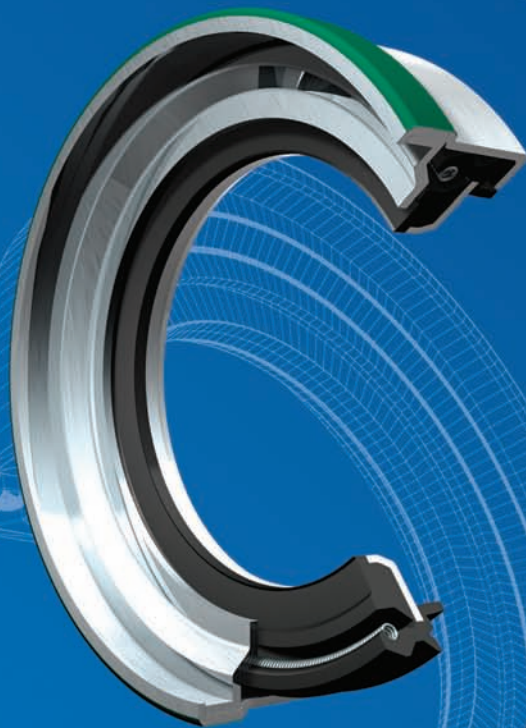
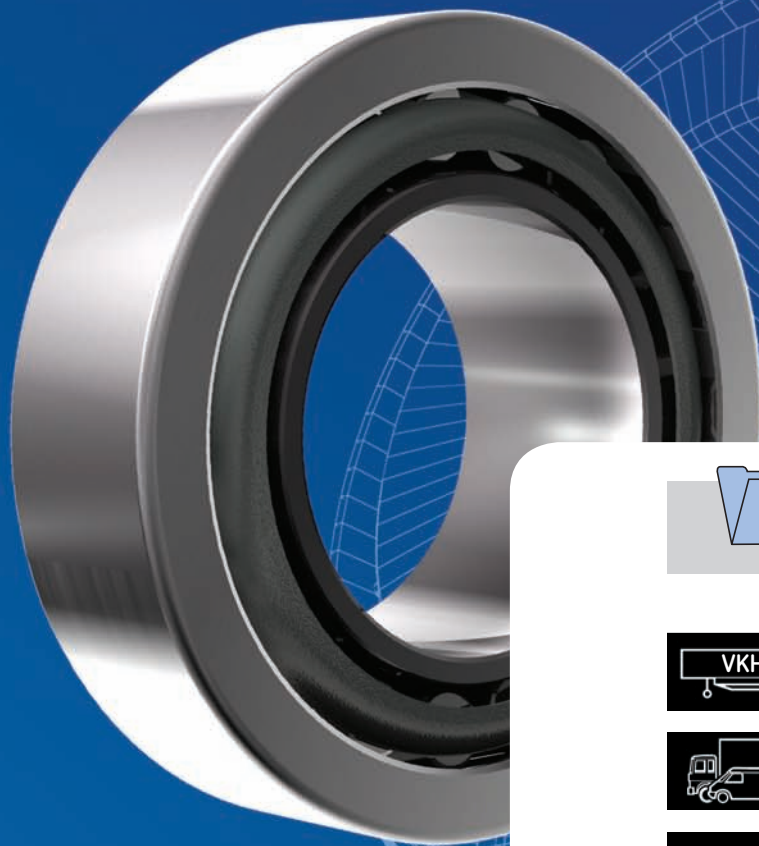

 1
 5
 10
 254
 280
 292
VKBA=? 298
 299
 308
 318
 322
 323

Install confidence

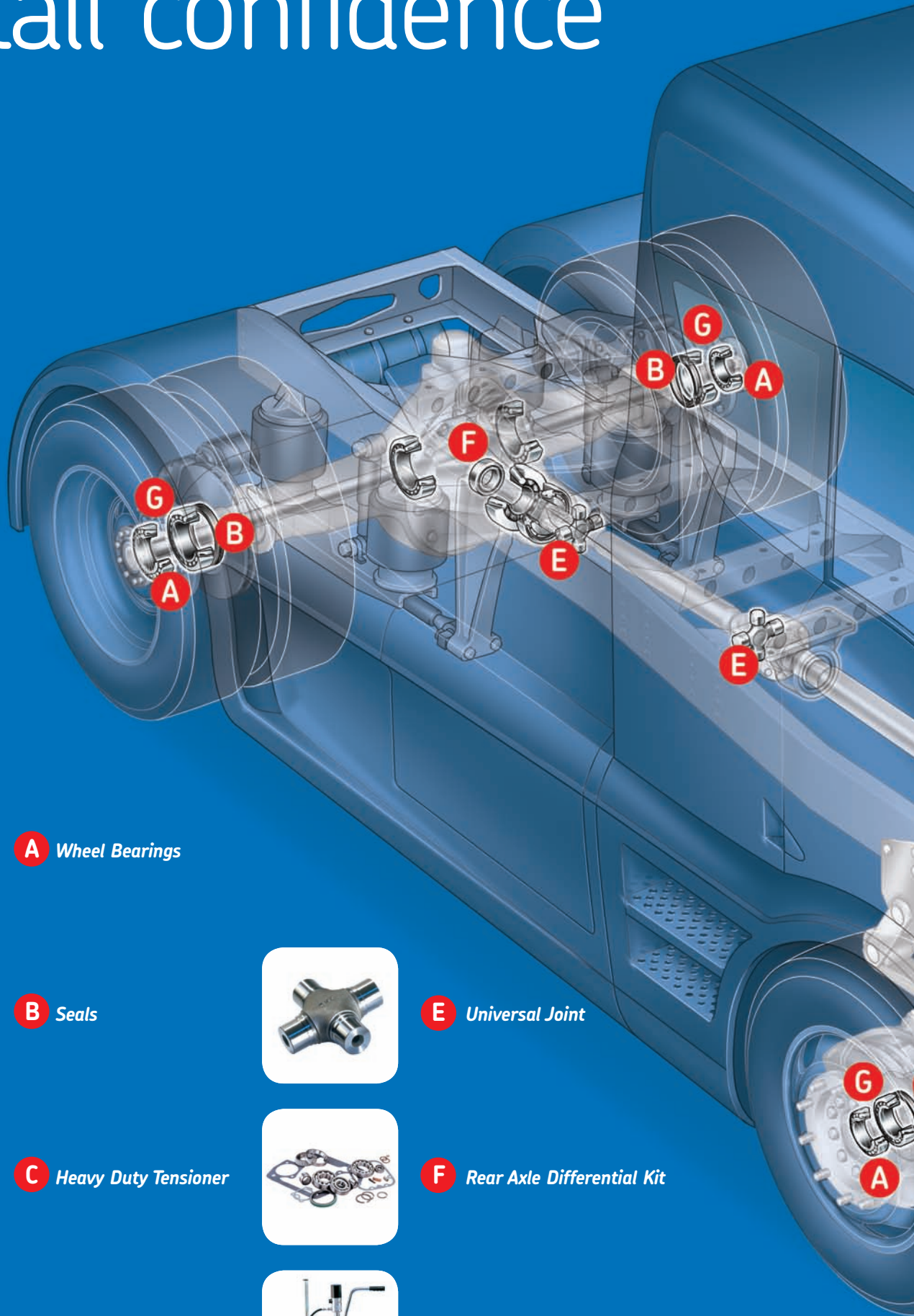

A *Wheel Bearings*



B *Seals*



C *Heavy Duty Tensioner*



D *Transmission Bearings*



E *Universal Joint*



F *Rear Axle Differential Kit*



G *Grease*

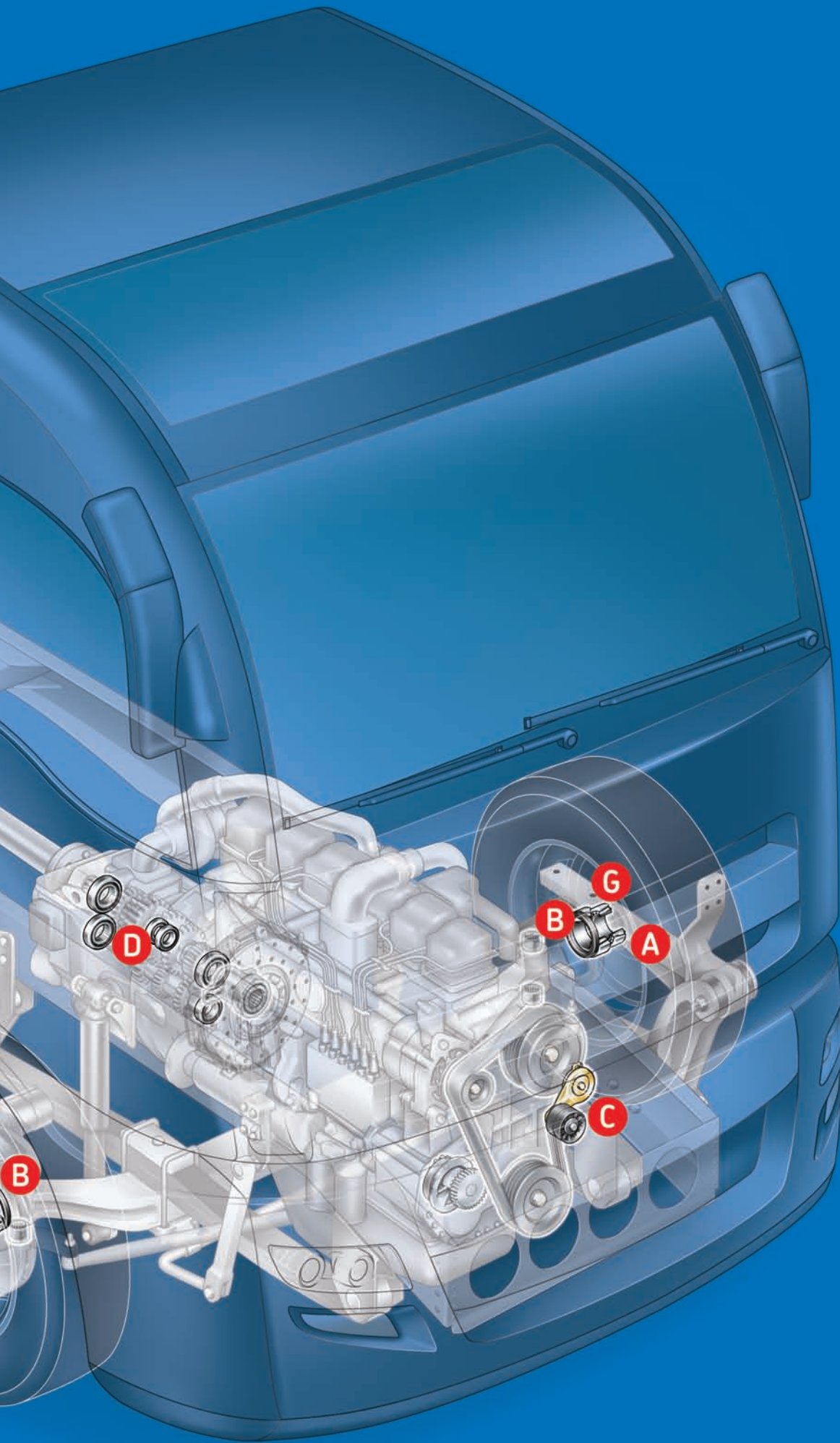



VKS



VKHB



VKBA

VKN TOOLS





VKHB 24XX S



ARVIN MERITOR (ROR)

TA / TC Series

- VKHB 2407 S BT1-0534 B (HM 218248/210)
- VKHB 2407 S BT1-0534 B (HM 218248/210)

TE 9000, TE 9300

- -
- VKHB 2401 S BT1-0510 A (32310)

TM 22000, TM 22500, TM 25000

- VKHB 2407 S BT1-0534 B (HM 218248/210)
- VKHB 2405 S BT1-0517 (33213)

TM 33000

- -
- VKHB 2410 S BT1-0509 B (32218)

BPW

ZRZ-8010, EHZ-9010

- 1973-82
- VKHB 2406 S BT1-0533 A (33215)
 - VKHB 2401 S BT1-0510 A (32310)

ZRZ-10010

- 1973-77
- -
 - VKHB 2405 S BT1-0517 (33213)

ERZ-10010, EHZ-11010

- 1977-82
- -
 - VKHB 2405 S BT1-0517 (33213)

HL/HLS 6,5 - 9 tons

- 1982-
- VKHB 2403 S BT1-0515 (33116)
 - VKHB 2401 S BT1-0510 A (32310)

H/R, KH/KR, NH/NR 6,5 - 9 tons
ECO / ECO MAXX 6,5-9 tons

- 1993-
- VKHB 2403 S BT1-0515 (33116)
 - VKHB 2401 S BT1-0510 A (32310)

SH/SKH, ECO 8-9 tons

- VKHB 2403 S BT1-0515 (33116)
- VKHB 2401 S BT1-0510 A (32310)

H/KH, SH/SKH ECO-Plus, 8-9 t

- VKHB 2404 S BT1-0516 (33118)
- VKHB 2405 S BT1-0517 (33213)

HL/HLS 10 - 12 tons
SH/ SKH ECO 10-12 tons

- VKHB 2404 S BT1-0516 (33118)
- VKHB 2405 S BT1-0517 (33213)

H/R, KH/KR, NH/NR 10-12 tons
ECO / ECO MAXX 10 - 12 tons
SH/SKH ECO Plus, 10-12 tons

- VKHB 2404 S BT1-0516 (33118)
- VKHB 2405 S BT1-0517 (33213)

H/K, ECO 13-14 T. NR, 13 tons

- -
- VKHB 2406 S BT1-0533 A (33215)

FRUEHAUF

Propar axle (P-series)

- VKHB 2408 S BT1-0522 (HM 518445/410)
- VKHB 2408 S BT1-0522 (HM 518445/410)

GIGANT (SAE)

DH6 10008 3745

- 2001-
- VKHB 2404 S BT1-0516 (33118)
 - VKHB 2405 S BT1-0517 (33213)

DH5/6 09010 4345

- 1998-
- VKHB 2403 S BT1-0515 (33116)
 - VKHB 2401 S BT1-0510 A (32310)

DH6 09010 3745

- 2001-
- VKHB 2403 S BT1-0515 (33116)
 - VKHB 2401 S BT1-0510 A (32310)



DH6 10010 4345	2000-	● ●	VKHB 2404 S VKHB 2405 S	BT1-0516 (33118) BT1-0517 (33213)
DNH6 10008 3745	2001-	● ●	VKHB 2404 S VKHB 2405 S	BT1-0516 (33118) BT1-0517 (33213)
GVH5/6 09010 4218	1999-	● ●	VKHB 2403 S VKHB 2401 S	BT1-0515 (33116) BT1-0510 A (33210)
GVH5 10010 3020 , GVH5 12010 3020	2000-	● ●	VKHB 2404 S VKHB 2405 S	BT1-0516 (33118) BT1-0517 (33213)
GVH5 10008 3620, GVH5 10010 3620	1997-	● ●	VKHB 2404 S VKHB 2405 S	BT1-0516 (33118) BT1-0517 (33213)
GVH5 12008 3620 , GVH5 12010 3620 , GVH5 10010 4220	2000-	● ●	VKHB 2404 S VKHB 2405 S	BT1-0516 (33118) BT1-0517 (33213)
GVH5 12010 4220	1997-	● ●	VKHB 2404 S VKHB 2405 S	BT1-0516 (33118) BT1-0517 (33213)

KÄSSBOHRER

10 tons, 09-01.030, 09-01.062, 09-01.075, 09-01.077, 09-01.089, 09-01.093, 09-01.100

- VKHB 2410 S BT1-0509 B (32218)
- VKHB 2409 S BT1-0507 B (32216)

9 tons, 09-01.111, 09-01.112, 09-01.113, 09-01.114, 09-01.119, 09-01.121, 09-01.122

- -
- VKHB 2409 S BT1-0507 B (32216)

MONTENEGRO

11 ton , 11,5 ton AXLE
061001210 , 061001210B , 061001295 , 061001299, 0611100 , 0611102 , 0610006 , 0611108, 0611173 , 0611174

- VKHB 2408 S BT1-0522 (HM 518445/410)
- VKHB 2408 S BT1-0522 (HM 518445/410)

SAF

RZM 13130

- VKHB 2410 S BT1-0509 B (32218)
- -

RBM 8442, RLBM 8442, RSM 8442, RSM 8442-8, RSM 11242
RSLM 8442, RSLM 11242, RZM 8442, RZM 8442-8, RZM 11242
WRZM 8435-10, WRZM 8442, WRZM 8442-8, WRZM 11030
WRZM 11035-8, WRZM 11035-10, WRZM 11242, WRLZM 8130
WRLZM 8345-8, WRLZM 8435-10, WRLZM 11030
WRLZM 11035-8, WRLZM 11035-10, WZRLZM 8130
WZRLZM 11030, WRZM 8130, WRZM 11030

- VKHB 2407 S BT1-0534 B (HM 218248/210)
- VKHB 2405 S BT1-0517 (33213)

RBM 8442/12

- -
- VKHB 2405 S BT1-0517 (33213)

RLSM 9042, RLSM 9042/20, RSM 6542, RSM 9042, RSM 9042/20

-11/1995

- VKHB 2402 S BT1-0514 (32924)
- VKHB 2402 S BT1-0514 (32924)

SK 500, SK RS 9030
SK RZ 9030, SK RZ 11030

- VKHB 2407 S BT1-0534 B (HM 218248/210)
- VKHB 2405 S BT1-0517 (33213)

TRAILOR

L 200; L 300 TM; L400 TEM

- VKHB 2413 S BT1-0520 (JM 718149/110)
- VKHB 2412 S BT1-0519 (JM 515649/610)

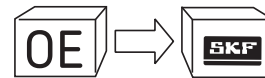
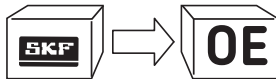

VKHB2401 S	BPW GIGANT (SAE)	02.6410.25.00 10500491
VKHB2402 S	SAF(SAUER)	4.200.1010.00
VKHB2403 S	ARVIN MERITOR (ROR) BPW	99041067B 02.6410.24.00
VKHB2404 S	BPW GIGANT (SAE)	02.6410.23.00 10500572
VKHB2405 S	ARVIN MERITOR (ROR) BPW GIGANT (SAE) SAF(SAUER)	99041045 B 02.6410.22.00 10500558 4.200.0060.00
VKHB2406 S	BPW	02.6410.29.00
VKHB2407 S	ARVIN MERITOR (ROR) SAF(SAUER)	99041035 B 4 200 1006 00
VKHB2408 S	FRUEHAUF	AJA 0813.001
VKHB2409 S	KÄSSBOHRER	6.691.159.000
VKHB2410 S	ARVIN MERITOR (ROR) KÄSSBOHRER SAF(SAUER)	99041057 6.691.161.000 4.200.0027.00
VKHB2412 S	FRUEHAUF	T6015000D000
VKHB2413 S	FRUEHAUF	T6014000T000

BPW	
02.6410.22.00	VKHB 2405 S
02.6410.23.00	VKHB 2404 S
02.6410.24.00	VKHB 2403 S
02.6410.25.00	VKHB 2401 S
02.6410.29.00	VKHB 2406 S

FRUEHAUF	
AJA 0813.001	VKHB 2408 S
T6014000T000	VKHB 2413 S
T6015000D000	VKHB 2412 S

GIGANT (SAE)	
10500491	VKHB 2401 S
10500558	VKHB 2405 S
10500572	VKHB 2404 S

KÄSSBOHRER	
6.691.159.000	VKHB 2409 S
6.691.161.000	VKHB 2410 S

MERITOR (ROR)	
99041035 B	VKHB 2407 S
99041045 B	VKHB 2405 S
99041057	VKHB 2410 S
99041067B	VKHB 2403 S

SAF (SAUER)	
4.200.0027.00	VKHB 2410 S
4.200.0060.00	VKHB 2405 S
4 200 1006 00	VKHB 2407 S
4.200.1010.00	VKHB 2402 S

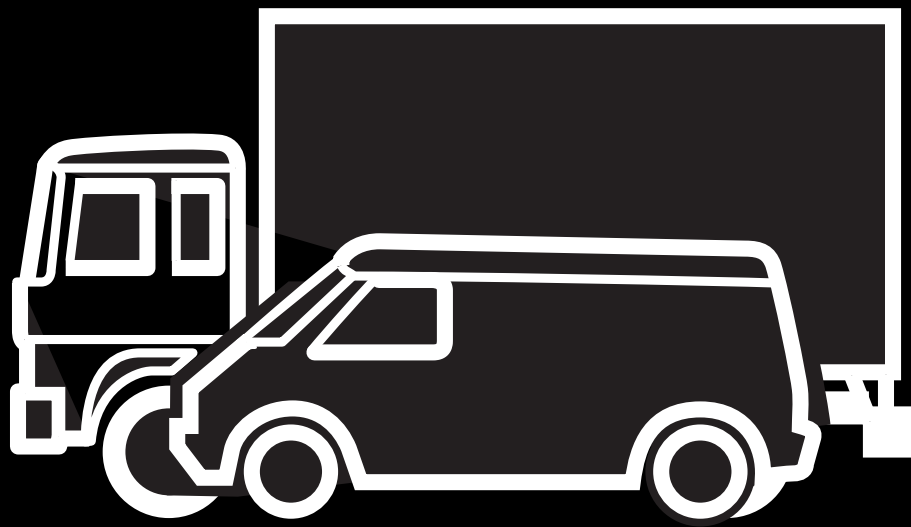



CITROËN

C 25	21
C 25, 1.8 E, 1.9 D, 2.0 E, 2.5 D Turbo	21
C 25, 1.9 TD, 2.0	21
4x4: C 25	21
C 25	21
4x4: C 25	21
Jumper, 1.9 D, 1.9 TD, 2.0, 2.0 HDi	21
Jumper, 2.0, 2.0 bivalent, 2.0 HDi, 2.2 HDi	21
Jumper, 2.5 TD, 2.5 TDi, 2.8 HDi	21
Jumper, 2.8 HDi	22
Jumper, 4x4: 1.9 TD, 2.0, 2.5 D, 2.5 TD, 2.5 TDi, 2.8 HDi	22
Jumper, 4x4: 2.8 HDi	22
Jumper, 1.9 D, 1.9 TD, 2.0, 2.0 HDi	22
Jumper, 2.0, 2.0 bivalent, 2.0 HDi, 2.2 HDi	22
Jumper, 2.5 TD, 2.5 TDi, 2.8 HDi	22
Jumper, 2.8 HDi	22
Jumper, 4x4: 1.9 TD, 2.0, 2.5 D, 2.5 TD, 2.5 TDi, 2.8 HDi	22
Jumper, 4x4:	22

DAF

Sherpa 285, 300, 310, 350	23
Sherpa 285, 310, 350 (MT 210)	23
F 400 Ser.	23
F 600 Ser.	23
F 800 Ser.	23
F 1000 Ser.	23
F 1300 Ser.	23
F 1600 Ser.	23
F 1700 Ser.	23
F 1900 Ser.	24
F 2000/2005 Ser.	24
F 2100/2105 Ser.	24
F 2300/2305 Ser.	24
F 2500/2503/2505 Ser.	24
F 2700 Ser.	25
F 2800 Ser.	25
F 2900 Ser.	25
F 3200 Ser.	25
F 3300/3305 Ser.	25
F 3600 Ser.	26
F 95 Ser.	26
N 2800 Ser.	26
LF 45	26
LF 55	26
65 CF	26
75 CF	27
85 CF	27
95 XF	27
95 XF.530	27

FIAT IVECO

242	28
Talento	28
Ducato 13	28
Ducato I 10	28
Ducato I 14	28
Ducato I Maxi 18	29
Ducato II 10 4x2	29
Ducato II 10 4x2	29
Ducato II 10 4x4	29
Ducato II 14 4x2	29
Ducato II 14 4x4	29
Ducato II 18 4x2	29
Ducato II 18 4x4	29

Ducato III JTD	29
Ducato III 2.0, 2.0 Bipower, 2.3 JTD, 2.8 JTD	29
Ducato III 4X4	29
Ducato III	30
Daily 1 28-8	30
Daily 1 30-8	30
Daily 1 30-9	30
Daily 1 32-8	30
Daily 1 35-8	30
Daily 1 35-8 H. DUTY	31
Daily 1 35-9	31
Daily 1 35-10	31
Daily 1 35-10 Turbodayly	31
Daily 1 35-12 Turbodayly	31
Daily 1 40-8	32
Daily 1 40-8 H. DUTY	32
Daily 1 45-10	32
Daily 1 49-10	32
Daily 1 49-10 Turbodayly	32
Daily 1 49-12 Turbodayly	32
Daily 1 59-12 Turbodayly	33
Daily II 29L10	33
Daily II 29L12	33
Daily II 35C9	33
Daily II 35C10	33
Daily II 35C11	33
Daily II 35C12	33
Daily II 35C13	33
Daily II 35C15	33
Daily II 35S9	34
Daily II 35S10	34
Daily II 35S11	34
Daily II 35S12	34
Daily II 35S13	34
Daily II 35S13 Bus	34
Daily II 35S15	34
Daily II 40C13 Bus	34
Daily II 40C15 Bus	34
Daily II 50C11	34
Daily II 50C11 Bus	35
Daily II 50C13	35
Daily II 50C13 Bus	35
Daily II 50C15	35
Daily II 50C15 Bus	35
Daily II 65C11	35
Daily II 65C13	35
Daily II 65C15	35
Grinta: 28-8	35
Grinta: 30-8	36
Grinta: 30-9	36
Grinta: 32-8	36
Grinta: 35-8	36
Grinta: 35-9	36
Grinta: 40-8	36
Grinta Ser S: 30-9, 35-8, 35-10, 40-8, 40-10	37
Grinta Ser S Turbo: 45-10, 16710	37
100E15, 100E18, 100E21 Eurocargo	37
100E17, 100E18, 100E21 TECTOR, RESTYLING EUROFIRE TECTOR E.FIRE RESTYLING	37
109-14, 109-14 CKD,	37
109-14 Zeta	38
110-13A	38
110-16 A, 110-16 AH	38
115-14 (I-II-Serie), 115-17 (I-II-Serie), 115-17 H (I-II-Serie)	38
115-17 (II-Serie)	38
120-13 (II-Serie), 120-14 (II-Serie)	38



120-17ANW	38	190-25 (256 M19), 190-29 (290 M19), 190-32 (320 M19), 190-36 (360 M19)	46
120E15 EUROARGO	39	190-26 HW (4x4), 190-30 HW	46
120E21H EUROARGO	39	190-26 Turbotech	46
130-13 A, 130-13 AH, 130-16 A, 130-16 AH	39	190-30 H CKD	46
130-M7 FAL CKD	39	190-30 N, 190-30 NT	46
130E15, 130E18, 130E23 Eurocargó	39	190-30 PT GR. VOL., 190-30 T T/Range, 190-30 T EKO (T-UN), 190-30 P T/Range, 190-30 PT T/Range, 190-30 PT GR. VOL.T	47
130E18, 130E21, 130E24, 130E28 TECTOR, RESTYLING 130E24 EUROFIRE TECTOR, E.FIRE RESTYLING	39	190E31 (4x2), 190E42 (4x2) Eurotrækker	47
130E18, 130E24, 130E28 TECTOR	40	190E31 (4x4), 190E42 (4x4) Eurotrækker	47
130E21, 130E24, 130E28 TECTOR RESTYLING 130E24 E. FIRE RESTYLING	40	190-32 P GR. VOL., 190-32 PT GR. VOL.	47
135-14 H, 135-14 (H) CKD, 135-14 H CKD, 135-17 (H), 135-17 T, 135-17 H, 135-17 (HO CKD), 135-17 H CKD	40	190-35	47
135-17 (I-Serie), 135-17 (II-Serie), A 135-17 (II-Serie)	40	190-36 T T/Star, 190-36 P T/Star, 190-36 T T/Range, 190-38 (T-UN), 190-38 T (T-UN)	47
135E18 (4x4), 135E23 (4x4) Eurocargó	40	190-36 T/Range, 190-36 PT T/Star, 190-36 P T/Range, 190-36 PT T/Range, 190-36 T/Star,	47
135E21 EUROARGO 135E22W EUROFIRE 135E24W EUROFIRE	40	190-42, 190-42 T, 190-42 P H	48
140-14 (II-Serie), 140-20 (II-Serie)	40	190E24 EUROMOVER	48
140E18, 140E24 TECTOR RESTYLING 140E24 EUROFIRE TECTOR 140E28 EUROFIRE TECTOR 140E28 E.FIRE RESTYLING	40	190E24, 190E27, 190E30 Eurotech	48
145-17 (II-Serie)	41	190E24, 190E31 Eurotech CURSOR	48
150-14 (II-Serie), 150-16 A (II-Serie), 150-17 (I-Serie), 150-17 (II-Serie)	41	190E30 ÎMPÎ Eurotech	48
150E18, 150E21, 150E24, 150E28 TECTOR, TECTOR RESTYLING ..	41	190E30 ÎMTÎ, 190E34 Eurotech	48
150E18 TECTOR	41	190E30, 190E34 Eurotrækker	49
150E21, 150E24, 150E28 TECTOR RESTYLING	41	190E35 Eurotech CURSOR	49
150E24, 150E27, 150E28 EUROFIRE, EUROFIRE TECTOR, E.FIRE RESTYLING	41	190E37 Eurotrækker	49
150E28 E.FIRE RESTYLING	41	190E38 Eurostar	49
150E15, 150E18, 150E23, 150E27 Eurocargó	41	190E38 Eurotech	50
150E15 H, 150E18 H, 150E21 H, 150E23 H Eurocargó	42	190E42 Eurotech	50
159-17 (I-Serie), 159-17 B (II-Serie), 159-20 (I-Serie)	42	190E42, 190E47, 190E52 Eurostar	50
160-16 A (II-Serie)	42	190S40, 190S43, 190S48 AS STRALIS	50
160-17-AN-ANW	42	190S27, 190S30, 190S31, 190S35, 190S40, 190S43 AD STRALIS .	50
160-23 AH	42	190S27, 190S31, 190S35, 190S40, 190S43 AT STRALIS	50
160-23 ANW (4x4), 160-23 AHW (4x4)	42	220-30 PT (6x2)(T-UN), 220-36 P (6x2) T/Range, 220-36 PT (6x2) T/Range	51
160-26	42	220-30 T.R.U. (-01/85), 220-36 (-04/87), 220-38 T.R.U. (-01/85) -	51
160-30 AHW	42	220-32 AHT	51
165-24 (II-Serie)	42	220-32 Turbotech, 220-36/38 Turbotech G.V.	51
170E15, 170E18, 170E23, 170E27 Eurocargó	43	220-36 (360 M22), 220-38	51
170-23AH-AHW	43	230-35 WM (6x6)	51
170-25-AH-AHW	43	240-26 Turbotech, 240-36/38 Turbotech, 240-32 Turbotech G.V., 240-36 Turbotech G.V., 240-48 Turbostar	51
170-34AH-AHW	43	240-26 T.R.U. (-06/88), 240-30 (-01/85), 240-30 T.R.U. (01/85), 240-36 (-04/87), 240-36 T.S. (-06/88) ...	52
170/190-20, 170/190-26, 170/190-35	43	240-26, 240-30 P (6x2) (T-UN), 240-36, 240-36 T/Star, 240-36 P (6x2) T/Range, 240-42 T/Star	52
175-17	43	240-30, 240-38	52
175-24	43	240E30 Eurotech	52
180E21 Eurocargó	44	240E34 Eurotech	52
180E24, 180E27, 180E30, 180E34 ÎMPÎ, 180E34 ÎMTÎ Eurotech	44	240E38 Eurostar	53
180E25 (4x4) Eurotrækker	44	240E42, 240E47, 240E52 Eurostar	53
180E27	44	260-25 AH (6x4), 260-30 AH (6x6), 260-32 AH Army, 260-35 HM (6x4), 260-35 HM (6x6)	54
180E38 Eurostar	44	260-25 AHW (6x6), 260-26 NW (6x6), 260-35 HWM (6x6), 260-35 WM (6x6)	54
180E38 Eurotech	45	260-32 Turbotech, 260-36/38 Turbotech, 260-36/38 Turbostar, 260-48 Turbostar	54
180E42 Eurotech	45	260-36 T/Star, 260-36 T T/Star, 260-42 T/Star, 260-42 T T/Star	54
180E21, 180E24, 180E28 TECTOR RESTYL	45	260E23 Eurocargó	54
180E21, 180E24, 180E28 TECTOR	45	260E24 EUROMOVER	54
190-24 Turbotech	45	260E28KE TECTOR 260E28 TECTOR RESTYL.	55
190-24 T.R.U. (-06/88), 190-30 T.R.U. (-01/85), 190-30 G.V. (-06/88), 190-36 T-Range UNIF (-04/87), 190-38 (-01/85), 190-38 T.R.U. (-01/85)	45	260E24 (6x2), 260E31 (6x2), 260 E35 (6x2) Eurotech CURSOR	55
190-24, 190-26 Turbotech, 190-30, 190-32 Turbotech, 190-36/38 Turbotech, 190-32 Turbotech G.V., 190-36 Turbotech G.V., 190-36/38 Turbostar, 190-42/48 Turbostar	46	260E30 (6x4), 260E34 (6x4) Eurotrækker	55
190-25 ANW (4x4)	46	260E31 (6x4), 260E35 (6x4) Eurotrækker CURSOR	55
190-25 AN, 190-25 ANT, 190-25 AN CKD, 190-25 AN (TAM), 190-26 H CKD, 190-26 H, 190-26 HT, 190-26 N (C.B.5), 190-26 NT (C.B.5), 190-26 N CKD, 190-25 AHT	46	260E38, 260E44, 260E48 E.TRAK CURSOR	56



260E39 E.STAR CURSOR	56	440E42 (6x4) Eurotech	66
260E37 (6x4) Eurotrækker	56	440E42 (6x4), 440E52 (6x4) Eurostar	67
260E38, 260E42 Eurotech	56	440S40, 440S43, 440S44 440S48, 440S54 STRALIS	67
260E42, 260E47, 260E52 Eurostar	56	440S40, 440S43, 440S48, 440S54 AS STRALIS	67
260E42 (6x4) Eurotrækker	57	440S31, 440S35, 440S40, 440S43 AD STRALIS	67
260E42 (6x6) Eurotrækker	57	440S31, 440S35, 440S40 440S43 AT STRALIS	67
260E47 (6x4) Eurotrækker	57	440S31, 440S40, 440S43 AT STRALIS	67
260S40, 260S43, 260S44 260S48, 260S54 STRALIS	57	50-9	67
260S43, 260S40, 260S48, 260S54 AS STRALIS	57	50-9 Zeta, 50-10 Zeta	67
260S27, 260S30, 260S31, 260S35, 260S40, 260S43 AD STRALIS ..	57	55-8 (I-Serie), 55-9 (I-Serie), 55-10 (I-Serie), A 55-10 (I-II-Serie) ..	68
260S27, 260S31, 260S35 260S40, 260S43 AT STRALIS	57	60-11 Turbozeta	68
280E23 Eurocargo	58	60-8 (III-Serie), 60-10 (I-II-Serie), A 60-10 (I-II-Serie)	68
300-30 AH (8x4)	58	60E10, 60E12, 60E14, Eurocargo	68
300-32AH, 300-34AH	58	619 T 1P, 619 N 1P CKD	68
320 D 26 AK CKD	58	65-9, 65-9 Export CKD, 65-12, 65-12 H, 65-12 V, 65-12 D	68
320-45 HWM (6x6),	58	65E10, 65E12, 65E12H 65E14 Eurocargo	68
320E27 Eurocargo	58	70-10 (I-Serie), A 70-12 (I-II-Serie), A 70-14	69
320E28T TECTOR	58	70-14 Zeta	69
325E27 Eurotech	59	720E31 (6x4), 720E37 (6x4), 720E42 (6x4),	
330-25 AN (TAM), 330-26 H (6x4), 330-26 HT (6x4)		720E47 (6x4) Eurotrækker	69
330-30 H (6x4), 330-30 HT (6x4), 330-30 H CKD,		720E31 (6x6), 720E37 (6x6), 720E42 (6x6) Eurotrækker	69
330-30 HT (6x4) CKD, 330-30 H (6x4) CKD, 330-30 N,		75-9A	69
330-35 H (6x4), 330-35 H (6x4) CKD, 330-35 HT (6x4)	59	75-13 AW, 75-16 AW	69
330-26 HW (6x6), 330-26 HWT (6x6), 330-30 HW (6x6),		75-13 WM (4x4), 75-14 WM	69
330-30 NW (6x6), 330-30 ANW (6x6), 330-32 ANW (6x6),		75E12, 75E14, 75E15 Eurocargo	70
330-35 HW (6x6), 330-35 HW (6x6) CKD	59	75E13, 75E15, 75E17. 75E18 TECTOR, RESTYLING, 75E17	
330E34 (6x4), 330E37 (6x4) Eurotrækker	59	EUROFIRE TECTOR	70
340E34 (8x4), 340E37 (8x4), 340E42 (8x4) Eurotrækker	59	79-11, 79-12 D, 79-12 V, 79-14, 79-14 D, 79-14 V,	
340E35 (6x4) Eurotrækker CURSOR	60	79-12 CKD	70
340E42 (6x6) Eurotrækker	60	79-12 Turbozeta	70
380E31 (6x4), 380E37 (6x4), 380E42 (6x4),		79-14 ZETA	70
380E47 (6x4) Eurotrækker	60	80-13 AW (4x4), 80-16 AW (4x4)	71
380E31 (6x6), 380E37 (6x6), 380E42 (6x6) Eurotrækker	60	80-13 A, 80-13 AH, 80-13 AT, 80-16 A	71
380E34 (6x4), 380E42 (6x4) Eurotrækker	60	80-13 (I-Serie)	71
380E35 (6x4) Eurotrækker CURSOR	60	80-14 W, 80-17 W	71
380E38, 380E44, 380E48 E.TRAK CURSOR	61	80E15, 80E18, 80E21, Eurocargo	71
400E30, 400E34 ðMPÏ 400E34 ðMTÏ Eurotech	61	85E15, 85E18, 85E18H Eurocargo	71
400E31 (4x2), 400E34 (4x2), 400E37 (4x2),		90-13 A (01/85-), 90-13 AH (01/85-), A 90-14 (III-IV-Serie)	71
400E42 (4x2) Eurotrækker	61	90-13 (I-II-Serie), A 90-13 (I-II-Serie)	71
400E31 (4x4), 400E37 (4x4) Eurotrækker	61	90-14 WM (4x4), 90-17 WM	72
400E34 Eurotrækker	61	90-16 AW	72
400E35, 400E38, 400E44 E.TRAK CURSOR	61	95-14 Zeta	72
400E38 Eurostar	62	95-14 (III-IV-Serie)	72
400E38 Eurotech	62	95E15 (4x4), 95E21 (4x4) Eurocargo	72
400E42 Eurotech	62	95E18 Eurocargo	72
400E42, 400E52 Eurostar	62	95E18W EUROFIRE 95E21 EUROCARGO	72
400E47 EUROSTAR	62	A 135-14 (5000), A 135-14 (5000) CKD, A 135-17 (4400) CKD,	
40-10 W S, 40-10 W (4x4), 40-10 W V, 40-10 W C,		A 135-17 (5000)	72
40-10 W D	63	A175-24 175-17, 175-24, 175-24 T, 175-24 Nett. URB.,	
40-10 WM (4x4)	63	175-24 CKD	73
410E35 (6x4) Eurotrækker CURSOR	63	Z 220, Z 220 Stripped chass., Z 220 T H	73
410E38, 410E44, 410E48 E.TRAK CURSOR	63	Z Range:50-8	73
410E37 (8x4), 410E42 (8x4) Eurotrækker	63	Z Range: 60-10, 65-10 75-10, 79-10, 79-14	73
410E42 (6x6) Eurotrækker	63		
440E31, 440E35 Eurotech CURSOR	64		
440E34 Eurotech	64		
440E38 EUROTECH	64		
440E34 (6x4), 440E42 (6x4) Eurotrækker	64		
440E37 (6x4) Eurotrækker	64		
440E38, 440E44 E.TRAK CURSOR	65		
440E38 Eurostar	65		
440E39, 440E43 Eurotech Cursor	65		
440E42 (4x2) Eurotech	65		
440E42 (4x2), 440E47 (4x2), 440E52 (4x2) Eurostar	65		
440E39, 440E43, 440E46, 440E48 E.STAR CURSOR	66		
440E42 (6x2) Eurotech	66		

FORD

P 100 1,6	73
P 100	73
Transit I FT 60-80 (GB)	73
Transit I FT 60-120 (D)	73
Transit I FT 80-120	73
Transit I FT 90-120 (GB)	74
Transit I FT 100L (D)	74
Transit I FT 100L, Transit FT I 130-190	74
Transit FT I 100L, Transit FT I 130-190	74
Transit I FT 120-190	74
Transit I FT 125-190	74



Transit I FT 130-190	74
Transit I FT 130-150, 190 L	74
Transit II	74
Transit II 2.0 DI, 2.0 TDCi, 2.3 16V, 2.4 DI, 2.4 TDE	75
Transit II	75
CARGO	75

MAN

6/8 T 4x2 F, (Type L01)	75
8/9 T 4x2 FOC, (Type L05)	75
10 T, 4x2 F, (Type L04)	75
12 T 4x4 FA, (Type M07)	76
12/13 T, 4x2 FL, (Type M02)	76
12/13 T, 4x2 F, (Type M01)	76
14/15 T, 4x2 FL, (Type M04)	76
14/15 T, 4x2 F, (Type M03)	76
16/19 T, 4x2 FLL, (Type F03)	76
16/19 T, 4x2 FL, (Type F02)	77
16/19 T, 4x2 F, (Type F01)	77
16/19 T, 4x2 U (Type U01)	77
17/18 T, 4x2 FL, (Type M06)	77
19 T 4x2 FL, (Type F22)	77
19 T 4x2 F, (Type F21)	78
22/24/25/26 T, 6x2 FNLL, (Type F06)	78
22/24/25/26 T, 6x2 FNL, (Type F25)	78
22/24/25/26 T, 6x2 UNL, (Type U15)	78
22/24/25/26 T, 6x2/4 FVL, (Type F07)	78
24 T 6x2 FNL, (Type M09)	78
24 T, 6x2/4 FVL, (Type M10)	79
26 T, 4x2 FNLL, (Type F19)	79
26/27/28/30/32/33 T, 6x6 DFA, (Type F10)	79
26/27/28/32/33 T, 6x4 DF, (Type F09)	79
32/35/41 T, 8x8/4-8x6/4, 8x4/4, (Type E15)	80
38/40 T, 6x6 DFA, (Type F12)	80
40 T 6x4 DF, (Type F11)	80
41 T 8x8/4, 8x6/4 VFA, (Type E15)	80
L, M, F 2000 Ser.	81
TGA 18 T 4x2 BLS-TS D28	82
TGA 18 T 4x4 BB D28	82
TGA 19 T 4x2 BBS-WW D28	82
TGA 24 T 6x2-2 LL-U D28	82
TGA 26 T 6x2-2, 6x2-4 BL D28	82
TGA 26/33 T 6x4 BB D28	82
TGA 26/33 T 6x6 BB D20	83
TGA 28 T 6x2-4 BL/LL D28	83
TGA 32 T 8x4 BB D28	83
TGA 33 T 6x2-2 BL D28	83
TGA 35 T 8x4 BB D28	83
TGA 40 T 6x6 BB-WW D28	83
TGA 35/41 T 8x6 BB D28	84
TGA 41 T 8x4/4 BB/BL D28	84
TGA 41/50 T 8x4 BB-WW D28	84

MERCEDES-BENZ

100	84
100, D,D (631.332, 333, 334, 340, 342, 343, 344)	84
100 D (631.340)	84
HENSCHEL 2-t, 207 1.8	84
SPRINTER 2-t	84
SPRINTER 3-t	85
SPRINTER 4-t	85
V-CLASS	85
VITO, 113 2.0 (638.014), 108 CDI 2.2, 112 CDI 2.2, 108 D 2.3 (638.064), 110 D 2.3 (638.074) 110 TD 2.3 (638.174), 114 2.3 (638.034.134)	85

T1, 207 D, 208, 208 D, 209 D, 210, 210 D, 212, 214, 215	85
T1, 307 D, 308, 308 D, 309, 309 D, 310, 310 D, 312, 314, 315	85
T1, 307 D, 308, 308 D, 309, 309 D, 310, 310 D, 312, 314, 315	85
T1, 307 D, 308, 308 D, 309, 309 D, 310, 310 D, 312, 314, 315	85
T1, 406, 406 D, 407, 407D, 408, 408 D, 408 G, 409, 409D, 410, 410 D, 412, 414, 415	85
T1, 500 Ser.	86
T2, 600 Ser.	86
LK, 700 Ser.	87
LK, 800 Ser.	87
LK, 900 Ser.	88
LK, 1000 Ser.	89
LK, 1100 Ser.	90
LK, 1200 Ser.	90
LK, 1300 Ser.	91
LK, 1400 Ser.	92
LK, 1500 Ser.	93
SK, 1600 Ser.	94
SK, 1700 Ser.	97
SK, 1800 Ser.	98
SK, 1900 Ser.	100
SK, 2000 Ser.	102
SK, 2200 Ser.	104
SK, 2300 Ser.	107
SK, 2400 Ser.	107
SK, 2500 Ser.	109
SK, 2600 Ser.	112
SK, 2800 Ser.	114
SK, 3000 Ser.	114
SK, 3200 Ser.	115
SK, 3300 Ser.	116
SK, 3500 Ser.	117
SK, 3600 Ser.	118
SK, 3800 Ser.	118
SK, 4000 Ser.	118
SK, 4100 Ser.	119
SK, 4400 Ser.	119
SK, 4800 Ser.	119
SK, 5000 Ser.	120
SK, 6000 Ser.	120
ATEGO, 700 Ser.	120
ATEGO, 800 Ser.	121
ATEGO, 900 Ser.	121
ATEGO, 1000 Ser.	121
ATEGO, 1200, 1300, 1500 Ser.	122
ATEGO, 1800 Ser.	122
ATEGO, 2500 Ser.	123
ATEGO, 2600 Ser.	124
ACTROS, 1800 Ser. AXOR, 1835, 1840, 1843	124
ACTROS, 1900 Ser.	125
ACTROS, 2000 Ser.	126
ACTROS, 2500 Ser.	127
ACTROS, 2600 Ser.	128
ACTROS, 3200 Ser.	129
ACTROS, 3300 Ser.	130
ACTROS, 4100 Ser.	130

MERCEDES-BENZ "Baumuster"

730.001-002, 730.004	131
730.005	131
730.006-010	131
730.011-012	131
730.016-019	131
730.020	131
730.021	131
730.022	131



730.030-031	132	739.096-099	136
730.034	132	739.100	136
730.036, 730.039	132	739.102, 739.104	136
730.041, 730.043	132	739.105-106, 739.109	136
730.044	132	739.110-111	136
730.045	132	739.112	136
730.048	132	739.113	137
730.050	132	739.114	137
730.052, 730.056-060, 730.062-066	132	739.115	137
730.100-101	132	739.116-117	137
730.200, 730.230-231	132	739.118-120	137
730.403-404	132	739.121-123	137
730.405, 730.407-414	132	739.130-131	137
730.445-446	132	739.133-134	137
730.447-448	132	739.136	137
730.502	133	739.137	137
730.503-504	133	739.138	137
730.505	133	739.139	137
730.506	133	739.140	137
730.531	133	739.140-145	137
730.532	133	739.146-149	138
730.533	133	739.150-157	138
730.534-535	133	739.158-159	138
730.600-603, 730.630	133	739.160	138
730.702	133	739.161	138
730.703-704	134	739.162	138
730.705	134	739.163-165	138
730.706	134	739.166-173	138
730.708-709	134	739.174-175	138
730.713-714	134	739.177-178	138
730.023-024	134	739.179-181	138
730.730	134	739.182-184	138
730.731	134	739.187-188, 739.190	138
730.732	134	739.191-195	138
730.733	134	739.197-198	138
730.736	134	739.199, 739.207, 739.209	139
730.800	134	739.400-401	139
730.801	134	739.410-411	139
730.802, 730.830-832	134	739.430-431, 739.434	139
731.000, 731.002, 731.004-009, 731.012, 731.031-033, 731.035-037, 731.044-045, 731.048-057	134	739.500, 739.510, 739.520, 739.530-531, 739.540-543, 739.550	139
731.700	135	739.560, 739.570	139
731.720	135	740.000	139
739.001-003	135	740.001	139
739.006	135	740.002	139
739.007, 739.016-019, 739.030-031	135	740.003	139
739.032	135	740.004	140
739.033	135	740.005	140
739.034, 739.036	135	740.006-007	140
739.037-039	135	740.008	140
739.040-047	135	740.009	140
739.048-049	135	740.030	140
739.050, 739.052-053	135	740.031	140
739.054-055	135	740.033-034	140
739.056-061, 739.064, 739.066, 739.070	135	740.035-037	140
739.071-072	135	740.039-043	140
739.073-074, 739.076-081	136	740.045	141
739.082	136	740.047-051	141
739.083	136	740.053	141
739.084	136	740.054-056	141
739.086	136	740.057-058	141
739.087-088	136	740.059-064	141
739.089-092	136	740.065-071	141
739.093	136	740.072	141
739.094	136	740.074	141
		740.100-104	141



740.105	142	740.501	148
740.106	142	740.502	148
740.107	142	740.530-532	148
740.109	142	740.536-538	148
740.110-113	142	740.539	148
740.114	142	740.540	148
740.115-117	142	740.544	149
740.119	142	740.545-548	149
740.130-133	142	740.901	149
740.134-135	142	740.903-906	149
740.136	143	740.908	149
740.138-139	143	740.909	149
740.140-147	143	740.909-910	149
740.148	143	740.910	149
740.149-155	143	740.911	149
740.157	143	740.912	149
740.159-172	143	740.914-916	149
740.174-175	143	740.914-920	150
740.176-179	143	740.917	150
740.180	143	740.918-920	150
740.181-184	144	740.921-929	150
740.185-192	144	740.931	150
740.195-198	144	740.932	150
740.301-302	144	740.935	150
740.304	144	740.936	150
740.305	144	740.952-953	150
740.306-307	144	740.954	150
740.308	144	740.955	150
740.309-310	144	740.956-957	151
740.311-312	144	740.958-959	151
740.313	145	740.960	151
740.314	145	740.961-963	151
740.318-319	145	740.964	151
740.330-333	145	740.965-966	151
740.334	145	740.968	151
740.334-335	145	740.974	151
740.335	145	741.200-.203, 741.300-.304, 741.330-337	151
740.335-336	145	741.400-401, 741.404, 741.406, 741.436-439	151
740.336	145	741.520-521, 741.526-530, 741.540	151
740.337	145	741.550, 741.559	152
740.338-339	145	741.560, 741.570	152
740.340	145	741.580	152
740.341	146	742.001-002	152
740.342	146	742.100	152
740.346	146	742.201-.204, 742.230	152
740.347	146	742.300	152
740.348	146	742.400, 742.410-.414	152
740.350-351	146	742.420-421, 742.430, 742.432-443	152
740.352-354	146	742.450, 742.460-462	152
740.356-357	146	742.470-471, 742.480-487	152
740.364-366	146	742.503	152
740.367-368	147	744.300-302	152
740.369	147	744.303-305	152
740.370-372	147	744.309-311, 744.330-333	153
740.374-376	147	744.334, 744.336-338	153
740.380-382	147	744.339-340	153
740.383	147	744.341-342, 744.344-349	153
740.384-385	147	744.351	153
740.386	147	744.352, 744.400-402, 744.405, 744.407-.409,	
740.387-388	147	744.412-.414, 744.430, 744.432-433	153
740.392-393	147	744.434	153
740.394-395	148	744.435-437	153
740.396	148	744.438	153
740.397	148	744.442-443	153
740.398	148	744.500-502, 744.504-508, 744.530-532, 744.802-.804,	
740.500	148	744.807-.810, 744.830-.835, 744.842, 744.845,	





744.854-856, 744.863, 744.868-871, 744.876-877	153
744.900, 744.902-919	153
744.920	153
744.921	153
744.930, 744.932, 744.936-940, 744.942	154
744.947-949	154
744.950, 744.952-955, 744.957-960, 744.978-979,	
744.988-989	154
745.100-101, 745.104-108	154
745.109	154
745.110-114, 745.131	154
745.139, 745.142	154
745.143-145, 745.147-149	154
745.600-611, 745.613-614, 745.616, 745.620-625,	
745.630-639, 745.642-650, 745.653-657, 745.659-661,	
745.663, 745.666-689, 745.700-703, 745.730-733,	
745.736-742, 745.750-755, 745.774, 745.780-787,	
745.791, 745.799-800	154
745.810, 745.812, 745.820, 745.822, 745.824-827	154
745.880-881	154
748.210-211	154
748.214	155
748.216	155
748.218	155
748.230	155
748.234	155
748.236	155
748.238	155
748.400-401	155
748.402-403	155
748.430-433	155
748.434-436	156
748.437-439	156
748.440	156
748.441-445	156
748.446-448	156
748.449-451	156
748.452-454	156
748.455-459	156
748.460-462	156
748.463	157
748.464	157
748.465	157
748.466-468	157
748.469-470	157
748.471	157
748.590	157
748.900-901	157
748.902, 748.904-907	157
748.908	157
748.910	157
748.911	158
748.912	158
748.913-922, 748.925-930, 748.932-933, 748.936	158
748.990-999	158
749.000	158
749.001, 749.003-004	158
749.005	158
749.006	158
749.007	158
749.010	158
749.011	158
749.031-036	158
	159
749.100-101	159
749.102-103, 749.105-107	159

749.108	159
749.130-141	159
749.300-301	159
770.000-003	159

OPEL

MOVANO, 1.9 DTI	159
MOVANO	159
MOVANO, 2.8 DTI	159
MOVANO, 2.8 DTI	159
MOVANO	159
VIVARO	160

PEUGOET

Boxer 1.9 D, 1.9 TD, 2.0 HDI, 2.0 i	160
Boxer 1.9 D, 1.9 TD, 2.0HDI, 2.0 i	160
Boxer 1.9 D, 1.9 TD, 2.0 HDI, 2.0 i	160
Boxer 2.0, 2.0 Hdi, 2.2 Hdi	160
Boxer 2.5 D, 2.5 TD, 2.5 TDI, 2.8 HDI	160
Boxer 2.8 HDi	160
Boxer 4X4: 1.9 TD, 2.0 i, 2.5 D, 2.5 TD, 2.5 TDI	160
Boxer 4X4: 2.8 Hdi	161
Boxer 1.9 D, 1.9 TD, 2.0 HDI, 2.0 i	161
Boxer 1.9 D, 1.9 TD, 2.0HDI, 2.0 i	161
Boxer 2.0, 2.0 Hdi, 2.2 Hdi	161
Boxer 2.5 D, 2.5 TD, 2.5 TDI, 2.8 HDI	161
Boxer 2.8 HDI	161
Boxer 4X4: 1.9 TD, 2.0 i, 2.5 D, 2.5 TD, 2.5 TDI	161
J 5 1.8, 2.0	161
J 5	161
J 5 2.0, 2.5 D	161
J 5	161
J 5 4X4	161
J 5	162
J 5	162
J 5	162
J 5 1.8	162
J 5	162
J 5 1.8	162
J 5 1.9 D, 2.0, 2.5 TD	162
J 5 2.0, 2.5 D	162
J 5 4X4	162
J 7	162
J 9	162

RENAULT (RVI)

MASTER I	163
MASTER II	163
MASTER II	163
MASTER II, 2.5 D (ED0A, FD0A, HD0A, HD1A, JD0A, JD1A, UD0A, UD1A, UD4A)	163
MASTER II, 2.8 dTi (FD2B, JD0B, JD1B)	163
MASTER II, 2.8 dTi (FD0F, FD0R, FD3F, HD0F, HD1F, UD0F, UD1F, UD4F)	163
MASTER II, 1.9 dTi (FD0L, FD0P)	163
MASTER II, 1.9 dTi (JD0L, JD1L, JD1P)	163
MASTER II, 2.2 dCi 90 (FD0G, FD0N, FD2N, FD3G, FD3N)	163
MASTER II, 2.2 dCi 90 (JD0G, JD0N, JD1G, JD1N)	163
MASTER II, 2.2 dCi 90 (ED0G, ED0N, HD0G, HD0N, HD1G, HD1N, UD0G, UD0N, UD1G, UD1N, UD4G, UD4N)	164
MASTER II, 2.5 D (FD0A, FD0E, FD2E, FD3E)	164
MASTER II, 2.5 dCi 120 (FD0M, FD0U, FD0V, FD2M, FD3M, FD3U, FD3V, FD8M, FD8V)	164
MASTER II, 2.5 D (JD0A, JD0E, JD1A, JD1E)	164
MASTER II, 2.5 dCi 120 (JD0M, JD1M)	164



MASTER II, 2.5 D (ED0A, ED0E, HD0A, HD0E, HD1A, HD1E, UD0A, UD0E, UD1A, UD1E, UD4A, UD4E)	164	G 210	174
MASTER II, 2.5 dCi 120 (ED0M, ED0U, ED0V, ED8U, ED8V, HD0M, HD0U, HD0V, HD1M, HD1U, HD1V, UD0M, UD0V, UD1M, UD1U, UD1V, UD4M, UD4U, UD8V)	164	G 210 Manager	175
MASTER II, 2.8 dTi (FD0C, FD0F, FD0R, FD2B, FD2F, FD3C, FD3F)	164	G 220 BOM	175
MASTER II, 2.8 dTi (JD0B, JD0F, JD1B, JD1F)	164	G 230	176
MASTER II, 2.8 dTi (ED0C, ED0F, HD0C, HD1C, HD1F, UD0C, UD0F, UD1C, UD1F, UD4C, UD4F)	165	G 230 Incendie	176
MASTER II, 3.0 dCi 140 (FD0S, FD2T, FD3S)	165	G 230 TI	176
MASTER II, 3.0 dCi 140 (JD0T, JD1T)	165	G 235 Maxter 4x2	177
MASTER II, 3.0 dCi 140 (ED0S, ED8S, HD1S, UD0S, UD1S, UD4F, UD8S)	165	G 260 11/13 T	177
Trafic I	165	G 260 15 T	177
4x4: Trafic I	165	G 260 16/17 T	177
Trafic I	165	G 260 19 T	177
4x4: Trafic I	165	G 260 22 T	178
Trafic I	165	G 260 26 T	178
Trafic II	165	G 270 BOM	178
4x4: Trafic II	166	G 270 Incendie	178
Trafic II	166	G 270 Maxter 4x2	179
Trafic III	166	G 270/280 Manager 4x2, 6x2/4	179
Magnum 390/430/470/560	166	G 270/280 Manager 4x4	179
Magnum 400/440/480 E-TECH	166	G 270/280 Manager 6x2, 6x4, 8x4	180
Magnum E-TECH	166	G 290 (VTL) 6x4	180
110.130 6x6	167	G 290 16/17 T	180
110.150 4x4	167	G 290 19 T	181
110/150, 110/170 4x4	167	G 290 VTL	181
110.170 4x4	167	G 300 Maxter 4x2	181
130 B6/B6A	168	G 300 Maxter 6x4, 8x4	181
130 B9/B9A	168	G 300/330/340 TI Manager 4x2, 6x2/4	181
130 B11/B13/B14	168	G 300/330/340 TI Manager 4x4	182
150 B11/ B13	168	G 300/330/340 TI Manager 6x2, 6x4, 8x4	182
75.130 4x4	168	G 320-19 (VF6-BA)	183
770 KB6	169	G 320-19 T (VF6-BG)	183
85.150 4x4	169	G 340 TI 4x4 (VF6-BH02)	183
85/150 4x4	169	G 340 TI Maxter 4x2	183
90 B6/B6A/B6Z/B7	169	G 340 TI Maxter 6x4, 8x4	183
90 B8	170	G 340 TI Maxter 6x6	183
95.130 4x4	170	GB 131-HR15	183
B 110 (4x2)	170	GB 191	184
B 110 (4x4)	170	GB 231	184
B 120	170	GBC 180	184
B 70	170	GBH 260 (6x6)	184
B 80	171	GBH 260 (6x4)	184
B 90	171	GBH 280 E (6x6)	184
C 210	171	GBH 280 (6x4 D)	184
C 230/260/280/290 (4x2, 4x4)	171	GBH 280 (6x4)	184
C 300/340 TI (4x2, 4x4)	171	GBH 280 (6x6)	185
C 260/280/290 (6x4)	171	GC 191	185
C 300/340 TI (6x4)	172	GC 231	185
CBH 280/340/350/380 (6x4)	172	GF 191	185
CBH 280/340/350 (6x6)	172	GF 231	185
CBH 320/385 (6x4)	172	GLC 190	185
CBH 320/385 (6x6)	172	GLM 280	185
CE 160 Maroc	173	GLR 190/230	185
CLM 280/340/350/380	173	GLR 230 (4x4)	186
CLM 320/385 (4x2)	173	GR 191	186
CLR 220 (4x2)	173	GR 231	186
CLR 220 (4x4)	173	GR 280/350	186
CLR 230	173	GR 305	186
G 170-11/13/15	174	GRH 235	186
G 170-16/17	174	GRH 235 R	186
G 200	174	GRH 305 (6x4)	187
		GRH 350 6x4 GRH 350 TS	187
		JK 50/55/60/65/75	187
		JN 60/75/85/90/95	187
		JP 11	187
		JP 13 A/B/C	187
		JP 14 BOM	188
		JR 19/21	188





JX 21	188
KERAX	188
M 140/160	188
M 150/180	189
M 150/180 (VF6 40-ACA/ACC), M 180 (VF6 40-ACB/ACD)	189
M 150/180 (VF6 40-ACA/ACC), M 180 (VF6 40-ACB/ACD)	190
M 180/210	190
M 200/230	190
M 210/230 TI (VF6- 40)	190
M250	191
ME 160 (VF6-JE 13) 4x2	192
ME 160 (VF6-JE 13) 4x4	192
ME 160 (VF6-JE 13) 4x2, 4x4	192
ME 160/180 (VF6-JE 15) 4x2	192
PA 160/180 Maroc	192
PC 27 S	193
PP 160/180	193
Premium 260 SP	193
Premium 6x2, 6x2/4	193
Premium 6x2 Pusher FAB 22C	194
Premium 6x2 Pusher FAB 22A	194
Premium PR / TR 4x2	194
Midliner Grand Bretagne	194
Midlum (FAB 43E1-43E2)	195
Midlum (42B3/4-44T)	195
Midlum (FAB 42US-44US-45US)	195
Midlum (FAB 42B1/2-43C1/2-43T/V)	195
PS 130-09/150-09	195
PS 150 Carrier	195
PS 150/160	196
PX 28/28 T	196
PX 30 V/VT	196
PX 30/30 T	196
PX 40 V/VT/VTS	196
R 310/310 T 6x4	196
R 310/330/340/365	197
R 340 TI	197
R 350	197
R 360/360 T	198
R 360/360 T 6x4	198
R 370	198
R 370 (6x4)	198
R 370 T	198
R 380	199
R 385 TI	199
R 390	199
R 390 (6x4)	200
R 390 T	200
R 420	200
R 420 6x4	200
R 420 T	200
R 420 TI	200
R 6x4 TS	201
RI 357	201
S 90 - 09 (VF6 JN)	201
S 100 (VF6 JK)	202
S 110/130 (VF6 JK)	202
S 120/135 (VF6)	202
S 130 - 06/08/09 (VF6 JN)	202
S 130/150/170 (VF6 JP)	202
S 135/150 (VF6 AE)	203
S 140/160 (VF6)	203
S 150 - 06/08/09 (VF6 JN)	203
S 150 (VF6 JK-SC, VF6 JN-1E), S150/180 (VF6 40-ACF/ACE)	203
S 170 4x4	204
S 170/220 (VF6 JS)	204

S 90/130/150 (VF6 JN)	204
S 210	204
SE 160/180 Maroc	205
SG 2	205
SG 3	206
SG 4	206
TB 191	206
TB 231	206
TBH 260 (6x4)	206
TBH 280 E (6x6)	206
TBH 280 (6x4 D)	206
TBH 280 (6x4)	206
TBH 280 (6x6)	207
TR 280/350	207
TLM 280	207
TR 305	207
TRH 305 (6x4)	207
TRH 350 6x4 TRH 350 TS	207
TRM 2000	207
TRM 4000	208

SCANIA

L 80, LB 80	208
L 81, LB 81	208
LB 81	208
L 81, LB 81	208
G 82, P 82, P 82 M, P 82 H	208
G 82 H, P 82 H (6x2)	209
G 82 M, P 82 M (6x2)	209
G 82, P 82	209
T 82 M (4x2)	209
T 82 M (4x2), T 82 H (6x2)	209
T 82 M (4x2)	209
T 82 M (4x2), T82 H (4x2, 6x2)	209
T 82 M (4x2), T 82 H (4x2, 6x2)	210
T 82 H (6x2)	210
L 85, LS 85	210
LB 85, LBS 85	210
L 85, LS 85, LB 85, LBS 85	210
LS 85, LBS 85	210
L 86, LS 86	210
L 86, LS 86, LB 86, LBS 86	210
LS 86, LBS 86	210
G 92, P 92, P 92 M, P 92 H	211
G 92 H, P 92 H, R 92 H (6x2)	211
G 92 M, P 92 M (6x2)	211
G 92, P 92, P 92 M, P 92 H	211
G 92, P 92 (6x2, 6x4)	211
P 92 H (6x2)	212
G 93, P 93, R 93, P 93 M, P 93 H, T 93	212
94D, 94L, 94C, 94G	213
L 110, LS 110	214
LS 110	214
LT 110	214
LB 110, LBS 110	215
LBS 110	215
LBT 110	215
L 111, LS 111, LT 111	215
L 111, LT 111	215
L 111, LS 111, LT 111	215
LT 111	215
L 111, LS 111, LT 111	215
LS 111	215
LB 111, LBS 111, LBT 111	216
LBT 111 FB	216
LB 111, LBS 111, LBT 111 BB/FB	216



LB 111, LBT 111 BB	216
LB 111, LBS 111, LBT 111 BB	216
G 112 M, P 112 M, R 112 M, P 112 H, P 112 E, R 112 H, R 112 E	216
G 112, P 112, R 112	217
G 112 M, P 112 M, R 112 M	217
G 112, P 112, R 112	217
P 112 M (6x2), R 112 M (6x2)	217
P 112 H (6x2), R 112 H (6x2)	217
T 112 M (4x2), T 112 H, T 112 E	218
T 112 (4x2, 6x2, 6x4)	218
T 112 M (4x2)	218
T 112 (4x2, 6x2, 6x4)	218
T 112 (6x2)	218
P 113, R 113, T 113, P 113 H, P 113 E, R 113 H, P 113 M, R 113 M, K 113 E, R 113 M, T 113 H, T 113 E	219
P 113, R 113, T 113, P 113 H, P 113 E, R 113 H, P 113 M, R 113 M, K 113 E, R 113 M, T 113 H, T 113 E	219
114L, 114C, 114G	219
124L, 124C, 124G	221
L 140, LS 140, LT 145	223
L 140, LS 140	223
LS 140	223
LB 140, LBS 140, LBT 140	223
LB 140, LBS 140	223
LBS 140	223
L 141, LS 141, LT 146	224
L 141, LS 141	224
L 141, LS 141, LT 146	224
LS 141	224
LB 141, LBS 141, LBT 141	224
LBT 141 FB	224
LB 141, LBS 141, LBT 141 BB/FB	224
LBT 141 BB	224
LB 141, LBS 141, LBT 141 BB	225
LBS 141	225
R 142 M (4x2), R 142 H, R 142 E	225
R 142 (4x2, 6x2, 6x4)	225
R 142 M (6x4)	225
R 142 (4x2, 6x2, 6x4)	225
R 142 (6x2)	226
R 142 H (6x2)	226
R 142 M (6x2)	226
T 142	226
T 142 (4x2, 6x2, 6x4), T 142 E	226
T 142 M	226
T 142 (6x4)	227
T 142 (4x2, 6x2, 6x4)	227
T 142 (6x2)	227
R 143, R 143 E, R 143 H, R 143 M, T 143 H	227
R 143, T 143	227
R 143	227
R 143, T 143	227
144L, 144C, 144G	228
P, R serie	230

VOLKSWAGEN

LT 28, LT 31 (281-286)	230
LT 35 (291-296)	230
LT 28-46 II	231
LT 40, LT 45 (291, 293, 295)	231
LT 40, LT 45 (292, 294, 296)	231
LT 50, LT 55	231
Transporter II, 1.6	231
Transporter II, 1.7	231
Transporter II, 2.0	231

Transporter II, 1.6, 1.6 D, 1.6 TD, 1.7, 1.7 D	231
Transporter III, 1.6	231
Transporter III, 1.6 D, 1.6 TD, 1.9, 2.0	232
Transporter III, 1.6 D, 1.6 TD	232
Transporter III, 1.7 D	232
Transporter III, 1.9, 2.0	232
Transporter III, 2.1, 2.1 i	232
Syncro: Transporter III	232
Syncro: Transporter III, 1.9, 2.0, 2.1, 2.1 i	232
Transporter IV	232
Syncro: Transporter IV	232
Transporter IV	232
Syncro: Transporter IV	232
Transporter V	232
4Motion: Transporter V	232
Transporter V	232

VOLVO

F 84, F 85	232
N 84	233
F 86, F 87	233
F 86, FB 86, F 87	233
F 86, F 87	233
F 86, FB 86, F 87	233
FB 86	233
N 86, NB 86	233
N 86	233
N 86, NB 86	233
N 86	233
F 88, FB 88, G 88	233
FB 88, G 88 (6x2)	234
N 88 (4x2), NB 88 (6x2)	234
N 88, NB 88	234
NB 88 (6x2)	234
F 89, G 89 (4x2, 6x2, 6x4)	234
F 89, G 89 (4x2, 6x2)	234
F 89, G 89 (6x2)	234
F 406, F 407, F 408	234
FL 4	234
F 607, F 608, F 609, F 610	235
F 611	235
F 612, F 613	235
F 614	235
F 611, F 612, F 613, F 614	235
F 615, F 616, F 617	235
FL 6 (Ch B166080-, FL608-FL612)	235
FL 6 (Ch B166080-, FL612-FL615)	236
FL 6 (Ch B166080-, FL616-FL626)	236
FL 6 (Ch -B169139, FL616-FL626)	236
FL6 (Ch.B169140-, FL616-FL626)	236
FL 6 (Ch B 169140- B190331, 4x2, 6x2, 6x4)	236
FL 6 (Ch B166080-, FL618-FL619)	236
FL 6 (Ch B166080-, FL608-FL612)	236
FL 6 (Ch B166080-, FL612-FL615)	236
FL 6 (Ch B166080-, FL616-FL617)	236
FL 6 (Ch B166080-, FL616-FL626, 4x2)	236
FL 6 (Ch.-B169139, FL618-FL619, 4x2)	237
FL 6 (Ch B166080-)	237
FL 608-612	237
FL 608-611	237
FL 608-612	237
FL 608-615	237
FL 612	237
FL 612-614	237
FL 612-615	237





FL 612-614	237	N 12 (6x2)	248
FL 616-617	237	NH 12 (Ch.668771-)	248
FL 616-619	237	NL 12 S	249
FL 616-617	238	NL 12 S (4x2, 6x2, 6x4)	249
FL 618-619	238	F 16 (4x2, 6x2, 6x4)	249
FL 616-619	238	F 16 (4x2, 6x2)	249
F 7 (4x2, 6x2, 6x4, 8x2, 8x4)	238	F 16 (4x2, 6x2, 6x4)	249
F 7 (4X2, 6X2, 8X2, 6X4, 8X4)	238	F 16 (6x4)	249
F 7 (6X2, 6X4, 8X2, 8X4)	239	FH 16	250
F 7 (4X2)	239	FH 16 (4x2, 6x2, 6x4, 8x4)	250
F 7 (6x2)	239	FH 16 (4x2, 6x2, 6x4) Ch.-A291151	250
FL 7	239	FH 16 (4x2, 6x2, 6x4)	250
FL 7 (4x2, 6x2, 8x2, 6x4, 8x4)	239	FH 16 (4x2, 6x2, 6x4) Ch. -A276505, -B190367, -563621	250
FL 7 (4x2, 6x2, 6x4)	239	FH 16 (Ch. A291152-)	250
FL 7	239	FH 16 (4x2, 6x2, 6x4) Ch. -A276505, -B190367, -563621	251
FL 7 (4x2, 6x2, 6x4)	239	FH 16 CHID. -A291151	251
FL 7	240	FH 16 (4x2, 6x2, 6x4)	251
FL 7 (4x2, 6x2, 6x4)	240	FH 16 (4x2, 6x2, 6x4, 8x4)	251
FM7	240		
FS 7	240		
N 7 (4x2, 6x2, 6x4)	240		
N 7 (4x2, 6x2)	241		
N 7 (4x2, 6x2, 6x4)	241		
N 7 (4x2, 6x2)	241		
N 7 (6x2)	241		
FM 9	241		
F 10 (4x2, 6x2, 6x4)	241		
F 10 (4x2, 6x2)	241		
F 10 (4x2, 6x2, 6x4)	242		
F 10 (4x2, 6x2)	242		
F 10 (6x2)	242		
FL 10	242		
FL 10 (6X4, 8X4)	242		
FL 10 (4x2, 6x2, 6x4, 8x4)	243		
FL 10 (4x2, 6x2, 8x2, 6x4, 8x4)	243		
FL 10 (4x2, 6x2, 6x4)	243		
FL 10	243		
FL 10 (4x2, 6x2, 6x4)	243		
FL 10	243		
FL 10 (4x2, 6x2, 6x4)	243		
FM10	243		
FS 10	244		
FS 10 (4x2, 6x4, 8x4)	244		
N 10 (4x2, 6x2, 6x4)	244		
N 10 (4x2, 6x2)	244		
N 10 (4x2, 6x2, 6x4)	244		
N 10 (6x2)	245		
NL 10 S	245		
NL 10 S (4x2, 6x2, 6x4)	245		
F 12 (4x2, 6x2, 6x4)	245		
F 12 (4x2, 6x2, 6x4, 8x2, 8x4)	245		
F 12 (4x2, 6x2, 6x4)	245		
F 12 (4x2, 6x2, 6x4, 8x2, 8x4)	246		
F 12 (6x2)	246		
F 12 (6x2, 8x2)	246		
FH 12	246		
FH 12 (4x2, 6x2, 6x4, 8x4)	246		
FH 12 (4x2, 6x2, 6x4)	246		
FH 12	247		
FH 12 (4x2, 6x2, 6x4), Ch.-A276505, -B190367, -563621	247		
FH 12 (4x2, 6x2, 6x4)	247		
FL 12	247		
FL 12 (4x2, 6x2, 6x4, 8x4)	247		
FLC	247		
FM12	247		
N 12 (4x2, 6x2, 6x4)	248		



CITROËN

C 25	•		VKBA 844	•			1)
C 25, 1.8 E, 1.9 D, 2.0 E, 2.5 D Turbo	•		VKBA 1444	•			2)
C 25, 1.9 TD, 2.0	•		VKBA 1444	•			3)
4x4: C 25	•		VKBA 844	•			4)
	•		VKBA 1444	•			5)
C 25	○		VKBA 845	•			6)
	○		VKBA 846	•			7)
	○		VKBA 1462	•			8)
	○		VKBA 1463	•			9)
	○		VKBA 1445	•			10)
	○		VKBA 1446	•			11)
4x4: C 25	○		VKBA 1312	•			12)
Jumper, 1.9 D, 1.9 TD, 2.0, 2.0 HDi	•		VKBA 1444	•			13)
	•		VKBA 3428	•			14)
	•		VKBA 3640	•			15)
	•		VKBA 3641	•			16)
Jumper, 2.0, 2.0 bivalent, 2.0 HDi, 2.2 HDi	•		VKBA 3640	•			17)
	•		VKBA 3641	•			18)
Jumper, 2.5 TD, 2.5 TDi, 2.8 HDi	•		VKBA 1444	•			19)
	•		VKBA 3428	•			20)
	•		VKBA 3640	•			21)





CITROEN .../...

	•		VKBA 3641	•			22)
Jumper, 2.8 HdI	•		VKBA 3640	•			17)
	•		VKBA 3641	•			18)
Jumper, 4x4: 1.9 TD, 2.0, 2.5 D, 2.5 TD, 2.5 TDi, 2.8 HDi	•		VKBA 1444	•			23)
	•		VKBA 3428	•			24)
	•		VKBA 3640	•			25)
	•		VKBA 3641	•			26)
Jumper, 4x4: 2.8 HDi	•		VKBA 3640	•			17)
	•		VKBA 3641	•			18)
Jumper, 1.9 D, 1.9 TD, 2.0, 2.0 HDi	○		VKBA 3429	•			13)
	○		VKBA 3430	•			14)
	○		VKBA 3642	•			27)
Jumper, 2.0, 2.0 bivalent, 2.0 HDi, 2.2 HDi	○		VKBA 3642	•			
Jumper, 2.5 TD, 2.5 TDi, 2.8 HDi	○		VKBA 3429	•			19)
	○		VKBA 3430	•			20)
	○		VKBA 3642	•			27)
Jumper, 2.8 HDi	○		VKBA 3642	•			
Jumper, 4x4: 1.9 TD, 2.0, 2.5 D, 2.5 TD, 2.5 TDi, 2.8 HDi	○		VKBA 1444	•			28)
Jumper, 4x4:	○		VKBA 3679	•			29)



DAF

Sherpa 285, 300, 310, 350	●		VKBA 5240		● ●	VKHB 2237 VKHB 2238	L 68149/110/Q 07087 X/ K-07210 X		
		○			● ●	VKHB 2246 VKHB 2239	18790/18720/Q 18690/18620/Q		2), 22)
Sherpa 285, 310, 350 (MT 210)	●		VKBA 5240		● ●	VKHB 2237 VKHB 2238	L 68149/110/Q 07087 X/ K-07210 X		19), 21)
		○			● ●	VKHB 2246 VKHB 2239	18790/18720/Q 18690/18620/Q		2), 18)
F 400 Ser.	●	28 N	VKBA 5240		● ●	VKHB 2237 VKHB 2238	L 68149/110/Q 07087 X/ K-07210 X		
		○306			● ●	VKHB 2246 VKHB 2239	18790/18720/Q 18690/18620/Q		2)
F 600 Ser.	●	60 N			● ●	VKHB 2067 VKHB 2016	33209/Q 32206 J2/Q	VKS 6266	
		○ 512			●	VKHB 2034	3955/394A	VKS 6267	
F 800 Ser.	●	60 N			● ●	VKHB 2067 VKHB 2016	33209/Q 32206 J2/Q	VKS 6266	
		○ 512			●	VKHB 2034	3955/394A	VKS 6267	
F 1000 Ser.	●	84 N			● ●	VKHB 2241 VKHB 2242	45291/45220 3490/3420		
		○ 715			●	VKHB 2137	JM 714249/ 210/Q		
					●	VKHB 2243	JM 511946/JM 511910/Q		
F 1300 Ser.		○ 1835			●	VKHB 2140	33016/Q	VKS 6170	
F 1600 Ser.	●	N 142			● ●	VKHB 2132 VKHB 2070	331933/Q 32310 J2/Q		
		○ 1635			● ●	VKHB 2141 VKHB 2142	681 A/672 47687/47620/Q	VKS 6171 VKS 6170	3)
		○ 1635			●	VKHB 2083	CK-598 A/ K-592 A		4)
					●	VKHB 2142	47687/47620/Q	VKS 6170	
F 1700 Ser.	●	122 N			●	VKHB 2004	32309 J2/Q		





DAF .../...

		O924			●	VKHB 2140	33016/Q	
F 1900 Ser.	●	122 N			●	VKHB 2236	32309 BJ2/ QCL7C	
	●	131 N			●	VKHB 2236	32309 BJ2/ QCL7C	
	○	924			●	VKHB 2140	33016/Q	
F 2000/2005 Ser.	●	N 142			●	VKHB 2132	331933/Q	5)
	●	N 142			●	VKHB 2068	33210/Q	
	●	N 142			●	VKHB 2132	331933/Q	6)
	○	1635			●	VKHB 2070	32310 J2/Q	
	○	2255			●	VKHB 2141	681 A/672	VKS 6171
○	Trailing axle			●	VKHB 2142	47687/47620/Q	VKS 6170	
F 2100/2105 Ser.	●	N 142			●	VKHB 2141	681 A/672	VKS 6171
	●	N 142			●	VKHB 2043	663/653/Q	VKS 6170
	○	2255			●	VKHB 2141	681 A/672	VKS 6171
	○	Trailing axle			●	VKHB 2043	663/653/Q	VKS 6170
	○	Trailing axle			●	VKHB 2141	681 A/672	VKS 6171
F 2300/2305 Ser.	●	N 142			●	VKHB 2043	663/653/Q	VKS 6170
	●	N 142			●	VKHB 2132	331933/Q	5)
	●	N 142			●	VKHB 2068	33210/Q	
	○	2255			●	VKHB 2132	331933/Q	7)
	○	2699			●	VKHB 2070	32310 J2/Q	
F 2500/2503/2505 Ser.	●	N 142			●	VKHB 2132	331933/Q	8)
	○	2255			●	VKHB 2070	32310 J2/Q	
	○	Trailing axle			●	VKHB 2132	331933/Q	8)
	○	Trailing axle			●	VKHB 2070	32310 J2/Q	
	○	Trailing axle			●	VKHB 2141	681 A/672	VKS 6171
					●	VKHB 2043	663/653/Q	VKS 6170











	○ 2255				● VKHB 2141 ● VKHB 2043	681 A/672 663/653/Q	VKS 6171 VKS 6170	11)
	○ 2699		VKA 4216		● VKHB 2146 ● VKHB 2147	33021/QVB091 T2EE 100	VKS 6180	12)
	○ 2699				● VKHB 2143	687/672		13)
	○ Trailing axle				● VKHB 2141 ● VKHB 2043	681 A/672 663/653/Q	VKS 6171 VKS 6170	
F 2700 Ser.	● N 142				● VKHB 2132 ● VKHB 2070	331933/Q 32310 J2/Q		
	○ 1346				● VKHB 2145 ● VKHB 2082	33020/QVB091 33019/Q	VKS 6140	
F 2800 Ser.	● N 140				● VKHB 2132 ● VKHB 2068	331933/Q 33210/Q		14)
	● N 140				● VKHB 2132 ● VKHB 2068	331933/Q 33210/Q		15)
	● N 140				● VKHB 2132 ● VKHB 2070	331933/Q 32310 J2/Q		7)
	● N 140				● VKHB 2132 ● VKHB 2070	331933/Q 32310 J2/Q		8)
	● N 142				● VKHB 2132 ● VKHB 2070	331933/Q 32310 J2/Q		16)
	● N 142				● VKHB 2132 ● VKHB 2070	331933/Q 32310 J2/Q		17)
	○ 2255				● VKHB 2141 ● VKHB 2043	681 A/672 663/653/Q	VKS 6171 VKS 6170	
	○ 2699				● VKHB 2143	687/672		
	○ Trailing axle				● VKHB 2141 ● VKHB 2043	681 A/672 663/653/Q	VKS 6171 VKS 6170	
F 2900 Ser.	● N 142				● VKHB 2132 ● VKHB 2070	331933/Q 32310 J2/Q		16)
	● N 142				● VKHB 2132 ● VKHB 2070	331933/Q 32310 J2/Q		17)
	○ 1346				● VKHB 2145 ● VKHB 2082	33020/QVB091 33019/Q	VKS 6140	
	○ 1354		VKA 4216		● VKHB 2146 ● VKHB 2147	33021/QVB091 T2EE 100	VKS 6180	9)
	○ 1355		VKA 4216		● VKHB 2146 ● VKHB 2147	33021/QVB091 T2EE 100	VKS 6180	9)
F 3200 Ser.	● N 142				● VKHB 2132 ● VKHB 2070	331933/Q 32310 J2/Q		
	○ 1354		VKA 4216		● VKHB 2146 ● VKHB 2147	33021/QVB091 T2EE 100	VKS 6180	9)
	○ Trailing axle				● VKHB 2141 ● VKHB 2043	681 A/672 663/653/Q	VKS 6171 VKS 6170	
F 3300/3305 Ser.	● N 142				● VKHB 2132 ● VKHB 2070	331933/Q 32310 J2/Q		





DAF .../...

	○ 2699			●	VKHB 2143	687/672	
	○ Trailing axle			●	VKHB 2141 VKHB 2043	681 A/672 663/653/Q	VKS 6171 VKS 6170
F 3600 Ser.	● N 142			●	VKHB 2132 VKHB 2070	331933/Q 32310 J2/Q	
	○ 1346			●	VKHB 2145 VKHB 2082	33020/QVB091 33019/Q	VKS 6140
	○ 1355		VKA 4216	●	VKHB 2146 VKHB 2147	33021/QVB091 T2EE 100	VKS 6180
	○ 2699		VKA 4216	●	VKHB 2146 VKHB 2147	33021/QVB091 T2EE 100	VKS 6180
F 95 Ser.	● 132 N			●	VKHB 2236	32309 BJ2/ QCL7C	23)
	● 152 N	VKBA 5230		●	VKHB 2232 VKHB 2070	33216/QVB091 32310 J2/Q	VKS 6333 22)
	● 172 N		VKA 4214	●	VKHB 2231	T3FE 075/ QVB481	VKS 6333 22)
	○ 1346			●	VKHB 2002	32311 J2	
	○ 1354		VKA 4216	●	VKHB 2145 VKHB 2082	33020/QVB091 33019/Q	VKS 6140 23)
	○ 1355		VKA 4216	●	VKHB 2146 VKHB 2147	33021/QVB091 T2EE 100	VKS 6180 23),9)
	○ Trailing axle			●	VKHB 2146 VKHB 2147	33021/QVB091 T2EE 100	VKS 6180 23),9)
				●	VKHB 2141 VKHB 2043	681 A/672 663/653/Q	VKS 6171 23) VKS 6170
N 2800 Ser.	● N 142			●	VKHB 2132 VKHB 2070	331933/Q 32310 J2/Q	16)
	● N 142			●	VKHB 2132 VKHB 2070	331933/Q 32310 J2/Q	17)
	○ 2699			●	VKHB 2143	687/672	
LF 45	● F 36			●	VKHB 2241 VKHB 2242	45291/45220 3490/3420	
	○ SR 5.12			●	VKHB 2157	32016 X/Q	VKS 6357
LF 55	● F60			●	VKHB 2332	H 212749/ H 212710	VKS 6358
	○ SR 10.20			●	VKHB 2067	33209/Q	
				●	VKHB 2161 VKHB 2333	32019 X/Q 495/493	VKS 6140
65 CF	● N 150, 152			●	VKHB 2232 VKHB 2070	33216/QVB091 32310 J2/Q	VKS 6333 24)

								
	<ul style="list-style-type: none"> ● 172 N ● 182 N ○ AAS 1347 ○ AAS 1354, 1355 ○ Trailing axle 				<ul style="list-style-type: none"> ● VKHB 2231 ● VKHB 2002 ● VKHB 2232 ● VKHB 2070 ● VKHB 2145 ● VKHB 2082 ● VKHB 2146 ● VKHB 2147 ● VKHB 2141 ● VKHB 2043 	<ul style="list-style-type: none"> T3FE 075/ QVB481 33216/QVB091 32310 J2/Q 33020/QVB091 33019/Q 33021/QVB091 T2EE 100 681 A/672 663/653/Q 	<ul style="list-style-type: none"> VKS 6333 VKS 6333 VKS 6180 VKS 6180 VKS 6171 	<ul style="list-style-type: none"> 24) 24) 24) 24)
75 CF	<ul style="list-style-type: none"> ● N 150, 152 ● 172 N ○ AAS 1132 ○ AAS 1339 ○ AAS 1354, 1355 ○ Trailing axle 				<ul style="list-style-type: none"> ● VKHB 2232 ● VKHB 2070 ● VKHB 2231 ● VKHB 2002 ● VKHB 2145 ● VKHB 2082 ● VKHB 2145 ● VKHB 2082 ● VKHB 2146 ● VKHB 2147 ● VKHB 2141 ● VKHB 2043 	<ul style="list-style-type: none"> 33216/QVB091 32310 J2/Q T3FE 075/ QVB481 33020/QVB091 33019/Q 33020/QVB091 33019/Q 33021/QVB091 T2EE 100 681 A/672 663/653/Q 	<ul style="list-style-type: none"> VKS 6333 VKS 6333 VKS 6180 VKS 6180 VKS 6180 VKS 6171 	<ul style="list-style-type: none"> 24) 24) 24) 24) 24) 9)
85 CF	<ul style="list-style-type: none"> ● 172 N ● 182 N ○ AAS 1347 ○ AAS 1354, 1355 ○ Trailing axle 				<ul style="list-style-type: none"> ● VKHB 2231 ● VKHB 2002 ● VKHB 2232 ● VKHB 2070 ● VKHB 2145 ● VKHB 2082 ● VKHB 2146 ● VKHB 2147 ● VKHB 2141 ● VKHB 2043 	<ul style="list-style-type: none"> T3FE 075/ QVB481 33216/QVB091 32310 J2/Q 33020/QVB091 33019/Q 33021/QVB091 T2EE 100 681 A/672 663/653/Q 	<ul style="list-style-type: none"> VKS 6333 VKS 6333 VKS 6180 VKS 6180 VKS 6171 	<ul style="list-style-type: none"> 24) 24) 24) 24) 9)
95 XF	<ul style="list-style-type: none"> ● N 150, 152 ● 172 N ○ AAS 1347 ○ AAS 1354, 1355 ○ Trailing axle 				<ul style="list-style-type: none"> ● VKHB 2232 ● VKHB 2070 ● VKHB 2231 ● VKHB 2002 ● VKHB 2145 ● VKHB 2082 ● VKHB 2146 ● VKHB 2147 ● VKHB 2141 ● VKHB 2043 	<ul style="list-style-type: none"> 33216/QVB091 32310 J2/Q T3FE 075/ QVB481 33020/QVB091 33019/Q 33021/QVB091 T2EE 100 681 A/672 663/653/Q 	<ul style="list-style-type: none"> VKS 6333 VKS 6333 VKS 6180 VKS 6180 VKS 6171 	<ul style="list-style-type: none"> 24) 24) 24) 24) 9)
95 XF.530	<ul style="list-style-type: none"> ● 182 N ○ AAS 1347 				<ul style="list-style-type: none"> ● VKHB 2232 ● VKHB 2070 ● VKHB 2145 ● VKHB 2082 	<ul style="list-style-type: none"> 33216/QVB091 32310 J2/Q 33020/QVB091 33019/Q 	<ul style="list-style-type: none"> VKS 6333 VKS 6180 	<ul style="list-style-type: none"> 24) 24)















DAF .../...

- AAS 1354, 1355
- Trailing axle

- VKHB 2146 33021/QVB091 VKS 6180 24)
- VKHB 2147 T2EE 100
- VKHB 2141 681 A/672 VKS 6171
- VKHB 2043 663/653/Q

FIAT IVECO

242	●	VKBA 813	●			
Talento	●	VKBA 1444	●			36)
	○	VKBA 1445	●			37)
	○	VKBA 1446	●			38)
Ducato 13	●	VKBA 844	●			24)
	○	VKBA 845	●			20)
	○	VKBA 846	●			21)
	○	VKBA 1445	●			22)
	○	VKBA 1446	●			23)
Ducato I 10	●	VKBA 844	●			18)
	●	VKBA 1444	●			19)
	○	VKBA 845	●			20)
	○	VKBA 846	●			21)
	○	VKBA 1445	●			22)
	○	VKBA 1446	●			23)
Ducato I 14	●	VKBA 844	●			25)
	●	VKBA 1444	●			19)
	○	VKBA 1445	●			26)
	○	VKBA 1446	●			27)

										
Ducato I Maxi 18	•			VKBA 844		•				25)
	•			VKBA 1444		•				19)
		○		VKBA 1462		•				26)
		○		VKBA 1463		•				27)
Ducato II 10 4x2	•			VKBA 1444		•				83)
Ducato II 10 4x2		○		VKBA 3429		•				83)
Ducato II 10 4x4	•			VKBA 1444		•				84)
		○		VKBA 1444		•				84)
Ducato II 14 4x2	•			VKBA 1444		•				83)
		○		VKBA 3429		•				83)
Ducato II 14 4x4	•			VKBA 1444		•				84)
		○		VKBA 1444		•				84)
Ducato II 18 4x2	•			VKBA 3428		•				83)
		○		VKBA 3430		•				83)
Ducato II 18 4x4	•			VKBA 3428		•				84)
		○		VKBA 1444		•				84)
Ducato III JTD	•			VKBA 3640		•				100)
Ducato III 2.0, 2.0 Bipower, 2.3 JTD, 2.8 JTD	•			VKBA 3640		•				100), 102)
	•			VKBA 3641		•				100), 103)
Ducato III 4X4	•			VKBA 3640		•				101), 102)















FIAT IVECO

.../...

	●		VKBA 3641	●			101), 103)
Ducato III	○		VKBA 3642	●			100)
Daily 1 28-8	●		VKBA 1386	●			8)
	●		VKBA 1385	●			9)
	○	Salisbury 1	VKBA 821	●			10)
Daily 1 30-8	●	Iveco	VKBA 1386	●			60)
	●	Iveco	VKBA 1385	●			61)
	○	Iveco	VKBA 1393	●			62)
Daily 1 30-9	●	Iveco	VKBA 1386	●			63)
	●	Iveco	VKBA 1385	●			64)
	○	Salisbury 1	VKBA 821	●			13)
	○	Iveco	VKBA 1393	●			16)
Daily 1 32-8	●		VKBA 1386	●			8)
	●		VKBA 1385	●			9)
Daily 1 35-8	●	Iveco	VKBA 1386	●			67)
	●	Iveco	VKBA 1385	●			68)
	●		VKBA 1386	●			91)
	●		VKBA 1385	●			92)
	●		VKBA 3551	●			93)
	○	Salisbury 1	VKBA 821	●			69)
		Olveco	VKBA 1393	●			65)











									
	<input type="radio"/>	Iveco	VKBA 1394		•				66)
	<input type="radio"/>	Iveco	VKBA 1393		•				85),82)
	<input type="radio"/>	Iveco	VKBA 3552		•				86),82)
Daily 1 35-8 H. DUTY	<input checked="" type="radio"/>	Iveco	VKBA 1386		•				4)
	<input checked="" type="radio"/>	Iveco	VKBA 1385		•				5)
	<input type="radio"/>	Iveco	VKBA 1393		•				
Daily 1 35-9	<input checked="" type="radio"/>	Iveco	VKBA 1386		•				11)
	<input checked="" type="radio"/>	Iveco	VKBA 1385		•				12)
	<input type="radio"/>	Iveco	VKBA 1393		•				13)
	<input type="radio"/>	Salisbury 1	VKBA 821		•				13)
Daily 1 35-10	<input checked="" type="radio"/>		VKBA 1386		•				4)
	<input checked="" type="radio"/>		VKBA 1385		•				5)
	<input type="radio"/>		VKBA 1393		•				94)
	<input type="radio"/>		VKBA 1393		•				70), 95)
	<input type="radio"/>		VKBA 1394		•				71)
Daily 1 35-10 Turbodayly	<input checked="" type="radio"/>		VKBA 3551		•				96)
	<input type="radio"/>		VKBA 1393		•				85), 96)
	<input type="radio"/>		VKBA 3552		•				86), 96)
Daily 1 35-12 Turbodayly	<input checked="" type="radio"/>		VKBA 3509		•				72)
	<input checked="" type="radio"/>		VKBA 3508		•				73)
	<input checked="" type="radio"/>		VKBA 3551		•				82), 97)
	<input type="radio"/>		VKBA 1393		•				81)
	<input type="radio"/>		VKBA 1393		•				85),82), 97)





FIAT IVECO .../...

	<input type="radio"/>		VKBA 3552		• •		86),82), 97)
Daily 1 40-8	•	Iveco	VKBA 1386		•		67)
	•	Iveco	VKBA 1385		•		68)
	<input type="radio"/>	Salisbury 1	VKBA 821		•		13)
	<input type="radio"/>	Iveco	VKBA 1393		•		74)
Daily 1 40-8 H. DUTY	•		VKBA 1386		•		4)
	•		VKBA 1385		•		5)
	<input type="radio"/>		VKBA 1393		•		
Daily 1 45-10	•		VKBA 3509		•		4)
	•		VKBA 3508		•		5)
	<input type="radio"/>		VKBA 1393		•		75)
	<input type="radio"/>		VKBA 1394		•		76)
Daily 1 49-10	•		VKBA 3509		•		4)
	•		VKBA 3508		•		5)
	<input type="radio"/>		VKBA 1393		•		77)
	<input type="radio"/>		VKBA 1394		•		39)
Daily 1 49-10 Turbodayly	•		VKBA 3551		•		96)
	<input type="radio"/>		VKBA 3552		•		96)
Daily 1 49-12 Turbodayly	•		VKBA 3508		•		73)
	•		VKBA 3509		•		72)
	•		VKBA 3551		•		82), 97)
	<input type="radio"/>		VKBA 1394		•		74)











										
		○		VKBA 3552		•				82), 97
Daily 1 59-12 Turbodayly	•			VKBA 3553		•				97)
		○		VKBA 5274		•	VKHB 2209	BT1B 329138/ 34478/2/ QVQ276	VKS 6326	97)
						•	VKHB 2209	BT1B 329138/ 34478/2/ QVQ276		
Daily II 29L10	•			VKBA 3662		•				98)
		○		VKBA 3664		•				98)
Daily II 29L12	•			VKBA 3662		•				98)
		○		VKBA 3664		•				98)
Daily II 35C9	•			VKBA 3551		•				98)
		○		VKBA 3552		•				98)
Daily II 35C10	•			VKBA 3551		•				98)
		○		VKBA 3552		•				98)
Daily II 35C11	•			VKBA 3551		•				98)
		○		VKBA 3552		•				98)
Daily II 35C12	•			VKBA 3551		•				98)
		○		VKBA 3552		•				98)
Daily II 35C13	•			VKBA 3551		•				98)
		○		VKBA 3552		•				98)
Daily II 35C15	•			VKBA 3551		•				98)
		○		VKBA 3552		•				98)





FIAT IVECO .../...

Daily II 35S9	●	VKBA 3662	●	98)
	○	VKBA 3664	●	98)
Daily II 35S10	●	VKBA 3662	●	98)
	○	VKBA 3664	●	98)
Daily II 35S11	●	VKBA 3662	●	98)
	○	VKBA 3664	●	98)
Daily II 35S12	●	VKBA 3662	●	98)
	○	VKBA 3664	●	98)
Daily II 35S13	●	VKBA 3662	●	98)
	○	VKBA 3664	●	98)
Daily II 35S13 Bus	●	VKBA 3662	●	98)
	○	VKBA 3664	●	98)
Daily II 35S15	●	VKBA 3662	●	98)
	○	VKBA 3664	●	98)
Daily II 40C13 Bus	●	VKBA 3551	●	98)
	○	VKBA 3552	●	98)
Daily II 40C15 Bus	●	VKBA 3551	●	98)
	○	VKBA 3552	●	98)
Daily II 50C11	●	VKBA 3551	●	98)











										
		○		VKBA 3552		•				98)
Daily II 50C11 Bus	•			VKBA 3551		•				98)
		○		VKBA 3552		•				98)
Daily II 50C13	•			VKBA 3551		•				98)
		○		VKBA 3552		•				98)
Daily II 50C13 Bus	•			VKBA 3551		•				98)
		○		VKBA 3552		•				98)
Daily II 50C15	•			VKBA 3551		•				98)
		○		VKBA 3552		•				98)
Daily II 50C15 Bus	•			VKBA 3551		•				98)
		○		VKBA 3552		•				98)
Daily II 65C11	•			VKBA 3563		•				98)
		○		VKBA 3574		•				98)
Daily II 65C13	•			VKBA 3563		•				98)
		○		VKBA 3574		•				98)
Daily II 65C15	•			VKBA 3563		•				98)
		○		VKBA 3574		•				98)
Grinta: 28-8	•			VKBA 1386		•				8)
	•			VKBA 1385		•				9)
	○	Salisbury 1		VKBA 821		•				10)





FIAT IVECO .../...

Grinta: 30-8	●		VKBA 1386	●	8)
	●		VKBA 1385	●	9)
	●	Iveco	VKBA 1386	●	11)
	●	Iveco	VKBA 1385	●	12)
	○	Iveco	VKBA 1393	●	99)
Grinta: 30-9	●	Iveco	VKBA 1386	●	11)
	●	Iveco	VKBA 1385	●	12)
	○	Salisbury 1	VKBA 821	●	13)
Grinta: 32-8	●		VKBA 1386	●	8)
	●		VKBA 1385	●	9)
Grinta: 35-8	●		VKBA 1386	●	8)
	●		VKBA 1385	●	9)
	●	Iveco	VKBA 1386	●	11)
	●	Iveco	VKBA 1385	●	12)
	○	Salisbury 1	VKBA 821	●	10)
	○	Salisbury 1	VKBA 821	●	13)
Grinta: 35-9	●	Iveco	VKBA 1386	●	11)
	●	Iveco	VKBA 1385	●	12)
	○	Iveco	VKBA 1393	●	13)
	○	Salisbury 1	VKBA 821	●	13)
Grinta: 40-8	●		VKBA 1386	●	8)
	●		VKBA 1385	●	9)
	●	Iveco	VKBA 1386	●	11)









									
	<ul style="list-style-type: none"> ● Iveco ○ Salisbury 1 		<ul style="list-style-type: none"> VKBA 1385 VKBA 821 		<ul style="list-style-type: none"> ● ● ● 				<ul style="list-style-type: none"> 12) 13)
Grinta Ser S: 30-9, 35-8, 35-10, 40-8, 40-10	<ul style="list-style-type: none"> ● Iveco ● Iveco ○ Iveco 		<ul style="list-style-type: none"> VKBA 1386 VKBA 1385 VKBA 1393 		<ul style="list-style-type: none"> ● ● ● ● 				<ul style="list-style-type: none"> 14) 15) 16)
Grinta Ser S Turbo: 45-10, 16710	<ul style="list-style-type: none"> ● ● ○ Iveco 4512 		<ul style="list-style-type: none"> VKBA 3509 VKBA 3508 VKBA 1394 		<ul style="list-style-type: none"> ● ● ● ● 				<ul style="list-style-type: none"> 78) 79) 17)
100E15, 100E18, 100E21 Eurocargo	<ul style="list-style-type: none"> ● Iveco 5833 ○ Iveco 4517 ○ Iveco 4521 ○ Rockwell, F120-F125 		<ul style="list-style-type: none"> VKBA 5274 		<ul style="list-style-type: none"> ● ● ● ● ● ● 	<ul style="list-style-type: none"> VKHB 2249 R 33209/ QCLNVB323/ L 33209/ QCLNVQ276 VKHB 2250 JXC25370CA- 90KA2 VKHB 2209 BT1B 329138/ 34478/2/ QVQ276 VKHB 2209 BT1B 329138/ 34478/2/ QVQ276 VKHB 2253 JXC 25716 C/ JXC 25716 D VKHB 2253 JXC 25716 C/ JXC 25716 D VKHB 2208 567/563 	<ul style="list-style-type: none"> VKS 6316 VKS 6326 VKS 6326 	<ul style="list-style-type: none"> 31) 	
100E17, 100E18, 100E21 TECTOR, RE-STYLING EUROFIRE TECTOR E.FIRE RESTYLING	<ul style="list-style-type: none"> ● ○ 				<ul style="list-style-type: none"> ● ● ● 	<ul style="list-style-type: none"> VKHB 2249 R 33209/ QCLNVB323/ L 33209/ QCLNVQ276 VKHB 2250 JXC25370CA- 90KA2 VKHB 2253 JXC 25716 C/ JXC 25716 D VKHB 2253 JXC 25716 C/ JXC 25716 D 	<ul style="list-style-type: none"> VKS 6326 		
109-14, 109-14 CKD,	<ul style="list-style-type: none"> ● ● Iveco 5830 				<ul style="list-style-type: none"> ● ● ● 	<ul style="list-style-type: none"> VKHB 2255 T2ED 050/Q VKHB 2182 33207/Q VKHB 2201 30309 J2/Q VKHB 2202 30307 J2/Q 		<ul style="list-style-type: none"> 33) 	





FIAT IVECO .../...

	<ul style="list-style-type: none"> ○ Rockwell, H 140 E 		<ul style="list-style-type: none"> ● VKHB 2211 ● VKHB 2137 	<p>R 32217 J2/ VB128/ L 32217/Q JM 714249/ 210/Q</p>	VKS 6211	34)
109-14 Zeta	<ul style="list-style-type: none"> ● ○ Rockwell, H 140 E 		<ul style="list-style-type: none"> ● VKHB 2201 ● VKHB 2202 ● VKHB 2211 ● VKHB 2137 	<p>30309 J2/Q 30307 J2/Q R 32217 J2/ VB128/ L 32217/Q JM 714249/ 210/Q</p>	VKS 6211	39)
110-13A	<ul style="list-style-type: none"> ● ○ 		<ul style="list-style-type: none"> ● VKHB 2019 ● VKHB 2020 ● VKHB 2204 ● VKHB 2033 	<p>32211 J2/Q 32208 J2/Q 30216 J2/Q 32215 J2/Q</p>	VKS 6239	
110-16 A, 110-16 AH	<ul style="list-style-type: none"> ● Iveco VA 43 ○ Iveco 4540 		<ul style="list-style-type: none"> ● VKHB 2019 ● VKHB 2020 ● VKHB 2204 ● VKHB 2033 	<p>32211 J2/Q 32208 J2/Q 30216 J2/Q 32215 J2/Q</p>	VKS 6239	
115-14 (I-II-Serie), 115-17 (I-II-Serie), 115-17 H (I-II-Serie)	<ul style="list-style-type: none"> ● Iveco 5844 M ○ Rockwell, H 140 E 		<ul style="list-style-type: none"> ● VKHB 2173 ● VKHB 2061 ● VKHB 2211 ● VKHB 2137 	<p>33212/Q 33211/Q R 32217 J2/ VB128/ L 32217/Q JM 714249/ 210/Q</p>	VKS 6221 VKS 6211	
115-17 (II-Serie)	<ul style="list-style-type: none"> ○ Rockwell, H125-P130 		<ul style="list-style-type: none"> ● VKHB 2211 ● VKHB 2137 	<p>R 32217 J2/ VB128/ L 32217/Q JM 714249/ 210/Q</p>	VKS 6211	
120-13 (II-Serie), 120-14 (II-Serie)	<ul style="list-style-type: none"> ● Iveco 5850 ○ Iveco 4528/2 		<ul style="list-style-type: none"> ● VKHB 2003 ● VKHB 2198 ● VKHB 2080 	<p>32312 J2/Q 30311 J2/Q 32217 J2/Q</p>	VKS 6211	
120-17ANW	<ul style="list-style-type: none"> ● ○ 		<ul style="list-style-type: none"> ● VKHB 2204 ● VKHB 2168 ● VKHB 2248 ● VKHB 2215 	<p>30216 J2/Q 30215 J2/Q 30218 J2 30221 J2</p>		











								
120E15 EURO CARGO	●	○ Rockwell, H125-P130				● VKHB 2339 R 33211/ QCLNVB324/ L 33211/ QCLNVQ276 ● VKHB 2339 R 33211/ QCLNVB324/ L 33211/ QCLNVQ276 ● VKHB 2211 R 32217 J2/ VB128/ L 32217/Q ● VKHB 2137 JM 714249/ 210/Q		VKS 6330
120E21H EURO CARGO	●	○				● VKHB 2339 R 33211/ QCLNVB324/ L 33211/ QCLNVQ276 ● VKHB 2339 R 33211/ QCLNVB324/ L 33211/ QCLNVQ276 ● VKHB 2211 R 32217 J2/ VB128/ L 32217/Q ● VKHB 2137 JM 714249/ 210/Q		VKS 6330
130-13 A, 130-13 AH, 130-16 A, 130-16 AH	●	○ Iveco VA 43				● VKHB 2019 32211 J2/Q ● VKHB 2020 32208 J2/Q ● VKHB 2204 30216 J2/Q ● VKHB 2033 32215 J2/Q		VKS 6239
130-M7 FAL CKD	●	○ Iveco 5918, (AVA 36) ○ Iveco 7899, (HA 72)				● VKHB 2200 47487/47420 ● VKHB 2169 32017 X/Q ● VKHB 2200 47487/47420 ● VKHB 2169 32017 X/Q		
130E15, 130E18, 130E23 Eurocargo		○ Rockwell, H125-P130				● VKHB 2211 R 32217 J2/ VB128/ L 32217/Q ● VKHB 2137 JM 714249/ 210/Q		VKS 6330
130E18, 130E21, 130E24, 130E28 TEC- TOR, RESTYLING 130E24 EUROFIRE TECTOR, E.FIRE RESTYLING	●					● VKHB 2339 R 33211/ QCLNVB324/ L 33211/ QCLNVQ276		



FIAT IVECO

.../...

					●	VKHB 2339	R 33211/ QCLNVB324/ L33211/ QCLNVQ276		
130E18, 130E24.130E28 TECTOR	○				●	VKHB 2211	R 32217 J2/ VB128/ L 32217/Q JM 714249/ 210/Q		
130E21, 130E24, 130E28 TECTOR RE- STYLING 130E24 E.FIRE RETYLING	○		VKBA 5409		●				
135-14 H, 135-14 (H) CKD, 135-14 H CKD, 135-17 (H), 135-17 T, 135-17 H, 135-17 (H0 CKD), 135-17 H CKD	●	Iveco 5844 M			●	VKHB 2173	33212/Q	VKS 6221	34)
	○	Rockwell, H 140 E			●	VKHB 2061	33211/Q		
					●	VKHB 2211	R 32217 J2/ VB128/ L 32217/Q JM 714249/ 210/Q		34)
					●	VKHB 2137	JM 714249/ 210/Q	VKS 6211	
135-17 (I-Serie), 135-17 (II-Serie), A 135-17 (II-Serie)	●	Iveco 5844 M			●	VKHB 2173	33212/Q	VKS 6221	
	○	Rockwell, H 140 E			●	VKHB 2061	33211/Q		
					●	VKHB 2211	R 32217 J2/ VB128 /L 32217/Q JM 714249/ 210/Q	VKS 6211	
135E18 (4x4), 135E23 (4x4) Eurocargo	●				●	VKHB 2082	33019/Q		
	○				●	VKHB 2160	32021 X/Q		
					●	VKHB 2248	30218 J2		
					●	VKHB 2215	30221 J2		
135E21 EUROARGO 135E22W EUROFIRE 135E24W EUROFIRE	●				●	VKHB 2082	33019/Q		
	○				●	VKHB 2160	32021 X/Q		
					●	VKHB 2248	30218 J2		
					●	VKHB 2215	30221 J2		
140-14 (II-Serie), 140-20 (II-Serie)	●	Iveco 5850			●	VKHB 2003	32312 J2/Q		
	○	Iveco 4542			●	VKHB 2198	30311 J2/Q		
					●	VKHB 2031	32219 J2		
					●	VKHB 2080	32217 J2/Q		
140E18, 140E24 TECTOR RETYLING 140E24 EUROFIRE TECTOR 140E28 EUROFIRE TECTOR 140E28 E.FIRE RETYLING	●				●	VKHB 2082	33019/Q		
	○				●	VKHB 2160	32021 X/Q		
					●	VKHB 2248	30218 J2		
					●	VKHB 2215	30221 J2		

									
145-17 (II-Serie)	<ul style="list-style-type: none"> ● Iveco 5844 M ○ Rockwell, S 180 E 				<ul style="list-style-type: none"> ● VKHB 2173 ● VKHB 2061 ● VKHB 2210 ● VKHB 2211 	33212/Q 33211/Q 32219 J2/ VB129 R 32217 J2/ VB128/ L 32217/Q	VKS 6221		
150-14 (II-Serie), 150-16 A (II-Serie), 150-17 (I-Serie), 150-17 (II-Serie)	<ul style="list-style-type: none"> ● Iveco 5850 ○ Iveco 4542 				<ul style="list-style-type: none"> ● VKHB 2003 ● VKHB 2198 ● VKHB 2031 ● VKHB 2080 	32312 J2/Q 30311 J2/Q 32219 J2 32217 J2/Q			
150E18, 150E21, 150E24, 150E28 TECTOR, TECTOR RETYLING	<ul style="list-style-type: none"> ● 				<ul style="list-style-type: none"> ● VKHB 2339 ● VKHB 2339 	R 33211/ QCLNVB324/ L 33211/ QCLNVQ276 R 33211/ QCLNVB324/ L 33211/ QCLNVQ276			
150E18 TECTOR	<ul style="list-style-type: none"> ○ 				<ul style="list-style-type: none"> ● VKHB 2210 ● VKHB 2211 	32219 J2/ VB129 R 32217 J2/ VB128/ L 32217/Q			
150E21, 150E24, 150E28 TECTOR RETYLING	<ul style="list-style-type: none"> ○ 		VKBA 5409		<ul style="list-style-type: none"> ● ● 				
150E24, 150E27, 150E28 EUROFIRE, EUROFIRE TECTOR, E.FIRE RESTYLING	<ul style="list-style-type: none"> ● ○ 				<ul style="list-style-type: none"> ● VKHB 2339 ● VKHB 2339 ● VKHB 2210 ● VKHB 2211 	R 33211/ QCLNVB324/ L 33211/ QCLNVQ276 R 33211/ QCLNVB324/ L 33211/ QCLNVQ276 32219 J2/ VB129 R 32217 J2/ VB128/ L 32217/Q			
150E28 E.FIRE RESTYL- ING	<ul style="list-style-type: none"> ○ 		VKBA 5409		<ul style="list-style-type: none"> ● ● 				
150E15, 150E18, 150E23, 150E27 Euro- cargo	<ul style="list-style-type: none"> ○ Rockwell, R130-S180 				<ul style="list-style-type: none"> ● VKHB 2210 ● VKHB 2211 	32219 J2/ VB129 R 32217 J2/ VB128/ L 32217/Q			





FIAT IVECO

.../...

150E15 H, 150E18 H,
150E21 H, 150E23 H
Eurocargo

●

VKBA 5343

●

VKHB 2024

T2ED 070/
QCLNVB061
R 33114/
QCLNVQ276/
L 33114/
QCLNVQ276

VKS 6326

●

VKHB 2252

○

●

VKHB 2248

30218 J2

●

VKHB 2215

30221 J2

159-17 (I-Serie), 159-17
B (II-Serie), 159-20
(I-Serie)

●

Iveco 5860

●

VKHB 2013

6386/K-6320/Q
32310 TN9

VKS 6215

●

VKHB 2303

○

Iveco 4542

●

VKHB 2031

32219 J2

●

VKHB 2080

32217 J2/Q

160-16 A (II-Serie)

●

Iveco 5860

●

VKHB 2013

6386/K-6320/Q
32310 TN9

VKS 6215

●

VKHB 2303

○

Iveco 4542

●

VKHB 2031

32219 J2

●

VKHB 2080

32217 J2/Q

160-17-AN-ANW

●

●

VKHB 2082

33019/Q

VKS 6214

89)

●

VKHB 2334

30217 J2/Q

●

●

VKHB 2002

32311 J2

90)

●

VKHB 2001

32308 J2/Q

○

●

VKHB 2248

30218 J2

●

VKHB 2215

30221 J2

160-23 AH

●

Iveco 5875

●

VKHB 2203

JH415647-
99401

VKS 6216

●

VKHB 2002

32311 J2

○

Iveco 4590

VKA 4171

●

VKHB 2215

30221 J2

VKS 6218

●

VKHB 2216

32024 X

VKS 6225

160-23 ANW (4x4),
160-23 AHW (4x4)

●

Iveco 5965,
Iveco 5975

●

VKHB 2082

33019/Q

VKS 6214

●

VKHB 2160

32021 X/Q

○

Iveco 4590

VKA 4171

●

VKHB 2215

30221 J2

VKS 6218

●

VKHB 2216

32024 X

VKS 6225

160-26

●

Iveco 5865

●

VKHB 2013

6386/K-6320/Q
32310 TN9

VKS 6215

●

VKHB 2303

○

Iveco 4560

●

VKHB 2212

32221 J2

160-30 AHW

●

Iveco 5965,
Iveco 5975

●

VKHB 2082

33019/Q

VKS 6214

●

VKHB 2160

32021 X/Q

○

Iveco 4590

VKA 4171

●

VKHB 2215

30221 J2

VKS 6218

●

VKHB 2216

32024 X

VKS 6225

165-24 (II-Serie)

●

Iveco 5860

●

VKHB 2013











6386/K-6320/Q

VKS 6215

●

VKHB 2303

32310 TN9











									
	○ Iveco 4542					● VKHB 2031 ● VKHB 2080	32219 J2 32217 J2/Q		
170E15, 170E18, 170E23, 170E27 Euro- cargo	● ○		VKBA 5343			● VKHB 2024 ● VKHB 2252 ● VKHB 2210 ● VKHB 2211	T2ED 070/ QCLNVB061 R 33114/ QCLNVQ276/ L 33114/ QCLNVQ276 32219 J2/ VB129 R 32217 J2/ VB128/ L 32217/Q	VKS 6326	
170-23AH-AHW	● ● ○					● VKHB 2203 ● VKHB 2002 ● VKHB 2082 ● VKHB 2160 ● VKHB 2215 ● VKHB 2216	JH415647- 99401 32311 J2 33019/Q 32021 X/Q 30221 J2 32024 X	VKS 6216 VKS 6214 VKS 6225	90) 89)
170-25-AH-AHW	● ● ○					● VKHB 2203 ● VKHB 2002 ● VKHB 2082 ● VKHB 2160 ● VKHB 2215 ● VKHB 2216	JH415647- 99401 32311 J2 33019/Q 32021 X/Q 30221 J2 32024 X	VKS 6216 VKS 6214 VKS 6225	90) 89)
170-34AH-AHW	● ● ○					● VKHB 2203 ● VKHB 2002 ● VKHB 2082 ● VKHB 2160 ● VKHB 2215 ● VKHB 2216	JH415647- 99401 32311 J2 33019/Q 32021 X/Q 30221 J2 32024 X	VKS 6216 VKS 6214 VKS 6225	90) 89)
170/190-20, 170/ 190-26, 170/190-35	● Iveco 5865 ○ Iveco 4590			VKA 4171		● VKHB 2013 ● VKHB 2303 ● VKHB 2215 ● VKHB 2216	6386/K-6320/Q 32310 TN9 30221 J2 32024 X	VKS 6215 VKS 6218 VKS 6225	
175-17	● ○					● VKHB 2013 ● VKHB 2070 ● VKHB 2210 ● VKHB 2211	6386/K-6320/Q 32310 J2/Q 32219 J2/ VB129 R 32217 J2/ VB128/ L 32217/Q	VKS 6215	
175-24	●					● VKHB 2013 ● VKHB 2070	6386/K-6320/Q 32310 J2/Q	VKS 6215	





FIAT IVECO .../...

	○			●	VKHB 2210	32219 J2/ VB129	
	○			●	VKHB 2211	R 32217 J2/ VB128/ L 32217/Q	
				●	VKHB 2215	30221 J2	VKS 6225
				●	VKHB 2216	32024 X	
180E21 Eurocargo	●	Iveco 5833		●	VKHB 2249	R 33209/ QCLNVB323/ L 33209/ QCLNVQ276	VKS 6316
	○	Iveco 4521		●	VKHB 2250	JXC25370CA- 90KA2	
				●	VKHB 2253	JXC 25716 C/ JXC 25716 D	VKS 6326
				●	VKHB 2253	JXC 25716 C/ JXC 25716 D	
180E24, 180E27, 180E30, 180E34 iMPi, 180E34 iMTi Eurotech	●		VKBA 5343	●	VKHB 2024	T2ED 070/ QCLNVB061	VKS 6326
	○			●	VKHB 2252	R 33114/ QCLNVQ276/ L 33114/ QCLNVQ276	
				●	VKHB 2210	32219 J2/ VB129	
				●	VKHB 2211	R 32217 J2/ VB128/ L 32217/Q	
180E25 (4x4) Euro- trækker	●			●	VKHB 2082	33019/Q	
	○			●	VKHB 2160	32021 X/Q	
				●	VKHB 2215	30221 J2	
				●	VKHB 2216	32024 X	
180E27	●			●	VKHB 2251		VKS 6326
	○			●	VKHB 2251		
				●	VKHB 2210	32219 J2/ VB129	
				●	VKHB 2211	R 32217 J2/ VB128/ L 32217/Q	
180E38 Eurostar	●		VKBA 5343	●	VKHB 2024	T2ED 070/ QCLNVB061	VKS 6326
	○			●	VKHB 2252	R 33114/ QCLNVQ276/ L 33114/ QCLNVQ276	
				●	VKHB 2210	32219 J2/ VB129	
				●	VKHB 2211	R 32217 J2/ VB128/ L 32217/Q	











									
180E38 Eurotech	●	○	VKBA 5343			<ul style="list-style-type: none"> ● VKHB 2024 ● VKHB 2252 ● VKHB 2210 ● VKHB 2211 	T2ED 070/ QCLNVB061 R 33114/ QCLNVQ276/ L 33114/ QCLNVQ276 32219 J2/ VB129 R 32217 J2/ VB128/ L 32217/Q	VKS 6326	51)
180E42 Eurotech	●	○	VKBA 5343			<ul style="list-style-type: none"> ● VKHB 2024 ● VKHB 2252 ● VKHB 2210 ● VKHB 2211 	T2ED 070/ QCLNVB061 R 33114/ QCLNVQ276/ L 33114/ QCLNVQ276 32219 J2/ VB129 R 32217 J2/ VB128/ L 32217/Q	VKS 6326	
180E21, 180E24, 180E28 TECTOR RESTYL.	●	○	VKBA 5397			<ul style="list-style-type: none"> ● VKHB 2024 ● VKHB 2024 ● ● 	T2ED 070/ QCLNVB061 T2ED 070/ QCLNVB061		
180E21, 180E24, 180E28 TECTOR	●	○				<ul style="list-style-type: none"> ● VKHB 2024 ● VKHB 2024 ● VKHB 2211 ● VKHB 2210 	T2ED 070/ QCLNVB061 T2ED 070/ QCLNVB061 R 32217 J2/ VB128/ L 32217/Q 32219 J2/ VB129	VKS 6326	
190-24 Turbotech	●	○		VKA 4169		<ul style="list-style-type: none"> ● VKHB 2203 ● VKHB 2002 ● VKHB 2212 ● VKHB 2211 	JH415647-994 01 32311 J2 32221 J2 R 32217 J2/ VB128/L 32217/Q	VKS 6216 VKS 6218 VKS 6225	
190-24 T.R.U. (-06/88), 190-30 T.R.U. (-01/85), 190-30 G.V. (-06/88), 190-36 T-Range UNIF (-04/87), 190-38 (-01/85), 190-38 T.R.U. (-01/85)	●	○	Iveco 5875 Rockwell, U 180 E	VKA 4169		<ul style="list-style-type: none"> ● VKHB 2203 ● VKHB 2002 ● VKHB 2212 ● VKHB 2211 	JH415647- 99401 32311 J2 32221 J2 R 32217 J2/ VB128/ L 32217/Q	VKS 6216 VKS 6218 VKS 6225	





FIAT IVECO .../...

<p>190-24, 190-26 Turbotech, 190-30, 190-32 Turbotech, 190-36/38 Turbotech, 190-32 Turbotech G.V., 190-36 Turbotech G.V., 190-36/38 Turbostar, 190-42/48 Turbostar</p>	<ul style="list-style-type: none"> ● ○ 	<p>Iveco 5875</p> <p>Rockwell, řUř Series</p>	<p>VKA 4169</p>	<ul style="list-style-type: none"> ● ● ● 	<p>VKHB 2203</p> <p>VKHB 2002</p> <p>VKHB 2212</p> <p>VKHB 2211</p>	<p>JH415647-99401</p> <p>32311 J2</p> <p>32221 J2</p> <p>R 32217 J2/ VB128/ L 32217/Q</p>	<p>VKS 6216</p> <p>VKS 6218</p> <p>VKS 6225</p>
<p>190-25 ANW (4x4)</p>	<ul style="list-style-type: none"> ● ○ 	<p>Iveco 5965, Iveco 5975</p> <p>Iveco 4590</p>	<p>VKA 4171</p>	<ul style="list-style-type: none"> ● ● ● 	<p>VKHB 2082</p> <p>VKHB 2160</p> <p>VKHB 2215</p> <p>VKHB 2216</p>	<p>33019/Q</p> <p>32021 X/Q</p> <p>30221 J2</p> <p>32024 X</p>	<p>VKS 6214</p> <p>VKS 6218</p> <p>VKS 6225</p>
<p>190-25 AN, 190-25 ANT, 190-25 AN CKD, 190-25 AN (TAM), 190-26 H CKD, 190-26 H, 190-26 HT, 190-26 N (C.B.5), 190-26 NT (C.B.5), 190-26 N CKD, 190-25 AHT</p>	<ul style="list-style-type: none"> ● ○ 	<p>Iveco 5875</p> <p>Iveco 4590</p>	<p>VKA 4171</p>	<ul style="list-style-type: none"> ● ● ● 	<p>VKHB 2203</p> <p>VKHB 2002</p> <p>VKHB 2215</p> <p>VKHB 2216</p>	<p>JH415647-99401</p> <p>32311 J2</p> <p>30221 J2</p> <p>32024 X</p>	<p>VKS 6216</p> <p>VKS 6218</p> <p>VKS 6225</p>
<p>190-25 (256 M19), 190-29 (290 M19), 190-32 (320 M19), 190-36 (360 M19)</p>	<ul style="list-style-type: none"> ● ○ 	<p>Iveco 5875</p> <p>Iveco 4590</p>	<p>VKA 4171</p>	<ul style="list-style-type: none"> ● ● ● 	<p>VKHB 2203</p> <p>VKHB 2002</p> <p>VKHB 2215</p> <p>VKHB 2216</p>	<p>JH415647-99401</p> <p>32311 J2</p> <p>30221 J2</p> <p>32024 X</p>	<p>VKS 6216</p> <p>VKS 6218</p> <p>VKS 6225</p>
<p>190-26 HW (4x4), 190-30 HW</p>	<ul style="list-style-type: none"> ● ○ 	<p>Iveco 5965, Iveco 5975</p> <p>Iveco 4590</p>	<p>VKA 4171</p>	<ul style="list-style-type: none"> ● ● ● 	<p>VKHB 2082</p> <p>VKHB 2160</p> <p>VKHB 2215</p> <p>VKHB 2216</p>	<p>33019/Q</p> <p>32021 X/Q</p> <p>30221 J2</p> <p>32024 X</p>	<p>VKS 6214</p> <p>VKS 6218</p> <p>VKS 6225</p>
<p>190-26 Turbotech</p>	<ul style="list-style-type: none"> ● ○ ○ 	<p>Iveco 4590</p> <p>Rockwell, řUř Series</p>	<p>VKA 4171</p> <p>VKA 4169</p>	<ul style="list-style-type: none"> ● ● ● ● 	<p>VKHB 2203</p> <p>VKHB 2002</p> <p>VKHB 2215</p> <p>VKHB 2216</p> <p>VKHB 2212</p> <p>VKHB 2211</p>	<p>JH415647-99401</p> <p>32311 J2</p> <p>30221 J2</p> <p>32024 X</p> <p>32221 J2</p> <p>R 32217 J2/ VB128 /L 32217/Q</p>	<p>VKS 6216</p> <p>VKS 6218</p> <p>VKS 6225</p> <p>VKS 6218</p> <p>VKS 6225</p>
<p>190-30 H CKD</p>	<ul style="list-style-type: none"> ● ○ 	<p>Iveco 5830</p> <p>Iveco 4519</p>		<ul style="list-style-type: none"> ● ● ● 	<p>VKHB 2201</p> <p>VKHB 2202</p> <p>VKHB 2214</p> <p>VKHB 2214</p>	<p>30309 J2/Q</p> <p>30307 J2/Q</p> <p>33113/Q</p> <p>33113/Q</p>	<p>VKS 6221</p>
<p>190-30 N, 190-30 NT</p>	<ul style="list-style-type: none"> ● 	<p>Iveco 5875</p>		<ul style="list-style-type: none"> ● ● 	<p>VKHB 2203</p> <p>VKHB 2002</p>	<p>JH415647-99401</p> <p>32311 J2</p>	<p>VKS 6216</p>

									
	○ Iveco 4590			VKA 4171	●	VKHB 2215 VKHB 2216	30221 J2 32024 X	VKS 6218 VKS 6225	
190-30 PT GR. VOL., 190-30 T T/Range, 190-30 T EKO (T-UN), 190-30 P T/Range, 190-30 PT T/Range, 190-30 PT GR. VOL.T	● Iveco 5875 ○ Rockwell, U 180 E			VKA 4169	●	VKHB 2203 VKHB 2002 VKHB 2212 VKHB 2211	JH415647-99401 32311 J2 32221 J2 R 32217 J2/ VB128/ L 32217/Q	VKS 6216 VKS 6218 VKS 6225	
190E31 (4x2), 190E42 (4x2) Eurotrakker	●		VKBA 5343		●	VKHB 2024 VKHB 2252 VKHB 2215 VKHB 2216	T2ED 070/ QCLNVB061 R 33114/ QCLNVQ276/ L 33114/ QCLNVQ276 30221 J2 32024 X	VKS 6326	
190E31 (4x4), 190E42 (4x4) Eurotrakker	●	○			●	VKHB 2082 VKHB 2160 VKHB 2215 VKHB 2216	33019/Q 32021 X/Q 30221 J2 32024 X		
190-32 P GR. VOL., 190-32 PT GR. VOL.	● Iveco 5875 ○ Rockwell, U 180 E			VKA 4169	●	VKHB 2203 VKHB 2002 VKHB 2212 VKHB 2211	JH415647-99401 32311 J2 32221 J2 R 32217 J2/ VB128/ L 32217/Q	VKS 6216 VKS 6218 VKS 6225	
190-35	● Iveco 5865 ○ Iveco 4560				●	VKHB 2013 VKHB 2303 VKHB 2212	6386/K-6320/Q 32310 TN9 32221 J2	VKS 6215	
190-36 T T/Star, 190-36 P T/Star, 190-36 T T/Range, 190-38 (T-UN), 190-38 T (T-UN)	● Iveco 5875 ○ Rockwell, U 180 E			VKA 4169	●	VKHB 2203 VKHB 2002 VKHB 2212 VKHB 2211	JH415647-99401 32311 J2 32221 J2 R 32217 J2/ VB128/ L 32217/Q	VKS 6216 VKS 6218 VKS 6225	
190-36 T/Range, 190-36 PT T/Star, 190-36 P T/Range, 190-36 PT T/Range, 190-36 T/Star,	● Iveco 5875 ○ Rockwell, U 180 E			VKA 4169	●	VKHB 2203 VKHB 2002 VKHB 2212 VKHB 2211	JH415647-99401 32311 J2 32221 J2 R 32217 J2/ VB128/ L 32217/Q	VKS 6216 VKS 6218 VKS 6225	





FIAT IVECO .../...

190-42, 190-42 T,
190-42 P H

- Iveco 5875
- Rockwell, U 180 E

VKA 4169

- VKHB 2203
- VKHB 2002
- VKHB 2212
- VKHB 2211

JH415647-99401
32311 J2
32221 J2
R 32217 J2/
VB128/
L 32217/Q

VKS 6216
VKS 6218
VKS 6225

190E24 EUROMOVER

-
-

VKBA 5397

- VKHB 2024
- VKHB 2024
-
-

T2ED 070/
QCLNVB061
T2ED 070/
QCLNVB061

VKS 6326

190E24, 190E27,
190E30 Eurotech

-
-
-

VKBA 5343

VKA 4169

- VKHB 2024
- VKHB 2252
- VKHB 2212
- VKHB 2211
- VKHB 2212
- VKHB 2211

T2ED 070/
QCLNVB061
R 33114/
QCLNVQ276/
L 33114/
QCLNVQ276
32221 J2
R 32217 J2/
VB128/
L 32217/Q
32221 J2
R 32217 J2/
VB128/
L 32217/Q

VKS 6326
VKS 6218 58)
VKS 6225 59)

190E24, 190E31 Euro-
tech CURSOR

-
- Meritor U 177 E

VKBA 5343

VKBA 5397

- VKHB 2024
- VKHB 2252
-
-

T2ED 070/
QCLNVB061
R 33114/
QCLNVQ276/
L 33114/
QCLNVQ276

VKS 6326

190E30 ĩMPĭ Eurotech

-
-

VKBA 5343

- VKHB 2024
- VKHB 2252
- VKHB 2297
- VKHB 2031

T2ED 070/
QCLNVB061
R 33114/
QCLNVQ276/
L 33114/
QCLNVQ276
32220 J2
32219 J2

VKS 6326

190E30 ĩMTĭ, 190E34
Eurotech











-

VKBA 5343

- VKHB 2024
- VKHB 2252

T2ED 070/
QCLNVB061
R 33114/
QCLNVQ276/
L 33114/
QCLNVQ276

VKS 6326











									
	○			VKA 4169	●	VKHB 2212 VKHB 2211	32221 J2 R 32217 J2/ VB128/ L 32217/Q	VKS 6218	58)
	○				●	VKHB 2212 VKHB 2211	32221 J2 R 32217 J2/ VB128/ L 32217/Q	VKS 6225	59)
190E30, 190E34 Eurotrækker	●		VKBA 5343		●	VKHB 2024	T2ED 070/ QCLNVB061	VKS 6326	
	○				●	VKHB 2252	R 33114/ QCLNVQ276/ L 33114/ QCLNVQ276		
	○				●	VKHB 2215 VKHB 2216	30221 J2 32024 X		
190E35 Eurotech CURSOR	●		VKBA 5343		●	VKHB 2024	T2ED 070/ QCLNVB061	VKS 6326	
	○	Meritor U 177 E	VKBA 5397		●	VKHB 2252	R 33114/ QCLNVQ276/ L 33114/ QCLNVQ276		46)
	○				●	VKHB 2215 VKHB 2216	30221 J2 32024 X		47)
190E37 Eurotrækker	●		VKBA 5343		●	VKHB 2024	T2ED 070/ QCLNVB061	VKS 6326	
	○				●	VKHB 2252	R 33114/ QCLNVQ276/ L 33114/ QCLNVQ276		40)
	○				●	VKHB 2215 VKHB 2216	30221 J2 32024 X		41)
	○				●	VKHB 2215 VKHB 2216	30221 J2 32024 X		
190E38 Eurostar	●		VKBA 5343		●	VKHB 2024	T2ED 070/ QCLNVB061	VKS 6326	
	○				●	VKHB 2252	R 33114/ QCLNVQ276/ L 33114/ QCLNVQ276		
	○				●	VKHB 2297 VKHB 2031	32220 J2 32219 J2		48)
	○			VKA 4169	●	VKHB 2212 VKHB 2211	32221 J2 R 32217 J2/ VB128/ L 32217/Q	VKS 6218	49)
	○				●	VKHB 2212 VKHB 2211	32221 J2 R 32217 J2/ VB128/ L 32217/Q	VKS 6225	50)





FIAT IVECO .../...











190E38 Eurotech	●		VKBA 5343		● ●	VKHB 2024 VKHB 2252	T2ED 070/ QCLNVB061 R 33114/ QCLNVQ276/ L 33114/ QCLNVQ276	VKS 6326	
190E42 Eurotech	●	○ ○	VKBA 5343	VKA 4169	● ● ● ●	VKHB 2024 VKHB 2252 VKHB 2212 VKHB 2211 VKHB 2212 VKHB 2211	T2ED 070/ QCLNVB061 R 33114/ QCLNVQ276/ L 33114/ QCLNVQ276 32221 J2 R 32217 J2/ VB128/ L 32217/Q 32221 J2 R 32217 J2/ VB128/ L 32217/Q	VKS 6326 VKS 6218 VKS 6225	58) 59)
190E42, 190E47, 190E52 Eurostar	●	○ ○	VKBA 5343	VKA 4169	● ● ● ●	VKHB 2024 VKHB 2252 VKHB 2212 VKHB 2211 VKHB 2212 VKHB 2211	T2ED 070/ QCLNVB061 R 33114/ QCLNVQ276/ L 33114/ QCLNVQ276 32221 J2 R 32217 J2/ VB128/L 32217/Q 32221 J2 R 32217 J2/ VB128/ L 32217/Q	VKS 6326 VKS 6218 VKS 6225	49) 50)
190S40, 190S43, 190S48 AS STRALIS	●	○	VKBA 5397		● ● ●	VKHB 2024 VKHB 2024	T2ED 070/ QCLNVB061 T2ED 070/ QCLNVB061	VKS 6326	
190S27, 190S30, 190S31, 190S35, 190S40, 190S43 AD STRALIS	●	○	VKBA 5397		● ● ●	VKHB 2024 VKHB 2024	T2ED 070/ QCLNVB061 T2ED 070/ QCLNVB061	VKS 6326	
190S27, 190S31, 190S35, 190S40, 190S43 AT STRALIS	●				● ●	VKHB 2024 VKHB 2024	T2ED 070/ QCLNVB061 T2ED 070/ QCLNVB061	VKS 6326	

									
		<input type="radio"/>	VKBA 5397		<input type="checkbox"/>				
220-30 PT (6x2)(T-UN), 220-36 P (6x2) T/Range, 220-36 PT (6x2) T/Range	<input checked="" type="checkbox"/>	Iveco 5875			<input checked="" type="checkbox"/>	VKHB 2203	JH415647-99401	VKS 6216	
	<input type="radio"/>	Rockwell, U 180 E	VKA 4169		<input checked="" type="checkbox"/>	VKHB 2002	32311 J2	VKS 6218	
					<input checked="" type="checkbox"/>	VKHB 2212	32221 J2	VKS 6225	
					<input checked="" type="checkbox"/>	VKHB 2211	R 32217 J2/ VB128/ L 32217/Q		
220-30 T.R.U. (-01/85), 220-36 (-04/87), 220-38 T.R.U. (-01/85) -	<input checked="" type="checkbox"/>	Iveco 5875			<input checked="" type="checkbox"/>	VKHB 2203	JH415647-99401	VKS 6216	
	<input type="radio"/>	Rockwell, U 180 E	VKA 4169		<input checked="" type="checkbox"/>	VKHB 2002	32311 J2	VKS 6218	
					<input checked="" type="checkbox"/>	VKHB 2212	32221 J2	VKS 6225	
					<input checked="" type="checkbox"/>	VKHB 2211	R 32217 J2/ VB128/ L 32217/Q		
220-32 AHT	<input checked="" type="checkbox"/>	Iveco 5875			<input checked="" type="checkbox"/>	VKHB 2203	JH415647-99401	VKS 6216	
	<input type="radio"/>	Iveco 4590	VKA 4171		<input checked="" type="checkbox"/>	VKHB 2002	32311 J2	VKS 6218	
					<input checked="" type="checkbox"/>	VKHB 2215	30221 J2	VKS 6225	
					<input checked="" type="checkbox"/>	VKHB 2216	32024 X		
220-32 Turbotech, 220-36/38 Turbotech G.V.	<input checked="" type="checkbox"/>	Iveco 5875			<input checked="" type="checkbox"/>	VKHB 2203	JH415647-99401	VKS 6216	
	<input type="radio"/>	Rockwell, řÚř Series	VKA 4169		<input checked="" type="checkbox"/>	VKHB 2002	32311 J2	VKS 6218	
	<input type="radio"/>	Trailing axle			<input checked="" type="checkbox"/>	VKHB 2212	32221 J2	VKS 6225	
					<input checked="" type="checkbox"/>	VKHB 2211	R 32217 J2/ VB128/ L 32217/Q		
					<input checked="" type="checkbox"/>	VKHB 2203	JH415647-99401	VKS 6216	
					<input checked="" type="checkbox"/>	VKHB 2002	32311 J2		
220-36 (360 M22), 220-38	<input checked="" type="checkbox"/>	Iveco 5875			<input checked="" type="checkbox"/>	VKHB 2203	JH415647-99401	VKS 6216	
	<input type="radio"/>	Iveco 4590	VKA 4171		<input checked="" type="checkbox"/>	VKHB 2002	32311 J2	VKS 6218	
					<input checked="" type="checkbox"/>	VKHB 2215	30221 J2	VKS 6225	
					<input checked="" type="checkbox"/>	VKHB 2216	32024 X		
230-35 WM (6x6)	<input checked="" type="checkbox"/>	Iveco 5965			<input checked="" type="checkbox"/>	VKHB 2082	33019/Q	VKS 6214	
	<input checked="" type="checkbox"/>	Iveco 5975			<input checked="" type="checkbox"/>	VKHB 2160	32021 X/Q	VKS 6214	
	<input type="radio"/>	Iveco 4590	VKA 4171		<input checked="" type="checkbox"/>	VKHB 2082	33019/Q	VKS 6218	
					<input checked="" type="checkbox"/>	VKHB 2160	32021 X/Q	VKS 6225	
					<input checked="" type="checkbox"/>	VKHB 2215	30221 J2		
					<input checked="" type="checkbox"/>	VKHB 2216	32024 X		
240-26 Turbotech, 240-36/38 Turbotech, 240-32 Turbotech G.V., 240-36 Turbotech G.V., 240-48 Turbostar	<input checked="" type="checkbox"/>	Iveco 5875			<input checked="" type="checkbox"/>	VKHB 2203	JH415647-99401	VKS 6216	
					<input checked="" type="checkbox"/>	VKHB 2002	32311 J2		



FIAT IVECO .../...

	<ul style="list-style-type: none"> ○ Rockwell, řUř Series ○ Trailing axle 	VKA 4169	<ul style="list-style-type: none"> ● VKHB 2212 ● VKHB 2211 ● VKHB 2203 ● VKHB 2002 	32221 J2 R 32217 J2/ VB128/ L 32217/Q JH415647-99401 32311 J2	VKS 6218 VKS 6225 VKS 6216
240-26 T.R.U. (-06/88), 240-30 (-01/85), 240-30 T.R.U. (01/85), 240-36 (-04/87), 240-36 T.S. (-06/88)	<ul style="list-style-type: none"> ● Iveco 5875 ○ Rockwell, U 180 E 	VKA 4169	<ul style="list-style-type: none"> ● VKHB 2203 ● VKHB 2002 ● VKHB 2212 ● VKHB 2211 	JH415647-99401 32311 J2 32221 J2 R 32217 J2/ VB128/ L 32217/Q	VKS 6216 VKS 6218 VKS 6225
240-26, 240-30 P (6x2) (T-UN), 240-36, 240-36 T/Star, 240-36 P (6x2) T/Range, 240-42 T/Star	<ul style="list-style-type: none"> ● Iveco 5875 ○ Rockwell, U 180 E 	VKA 4169	<ul style="list-style-type: none"> ● VKHB 2203 ● VKHB 2002 ● VKHB 2212 ● VKHB 2211 	JH415647-99401 32311 J2 32221 J2 R 32217 J2/ VB128/ L 32217/Q	VKS 6216 VKS 6218 VKS 6225
240-30, 240-38	<ul style="list-style-type: none"> ● Iveco 5875 ○ Iveco 4590 	VKA 4171	<ul style="list-style-type: none"> ● VKHB 2203 ● VKHB 2002 ● VKHB 2215 ● VKHB 2216 	JH415647-99401 32311 J2 30221 J2 32024 X	VKS 6216 VKS 6218 VKS 6225
240E30 Eurotech	<ul style="list-style-type: none"> ○ Trailing axle 	VKBA 5343 VKBA 5343	<ul style="list-style-type: none"> ● VKHB 2024 ● VKHB 2252 ● VKHB 2297 ● VKHB 2031 ● VKHB 2024 ● VKHB 2252 	T2ED 070/ QCLNVB061 R 33114/ QCLNVQ276/ L 33114/ QCLNVQ276 32220 J2 32219 J2 T2ED 070/ QCLNVB061 R 33114/ QCLNVQ276/ L 33114/ QCLNVQ276	VKS 6326 VKS 6326
240E34 Eurotech		VKBA 5343	<ul style="list-style-type: none"> ● VKHB 2024 ● VKHB 2252 	T2ED 070/ QCLNVB061 R 33114/ QCLNVQ276/ L 33114/ QCLNVQ276	VKS 6326

									
		<input type="radio"/>			<ul style="list-style-type: none"> ● VKHB 2210 ● VKHB 2211 ● VKHB 2024 ● VKHB 2252 	32219 J2/ VB129 R 32217 J2/ VB128/ L 32217/Q T2ED 070/ QCLNVB061 R 33114/ QCLNVQ276/ L 33114/ QCLNVQ276		VKS 6326	
240E38 Eurostar		<input checked="" type="radio"/> <input type="radio"/> <input type="radio"/> <input type="radio"/> Trailing axle	VKBA 5343		<ul style="list-style-type: none"> ● VKHB 2024 ● VKHB 2252 ● VKHB 2297 ● VKHB 2031 ● VKHB 2210 ● VKHB 2211 ● VKHB 2024 ● VKHB 2252 	T2ED 070/ QCLNVB061 R 33114/ QCLNVQ276/ L 33114/ QCLNVQ276 32220 J2 32219 J2 32219 J2/ VB129 R 32217 J2/ VB128/ L 32217/Q T2ED 070/ QCLNVB061 R 33114/ QCLNVQ276/ L 33114/ QCLNVQ276	VKS 6326	48) 51)	
240E42, 240E47, 240E52 Eurostar		<input checked="" type="radio"/> <input type="radio"/> <input type="radio"/> <input type="radio"/> <input type="radio"/> Trailing axle	VKBA 5343	VKA 4169	<ul style="list-style-type: none"> ● VKHB 2024 ● VKHB 2252 ● VKHB 2210 ● VKHB 2211 ● VKHB 2212 ● VKHB 2211 ● VKHB 2212 ● VKHB 2211 ● VKHB 2024 ● VKHB 2252 	T2ED 070/ QCLNVB061 R 33114/ QCLNVQ276/ L 33114/ QCLNVQ276 32219 J2/ VB129 R 32217 J2/ VB128/ L 32217/Q 32221 J2 R 32217 J2/ VB128/ L 32217/Q 32221 J2 R 32217 J2/ VB128/ L 32217/Q T2ED 070/ QCLNVB061 R 33114/ QCLNVQ276/ L 33114/ QCLNVQ276	VKS 6326	52) 53) 54) 55)	





FIAT IVECO

.../...

○ Trailing axle

- VKHB 2210 32219 J2/
VB129
- VKHB 2211 R 32217 J2/
VB128/
L 32217/Q

56)

260-25 AH (6x4),
260-30 AH (6x6),
260-32 AH Army,
260-35 HM (6x4),
260-35 HM (6x6)

- Iveco 5875
- Iveco 4590

VKA 4171

- VKHB 2203 JH415647-
99401
- VKHB 2002 32311 J2
- VKHB 2215 30221 J2
- VKHB 2216 32024 X

VKS 6216

VKS 6218

VKS 6225

260-25 AHW (6x6),
260-26 NW (6x6),
260-35 HWM (6x6),
260-35 WM (6x6)

- Iveco 5965
- Iveco 5975
- Iveco 4590

VKA 4171

- VKHB 2082 33019/Q
- VKHB 2160 32021 X/Q
- VKHB 2082 33019/Q
- VKHB 2160 32021 X/Q
- VKHB 2215 30221 J2
- VKHB 2216 32024 X

VKS 6214

VKS 6214

VKS 6218

VKS 6225

260-32 Turbotech,
260-36/38 Turbotech,
260-36/38 Turbostar,
260-48 Turbostar

- Iveco 5875
- Rockwell, ïŰ Series
- Rockwell,
R130-S180
- Calabrese

VKA 4169

- VKHB 2203 JH415647-
99401
- VKHB 2002 32311 J2
- VKHB 2212 32221 J2
- VKHB 2211 R 32217 J2/
VB128/
L 32217/Q
- VKHB 2210 32219 J2/
VB129
- VKHB 2211 R 32217 J2/
VB128/
L 32217/Q
- VKHB 2178 33118 TN9/
QVT621
- VKHB 2051 33213/Q

VKS 6216

VKS 6218

VKS 6225

260-36 T/Star, 260-36 T
T/Star, 260-42 T/Star,
260-42 T T/Star

- Iveco 5875
- Rockwell, U 180 E

VKA 4169

- VKHB 2203 JH415647-
99401
- VKHB 2002 32311 J2
- VKHB 2212 32221 J2
- VKHB 2211 R 32217 J2/
VB128/
L 32217/Q

VKS 6216

VKS 6218

VKS 6225

260E23 Eurocargo

- Rockwell,
H125-P130











- VKHB 2211 R 32217 J2/
VB128/
L 32217/Q
- VKHB 2137 JM 714249/
210/Q

260E24 EUROMOVER

-

- VKHB 2024 T2ED 070/
QCLNVB061
- VKHB 2024 T2ED 070/
QCLNVB061

VKS 6326

									
	<input type="radio"/>		VKBA 5397		<input checked="" type="radio"/>				
260E28KE TECTOR 260E28 TECTOR RESTYL.	<input checked="" type="radio"/>	<input type="radio"/>			<input checked="" type="radio"/>	VKHB 2024	T2ED 070/ QCLNVB061		
		<input type="radio"/>			<input checked="" type="radio"/>	VKHB 2024	T2ED 070/ QCLNVB061		
		<input type="radio"/>			<input checked="" type="radio"/>	VKHB 2211	R 32217 J2/ VB128/ L 32217/Q		
		<input checked="" type="radio"/>			<input checked="" type="radio"/>	VKHB 2028	33215/Q		
260E24 (6x2), 260E31 (6x2), 260 E35 (6x2) Eu- rotech CURSOR	<input checked="" type="radio"/>	<input type="radio"/>	VKBA 5343		<input checked="" type="radio"/>	VKHB 2024	T2ED 070/ QCLNVB061	VKS 6326	
		<input type="radio"/>	Meritor U 177 E	VKBA 5397	<input checked="" type="radio"/>	VKHB 2252	R 33114/ QCLNVQ276/ L 33114/ QCLNVQ276		
		<input type="radio"/>	Trailing axle	VKBA 5343	<input checked="" type="radio"/>	VKHB 2024	T2ED 070/ QCLNVB061	VKS 6326	88)
		<input type="radio"/>			<input checked="" type="radio"/>	VKHB 2252	R 33114/ QCLNVQ276/ L 33114/ QCLNVQ276		
		<input type="radio"/>	Trailing axle		<input checked="" type="radio"/>	VKHB 2210	32219 J2/ VB129		87)
		<input checked="" type="radio"/>			<input checked="" type="radio"/>	VKHB 2211	R 32217 J2/ VB128/ L 32217/Q		
260E30 (6x4), 260E34 (6x4) Eurotrækker	<input checked="" type="radio"/>	<input type="radio"/>	VKBA 5343		<input checked="" type="radio"/>	VKHB 2024	T2ED 070/ QCLNVB061	VKS 6326	
		<input type="radio"/>	Forward rear		<input checked="" type="radio"/>	VKHB 2252	R 33114/ QCLNVQ276/ L 33114/ QCLNVQ276		
		<input type="radio"/>	Rear rear		<input checked="" type="radio"/>	VKHB 2215	30221 J2		42)
		<input type="radio"/>	Rear rear		<input checked="" type="radio"/>	VKHB 2216	32024 X		
		<input type="radio"/>			<input checked="" type="radio"/>	VKHB 2215	30221 J2		43)
		<input type="radio"/>			<input checked="" type="radio"/>	VKHB 2216	32024 X		
260E31 (6x4), 260E35 (6x4) Eurotrækker CUR- SOR	<input checked="" type="radio"/>	<input type="radio"/>	VKBA 5343		<input checked="" type="radio"/>	VKHB 2024	T2ED 070/ QCLNVB061	VKS 6326	
		<input type="radio"/>	Forward rear		<input checked="" type="radio"/>	VKHB 2252	R 33114/ QCLNVQ276/ L 33114/ QCLNVQ276		
		<input type="radio"/>	Rear rear		<input checked="" type="radio"/>	VKHB 2215	30221 J2		
		<input type="radio"/>			<input checked="" type="radio"/>	VKHB 2216	32024 X		
		<input type="radio"/>			<input checked="" type="radio"/>	VKHB 2215	30221 J2		
		<input type="radio"/>			<input checked="" type="radio"/>	VKHB 2216	32024 X		





FIAT IVECO .../...

260E38, 260E44,
260E48 E.TRAK CURSOR



VKHB 2024

VKHB 2024

VKHB 2215

VKHB 2216

T2ED 070/
QCLNVB061
T2ED 070/
QCLNVB061

30221 J2
32024 X

VKS 6326

VKS 6225

260E39 E.STAR CURSOR



VKHB 2024

VKHB 2024

T2ED 070/
QCLNVB061
T2ED 070/
QCLNVB061

VKBA 5397

VKS 6326

260E37 (6x4) Euro-
trækker



Forward rear



Forward rear



Rear rear



Rear rear



Rear rear

VKBA 5343



VKHB 2024

VKHB 2252

VKHB 2215

VKHB 2216

VKHB 2215

VKHB 2216

VKHB 2215

VKHB 2216

VKHB 2215

VKHB 2216

VKHB 2215

VKHB 2216

T2ED 070/
QCLNVB061
R 33114/
QCLNVQ276/
L 33114/
QCLNVQ276

30221 J2
32024 X

30221 J2
32024 X

30221 J2
32024 X

30221 J2
32024 X

30221 J2
32024 X

VKS 6326

40)

41)

44)

45)

41)

260E38, 260E42 Euro-
tech



VKHB 2024

VKHB 2252

VKHB 2210

VKHB 2211

T2ED 070/
QCLNVB061
R 33114/
QCLNVQ276/
L 33114/
QCLNVQ276

32219 J2/
VB129
R 32217 J2/
VB128/
L 32217/Q

VKBA 5343

VKS 6326

260E42, 260E47,
260E52 Eurostar



VKHB 2024

VKHB 2252

VKHB 2210











VKHB 2211

T2ED 070/
QCLNVB061
R 33114/
QCLNVQ276/
L 33114/
QCLNVQ276

32219 J2/
VB129
R 32217 J2/
VB128/L
32217/Q

VKBA 5343

VKS 6326

									
260E42 (6x4) Euro-trakker	●	○ Forward rear ○ Rear rear	VKBA 5343		● VKHB 2024 ● VKHB 2252 ● VKHB 2215 ● VKHB 2216 ● VKHB 2215 ● VKHB 2216	T2ED 070/ QCLNVB061 R 33114/ QCLNVQ276/ L 33114/ QCLNVQ276 30221 J2 32024 X 30221 J2 32024 X	VKS 6326		
260E42 (6x6) Euro-trakker	●	○ Forward rear ○ Rear rear			● VKHB 2082 ● VKHB 2160 ● VKHB 2215 ● VKHB 2216 ● VKHB 2215 ● VKHB 2216	33019/Q 32021 X/Q 30221 J2 32024 X 30221 J2 32024 X			
260E47 (6x4) Euro-trakker	●	○ Forward rear ○ Rear rear	VKBA 5343		● VKHB 2024 ● VKHB 2252 ● VKHB 2215 ● VKHB 2216 ● VKHB 2215 ● VKHB 2216	T2ED 070/ QCLNVB061 R 33114/ QCLNVQ276/ L 33114/ QCLNVQ276 30221 J2 32024 X 30221 J2 32024 X	VKS 6326		
260S40, 260S43, 260S44 260S48, 260S54 STRALIS	●	○	VKBA 5397		● VKHB 2024 ● VKHB 2024 ●	T2ED 070/ QCLNVB061 T2ED 070/ QCLNVB061	VKS 6326		
260S43, 260S40, 260S48, 260S54 AS STRALIS	●	○	VKBA 5397		● VKHB 2024 ● VKHB 2024 ●	T2ED 070/ QCLNVB061 T2ED 070/ QCLNVB061	VKS 6326		
260S27, 260S30, 260S31, 260S35, 260S40, 260S43 AD STRALIS	●	○	VKBA 5397		● VKHB 2024 ● VKHB 2024 ●	T2ED 070/ QCLNVB061 T2ED 070/ QCLNVB061	VKS 6326		
260S27, 260S31, 260S35 260S40, 260S43 AT STRALIS	●	○	VKBA 5397		● VKHB 2024 ● VKHB 2024 ●	T2ED 070/ QCLNVB061 T2ED 070/ QCLNVB061	VKS 6326		





FIAT IVECO

.../...

280E23 Eurocargo

- Rockwell, R130-S180

- VKHB 2210 32219 J2/
VB129
- VKHB 2211 R 32217 J2/
VB128/L
32217/Q

300-30 AH (8x4)

- Iveco 5875
- Iveco 4590

VKA 4171

- VKHB 2203 JH415647-994
01
 - VKHB 2002 32311 J2
 - VKHB 2215 30221 J2
 - VKHB 2216 32024 X
- VKS 6216
- VKS 6218
- VKS 6225

300-32AH, 300-34AH

-
-

- VKHB 2203 JH415647-994
01
 - VKHB 2002 32311 J2
 - VKHB 2215 30221 J2
 - VKHB 2216 32024 X
- VKS 6216
- VKS 6225

320 D 26 AK CKD

- Iveco 5830
- Iveco 4519

- VKHB 2201 30309 J2/Q
 - VKHB 2202 30307 J2/Q
 - VKHB 2214 33113/Q
 - VKHB 2214 33113/Q
- VKS 6221
- VKS 6221

320-45 HWMT (6x6),

- Iveco 5965,
Iveco 5975
- Iveco 4590

VKA 4171

- VKHB 2082 33019/Q
 - VKHB 2160 32021 X/Q
 - VKHB 2215 30221 J2
 - VKHB 2216 32024 X
- VKS 6214
- VKS 6218
- VKS 6225

320E27 Eurocargo









- Rockwell, R130-S180

- VKHB 2210 32219 J2/
VB129
- VKHB 2211 R 32217 J2/
VB128/
L 32217/Q

320E28T TECTOR

-
-

- VKHB 2339 R 33211/
QCLNVB324/
L 33211/
QCLNVQ276
- VKHB 2339 R 33211/
QCLNVB324/
L 33211/
QCLNVQ276
- VKHB 2210 32219 J2/
VB129
- VKHB 2211 R 32217 J2/
VB128/
L 32217/Q

								
325E27 Eurotech	●	○	VKBA 5343		●	VKHB 2024	T2ED 070/ QCLNVB061	VKS 6326
					●	VKHB 2252	R 33114/ QCLNVQ276/ L 33114/ QCLNVQ276	
					●	VKHB 2210	32219 J2/ VB129	
					●	VKHB 2211	R 32217 J2/ VB128/ L 32217/Q	
330-25 AN (TAM), 330-26 H (6x4), 330-26 HT (6x4), 330-30 H (6x4), 330-30 HT (6x4), 330-30 H CKD, 330-30 HT (6x4) CKD, 330-30 H (6x4) CKD, 330-30 N, 330-35 H (6x4), 330-35 H (6x4) CKD, 330-35 HT (6x4)	●	○	Iveco 5875	VKA 4171	●	VKHB 2203	JH415647- 99401	VKS 6216
			Iveco 4590		●	VKHB 2002	32311 J2	VKS 6218
					●	VKHB 2215	30221 J2	VKS 6225
					●	VKHB 2216	32024 X	
330-26 HW (6x6), 330-26 HWT (6x6), 330-30 HW (6x6), 330-30 NW (6x6), 330-30 ANW (6x6), 330-32 ANW (6x6), 330-35 HW (6x6), 330-35 HW (6x6) CKD	●	○	Iveco 5965, Iveco 5975	VKA 4171	●	VKHB 2082	33019/Q	VKS 6214
			Iveco 4590		●	VKHB 2160	32021 X/Q	VKS 6218
					●	VKHB 2215	30221 J2	VKS 6225
					●	VKHB 2216	32024 X	
330E34 (6x4), 330E37 (6x4) Eurotrakker	●	○	VKBA 5343		●	VKHB 2024	T2ED 070/ QCLNVB061	VKS 6326
					●	VKHB 2252	R 33114/ QCLNVQ276/ L 33114/ QCLNVQ276	
					●	VKHB 2215	30221 J2	
					●	VKHB 2216	32024 X	
340E34 (8x4), 340E37 (8x4), 340E42 (8x4) Eurotrakker	●	○	Forward front	VKBA 5343	●	VKHB 2024	T2ED 070/ QCLNVB061	VKS 6326
			Rear front	VKBA 5343	●	VKHB 2252	R 33114/ QCLNVQ276/ L 33114/ QCLNVQ276	VKS 6326
			Forward rear		●	VKHB 2024	T2ED 070/ QCLNVB061	
			Rear rear		●	VKHB 2252	R 33114/ QCLNVQ276/ L 33114/ QCLNVQ276	
					●	VKHB 2215	30221 J2	
					●	VKHB 2216	32024 X	
					●	VKHB 2215	30221 J2	
					●	VKHB 2216	32024 X	





FIAT IVECO

.../...

340E35 (6x4) Euro-trakker CURSOR



VKBA 5343



VKHB 2024

T2ED 070/
QCLNVB061
R 33114/
QCLNVQ276/
L 33114/
QCLNVQ276

VKS 6326



VKHB 2252



VKHB 2215



VKHB 2216



VKHB 2215



VKHB 2216

○ Forward rear

○ Rear

340E42 (6x6) Euro-trakker



○ Forward rear

○ Rear rear



VKHB 2082



VKHB 2160

33019/Q
32021 X/Q



VKHB 2215



VKHB 2216

30221 J2
32024 X



VKHB 2215



VKHB 2216

30221 J2
32024 X

380E31 (6x4), 380E37 (6x4), 380E42 (6x4), 380E47 (6x4) Euro-trakker



VKBA 5343



VKHB 2024

T2ED 070/
QCLNVB061
R 33114/
QCLNVQ276/
L 33114/
QCLNVQ276

VKS 6326



VKHB 2252



VKHB 2215



VKHB 2216



VKHB 2215



VKHB 2216

○ Forward rear

○ Rear rear

380E31 (6x6), 380E37 (6x6), 380E42 (6x6) Eurotrakker



○ Forward rear

○ Rear rear



VKHB 2082



VKHB 2160

33019/Q
32021 X/Q



VKHB 2215



VKHB 2216

30221 J2
32024 X



VKHB 2215



VKHB 2216

30221 J2
32024 X

380E34 (6x4), 380E42 (6x4) Eurotrakker



VKBA 5343



VKHB 2024

T2ED 070/
QCLNVB061
R 33114/
QCLNVQ276/
L 33114/
QCLNVQ276

VKS 6326



VKHB 2252



VKHB 2215



VKHB 2216

30221 J2
32024 X

380E35 (6x4) Euro-trakker CURSOR



VKBA 5343













VKHB 2024

T2ED 070/
QCLNVB061
R 33114/
QCLNVQ276/
L 33114/
QCLNVQ276

VKS 6326



VKHB 2252

									
	<input type="radio"/> Forward rear <input type="radio"/> Rear				<input checked="" type="radio"/> <input checked="" type="radio"/>	VKHB 2215 VKHB 2216 VKHB 2215 VKHB 2216	30221 J2 32024 X 30221 J2 32024 X		
380E38, 380E44, 380E48 E.TRAK CURSOR	<input checked="" type="radio"/> <input type="radio"/>				<input checked="" type="radio"/> <input checked="" type="radio"/>	VKHB 2024 VKHB 2024 VKHB 2215 VKHB 2216	T2ED 070/ QCLNVB061 T2ED 070/ QCLNVB061 30221 J2 32024 X	VKS 6326 VKS 6225	
400E30, 400E34 ĩMPĭ 400E34 ĩMTĭ Eurotech	<input checked="" type="radio"/> <input type="radio"/>		VKBA 5343		<input checked="" type="radio"/> <input checked="" type="radio"/>	VKHB 2024 VKHB 2252 VKHB 2210 VKHB 2211	T2ED 070/ QCLNVB061 R 33114/ QCLNVQ276/ L 33114/ QCLNVQ276 32219 J2/ VB129 R 32217 J2/ VB128/ L 32217/Q	VKS 6326	
400E31 (4x2), 400E34 (4x2), 400E37 (4x2), 400E42 (4x2) Euro- trækker	<input checked="" type="radio"/> <input type="radio"/>		VKBA 5343		<input checked="" type="radio"/> <input checked="" type="radio"/>	VKHB 2024 VKHB 2252 VKHB 2215 VKHB 2216	T2ED 070/ QCLNVB061 R 33114/ QCLNVQ276/ L 33114/ QCLNVQ276 30221 J2 32024 X	VKS 6326	
400E31 (4x4), 400E37 (4x4) Eurotrækker	<input checked="" type="radio"/> <input type="radio"/>				<input checked="" type="radio"/> <input checked="" type="radio"/>	VKHB 2082 VKHB 2160 VKHB 2215 VKHB 2216	33019/Q 32021 X/Q 30221 J2 32024 X		
400E34 Eurotrækker	<input checked="" type="radio"/> <input type="radio"/>		VKBA 5343		<input checked="" type="radio"/> <input checked="" type="radio"/>	VKHB 2024 VKHB 2252 VKHB 2215 VKHB 2216	T2ED 070/ QCLNVB061 R 33114/ QCLNVQ276/ L 33114/ QCLNVQ276 30221 J2 32024 X	VKS 6326	
400E35, 400E38, 400E44 E.TRAK CURSOR	<input checked="" type="radio"/> <input type="radio"/>				<input checked="" type="radio"/> <input checked="" type="radio"/>	VKHB 2024 VKHB 2024 VKHB 2215 VKHB 2216	T2ED 070/ QCLNVB061 T2ED 070/ QCLNVB061 30221 J2 32024 X	VKS 6326 VKS 6225	



FIAT IVECO .../...

400E38 Eurostar



VKBA 5343



VKHB 2024

T2ED 070/
QCLNVB061
R 33114/
QCLNVQ276/
L 33114/
QCLNVQ276

VKS 6326



VKHB 2252



VKHB 2210

32219 J2/
VB129

52)



VKHB 2211

R 32217 J2/
VB128/
L 32217/Q



VKHB 2297

32220 J2
32219 J2

57)



VKHB 2031



400E38 Eurotech



VKBA 5343



VKHB 2024

T2ED 070/
QCLNVB061
R 33114/
QCLNVQ276/
L 33114/
QCLNVQ276

VKS 6326



VKHB 2252



VKHB 2210

32219 J2/
VB129

51)



VKHB 2211

R 32217 J2/
VB128/
L 32217/Q



400E42 Eurotech



VKBA 5343



VKHB 2024

T2ED 070/
QCLNVB061
R 33114/
QCLNVQ276/
L 33114/
QCLNVQ276

VKS 6326



VKHB 2252



VKHB 2210

32219 J2/
VB129



VKHB 2211

R 32217 J2/
VB128/
L 32217/Q



400E42, 400E52 Eurostar



VKBA 5343



VKHB 2024

T2ED 070/
QCLNVB061
R 33114/
QCLNVQ276/
L 33114/
QCLNVQ276

VKS 6326



VKHB 2252



VKHB 2210

32219 J2/
VB129



VKHB 2211

R 32217 J2/
VB128/
L 32217/Q



400E47 EUROSTAR



VKBA 5397



VKHB 2024











T2ED 070/
QCLNVB061
T2ED 070/
QCLNVB061

VKS 6326



VKHB 2024



									
40-10 W S, 40-10 W (4x4), 40-10 W V, 40-10 W C, 40-10 W D	<ul style="list-style-type: none"> ● Iveco 5912 ○ Iveco 4512 				<ul style="list-style-type: none"> ● VKHB 2060 ● VKHB 2060 ● VKHB 2059 ● VKHB 2060 	32011 X/Q 32011 X/Q 33111/Q 32011 X/Q		VKS 6221	
40-10 WM (4x4)	<ul style="list-style-type: none"> ● Iveco 5913 ○ Iveco 4512 				<ul style="list-style-type: none"> ● VKHB 2199 ● VKHB 2199 ● VKHB 2059 ● VKHB 2060 	32013 X/Q 32013 X/Q 33111/Q 32011 X/Q		VKS 6221	
410E35 (6x4) Euro-trakker CURSOR	<ul style="list-style-type: none"> ● ○ Forward rear ○ Rear rear 		VKBA 5343		<ul style="list-style-type: none"> ● VKHB 2024 ● VKHB 2252 ● VKHB 2215 ● VKHB 2216 ● VKHB 2215 ● VKHB 2216 	T2ED 070/ QCLNVB061 R 33114/ QCLNVQ276/ L 33114/ QCLNVQ276 30221 J2 32024 X 30221 J2 32024 X		VKS 6326	
410E38, 410E44, 410E48 E.TRAK CURSOR	<ul style="list-style-type: none"> ● ○ 				<ul style="list-style-type: none"> ● VKHB 2024 ● VKHB 2024 ● VKHB 2216 ● VKHB 2215 	T2ED 070/ QCLNVB061 T2ED 070/ QCLNVB061 32024 X 30221 J2		VKS 6326 VKS 6225	
410E37 (8x4), 410E42 (8x4) Eurotrakker	<ul style="list-style-type: none"> ● Forward front ● Rear front ○ Forward rear ○ Rear rear 		VKBA 5343 VKBA 5343		<ul style="list-style-type: none"> ● VKHB 2024 ● VKHB 2252 ● VKHB 2024 ● VKHB 2252 ● VKHB 2215 ● VKHB 2216 ● VKHB 2215 ● VKHB 2216 	T2ED 070/ QCLNVB061 R 33114/ QCLNVQ276/ L 33114/ QCLNVQ276 T2ED 070/ QCLNVB061 R 33114/ QCLNVQ276/ L 33114/ QCLNVQ276 30221 J2 32024 X 30221 J2 32024 X		VKS 6326 VKS 6326	
410E42 (6x6) Euro-trakker	<ul style="list-style-type: none"> ● ○ Forward rear ○ Rear rear 				<ul style="list-style-type: none"> ● VKHB 2082 ● VKHB 2160 ● VKHB 2215 ● VKHB 2216 ● VKHB 2215 ● VKHB 2216 	33019/Q 32021 X/Q 30221 J2 32024 X 30221 J2 32024 X			





FIAT IVECO

.../...

440E31, 440E35 Euro-
tech CURSOR



VKBA 5343



VKHB 2024

T2ED 070/
QCLNVB061
R 33114/
QCLNVQ276/
L 33114/
QCLNVQ276

VKS 6326



VKHB 2252



Meritor U 177 E

VKBA 5397



440E34 Eurotech



VKBA 5343



VKHB 2024

T2ED 070/
QCLNVB061
R 33114/
QCLNVQ276/
L 33114/
QCLNVQ276

VKS 6326



VKHB 2252



VKA 4169



VKHB 2212

32221 J2
R 32217 J2/
VB128/
L 32217/Q

VKS 6218

58)



VKHB 2211



VKHB 2212

32221 J2
R 32217 J2/
VB128/
L 32217/Q

VKS 6225

59)



VKHB 2211

440E38 EUROTECH



VKBA 5397



VKHB 2024

T2ED 070/
QCLNVB061
T2ED 070/
QCLNVB061

VKS 6326



VKHB 2024



440E34 (6x4), 440E42
(6x4) Eurotrakker



VKBA 5343



VKHB 2024

T2ED 070/
QCLNVB061
R 33114/
QCLNVQ276/
L 33114/
QCLNVQ276

VKS 6326



VKHB 2252



Forward rear



VKHB 2215

30221 J2
32024 X



Rear rear



VKHB 2216



VKHB 2215

30221 J2
32024 X



VKHB 2216

440E37 (6x4) Euro-
trakker



VKBA 5343



VKHB 2024

T2ED 070/
QCLNVB061
R 33114/
QCLNVQ276/
L 33114/
QCLNVQ276

VKS 6326



VKHB 2252



Forward rear



VKHB 2215

30221 J2
32024 X



Rear rear



VKHB 2216













VKHB 2215

30221 J2
32024 X



VKHB 2216

46)











									
		<input type="radio"/> Rear rear			<input checked="" type="checkbox"/>	VKHB 2215 VKHB 2216	30221 J2 32024 X		47)
440E38, 440E44 E.TRAK CURSOR	<input checked="" type="checkbox"/>	<input type="radio"/>			<input checked="" type="checkbox"/>	VKHB 2024 VKHB 2024 VKHB 2215 VKHB 2216	T2ED 070/ QCLNVB061 T2ED 070/ QCLNVB061 30221 J2 32024 X	VKS 6326 VKS 6225	
440E38 Eurostar	<input checked="" type="checkbox"/>	<input type="radio"/> <input type="radio"/> <input type="radio"/>	VKBA 5343	VKA 4169	<input checked="" type="checkbox"/> <input checked="" type="checkbox"/> <input checked="" type="checkbox"/> <input checked="" type="checkbox"/> <input checked="" type="checkbox"/>	VKHB 2024 VKHB 2252 VKHB 2297 VKHB 2031 VKHB 2212 VKHB 2211 VKHB 2212 VKHB 2211	T2ED 070/ QCLNVB061 R 33114/ QCLNVQ276/ L 33114/ QCLNVQ276 32220 J2 32219 J2 32221 J2 R 32217 J2/ VB128/ L 32217/Q 32221 J2 R 32217 J2/ VB128/ L 32217/Q	VKS 6326 VKS 6218 VKS 6225	48) 49) 50)
440E39, 440E43 Euro-tech Cursor	<input checked="" type="checkbox"/>	<input type="radio"/> Meritor U 177 E	VKBA 5343 VKBA 5397		<input checked="" type="checkbox"/> <input checked="" type="checkbox"/> <input checked="" type="checkbox"/>	VKHB 2024 VKHB 2252	T2ED 070/ QCLNVB061 R 33114/ QCLNVQ276/ L 33114/ QCLNVQ276	VKS 6326	
440E42 (4x2) Eurotech	<input checked="" type="checkbox"/>	<input type="radio"/> <input type="radio"/>	VKBA 5343	VKA 4169	<input checked="" type="checkbox"/> <input checked="" type="checkbox"/> <input checked="" type="checkbox"/> <input checked="" type="checkbox"/>	VKHB 2024 VKHB 2252 VKHB 2212 VKHB 2211 VKHB 2212 VKHB 2211	T2ED 070/ QCLNVB061 R 33114/ QCLNVQ276/ L 33114/ QCLNVQ276 32221 J2 R 32217 J2/ VB128/ L 32217/Q 32221 J2 R 32217 J2/ VB128/ L 32217/Q	VKS 6326 VKS 6218 VKS 6225	58) 59)
440E42 (4x2), 440E47 (4x2), 440E52 (4x2) Eurostar	<input checked="" type="checkbox"/>		VKBA 5343		<input checked="" type="checkbox"/> <input checked="" type="checkbox"/>	VKHB 2024 VKHB 2252	T2ED 070/ QCLNVB061 R 33114/ QCLNVQ276/ L 33114/ QCLNVQ276	VKS 6326	





FIAT IVECO .../...











	<input type="radio"/>		VKA 4169	<ul style="list-style-type: none"> ● VKHB 2212 ● VKHB 2211 	<ul style="list-style-type: none"> ● 32221 J2 ● R 32217 J2/ VB128/ L 32217/Q 	VKS 6218 58)
	<input type="radio"/>			<ul style="list-style-type: none"> ● VKHB 2212 ● VKHB 2211 	<ul style="list-style-type: none"> ● 32221 J2 ● R 32217 J2/ VB128/ L 32217/Q 	VKS 6225 59)
440E39, 440E43, 440E46, 440E48 E.STAR CURSOR	<ul style="list-style-type: none"> ● <input type="radio"/> 		VKBA 5397	<ul style="list-style-type: none"> ● VKHB 2024 ● VKHB 2024 ● ● 	<ul style="list-style-type: none"> ● T2ED 070/ QCLNVB061 ● T2ED 070/ QCLNVB061 	VKS 6326
440E42 (6x2) Eurotech	<ul style="list-style-type: none"> ● <input type="radio"/> <input type="radio"/> <input type="radio"/> <input type="radio"/> <input type="radio"/> <input type="radio"/> <input type="radio"/> 	Trailing axle	VKBA 5343	<ul style="list-style-type: none"> ● VKHB 2024 ● VKHB 2252 ● VKHB 2210 ● VKHB 2211 ● VKA 4169 ● VKHB 2212 ● VKHB 2211 ● VKHB 2212 ● VKHB 2211 ● VKHB 2024 ● VKHB 2252 	<ul style="list-style-type: none"> ● T2ED 070/ QCLNVB061 ● R 33114/ QCLNVQ276/ L 33114/ QCLNVQ276 ● 32219 J2/ VB129 ● R 32217 J2/ VB128/ L 32217/Q ● 32221 J2 ● R 32217 J2/ VB128/ L 32217/Q ● 32221 J2 ● R 32217 J2/ VB128/ L 32217/Q ● T2ED 070/ QCLNVB061 ● R 33114/ QCLNVQ276/ L 33114/ QCLNVQ276 	VKS 6326 48) VKS 6218 49) VKS 6225 50) VKS 6326
440E42 (6x4) Eurotech	<ul style="list-style-type: none"> ● <input type="radio"/> 		VKBA 5343	<ul style="list-style-type: none"> ● VKHB 2024 ● VKHB 2252 ● VKHB 2210 ● VKHB 2211 	<ul style="list-style-type: none"> ● T2ED 070/ QCLNVB061 ● R 33114/ QCLNVQ276/ L 33114/ QCLNVQ276 ● 32219 J2/ VB129 ● R 32217 J2/ VB128/ L 32217/Q 	VKS 6326

									
440E42 (6x4), 440E52 (6x4) Eurostar	●	○	VKBA 5343		●	VKHB 2024	T2ED 070/ QCLNVB061	VKS 6326	
					●	VKHB 2252	R 33114/ QCLNVQ276/ L 33114/ QCLNVQ276		
					●	VKHB 2210	32219 J2/ VB129		
					●	VKHB 2211	R 32217 J2/ VB128/ L 32217/Q		
440S40, 440S43, 440S44 440S48, 440S54 STRALIS	●	○	VKBA 5397		●	VKHB 2024	T2ED 070/ QCLNVB061	VKS 6326	
					●	VKHB 2024	T2ED 070/ QCLNVB061		
					●				
					●				
440S40, 440S43, 440S48, 440S54 AS STRALIS	●	○	VKBA 5397		●	VKHB 2024	T2ED 070/ QCLNVB061	VKS 6326	
					●	VKHB 2024	T2ED 070/ QCLNVB061		
					●				
					●				
440S31, 440S35, 440S40, 440S43 AD STRALIS	●	○	VKBA 5397		●	VKHB 2024	T2ED 070/ QCLNVB061	VKS 6326	
					●	VKHB 2024	T2ED 070/ QCLNVB061		
					●				
					●				
440S31, 440S35, 440S40 440S43 AT STRALIS	●				●	VKHB 2024	T2ED 070/ QCLNVB061	VKS 6326	
					●	VKHB 2024	T2ED 070/ QCLNVB061		
440S31, 440S40, 440S43 AT STRALIS		○	VKBA 5397		●				
					●				
50-9	●	Iveco 5822			●	VKHB 2201	30309 J2/Q	VKS 6221	28)
		Iveco 4516 HD			●	VKHB 2202	30307 J2/Q		
	○				●	VKHB 2154	32014 X/Q	VKS 6221	29)
					●	VKHB 2154	32014 X/Q		
	○	Iveco 4419			●	VKHB 2214	33113/Q	VKS 6221	30)
					●	VKHB 2214	33113/Q		
50-9 Zeta, 50-10 Zeta	●				●	VKHB 2201	30309 J2/Q		
					●	VKHB 2202	30307 J2/Q		



FIAT IVECO .../...

	○			●	●	VKHB 2154 VKHB 2154	32014 X/Q 32014 X/Q	VKS 6221
55-8 (I-Serie), 55-9 (I-Serie), 55-10 (I-Serie), A 55-10 (I-II-Serie)	●	Iveco 5822 Iveco 5830		●	●	VKHB 2201 VKHB 2202	30309 J2/Q 30307 J2/Q	
	○	Iveco 4516		●	●	VKHB 2214 VKHB 2214	33113/Q 33113/Q	VKS 6221
60-11 Turbozeta	●			●	●	VKHB 2201 VKHB 2202	30309 J2/Q 30307 J2/Q	
	○			●	●	VKHB 2154 VKHB 2154	32014 X/Q 32014 X/Q	VKS 6221
60-8 (III-Serie), 60-10 (I-II-Serie), A 60-10 (I-II-Serie)	●	Iveco 5822, Iveco 5830		●	●	VKHB 2201 VKHB 2202	30309 J2/Q 30307 J2/Q	
	○	Iveco 4516		●	●	VKHB 2214 VKHB 2214	33113/Q 33113/Q	VKS 6221
60E10, 60E12, 60E14, Eurocargo	●	Iveco 5827		●	●	VKHB 2250 VKHB 2250	JXC25370CA-90KA2 JXC25370CA-90KA2	VKS 6316
	○	Iveco 4517	VKBA 5274	●	●	VKHB 2209 VKHB 2209	BT1B 329138/ 34478/2/ QVQ276 BT1B 329138/ 34478/2/ QVQ276	VKS 6326
619 T 1P, 619 N 1P CKD	●	Iveco 5875		●	●	VKHB 2203 VKHB 2002	JH415647-99401 32311 J2	VKS 6216
	○	Iveco 4560		●	●	VKHB 2212	32221 J2	VKS 6201
65-9, 65-9 Export CKD, 65-12, 65-12 H, 65-12 V, 65-12 D	●	Iveco 5830		●	●	VKHB 2201 VKHB 2202	30309 J2/Q 30307 J2/Q	
	○	Iveco 4519		●	●	VKHB 2214 VKHB 2214	33113/Q 33113/Q	VKS 6221
65E10, 65E12, 65E12H 65E14 Eurocargo	●	Iveco 5827		●	●	VKHB 2250 VKHB 2250	JXC25370CA-90KA2 JXC25370CA-90KA2	VKS 6316

									
	<input type="radio"/>	Iveco 4517	VKBA 5274		<input checked="" type="radio"/>	VKHB 2209	BT1B 329138/ 34478/2/ QVQ276	VKS 6326	
					<input checked="" type="radio"/>	VKHB 2209	BT1B 329138/ 34478/2/ QVQ276		
70-10 (I-Serie), A 70-12 (I-II-Serie), A 70-14	<input checked="" type="radio"/>	Iveco 5830			<input checked="" type="radio"/>	VKHB 2201	30309 J2/Q	VKS 6221	
					<input checked="" type="radio"/>	VKHB 2202	30307 J2/Q		
	<input type="radio"/>	Iveco 4519			<input checked="" type="radio"/>	VKHB 2214	33113/Q		
					<input checked="" type="radio"/>	VKHB 2214	33113/Q		
70-14 Zeta	<input checked="" type="radio"/>				<input checked="" type="radio"/>	VKHB 2201	30309 J2/Q	VKS 6221	
					<input checked="" type="radio"/>	VKHB 2202	30307 J2/Q		
	<input type="radio"/>				<input checked="" type="radio"/>	VKHB 2214	33113/Q		
					<input checked="" type="radio"/>	VKHB 2214	33113/Q		
720E31 (6x4), 720E37 (6x4), 720E42 (6x4), 720E47 (6x4) Euro-trakker	<input checked="" type="radio"/>		VKBA 5343		<input checked="" type="radio"/>	VKHB 2024	T2ED 070/ QCLNVB061	VKS 6326	
					<input checked="" type="radio"/>	VKHB 2252	R 33114/ QCLNVQ276/ L 33114/ QCLNVQ276		
	<input type="radio"/>	Forward rear			<input checked="" type="radio"/>	VKHB 2215	30221 J2		
					<input checked="" type="radio"/>	VKHB 2216	32024 X		
	<input type="radio"/>	Rear rear			<input checked="" type="radio"/>	VKHB 2215	30221 J2		
					<input checked="" type="radio"/>	VKHB 2216	32024 X		
720E31 (6x6), 720E37 (6x6), 720E42 (6x6) Euro-trakker	<input checked="" type="radio"/>				<input checked="" type="radio"/>	VKHB 2082	33019/Q		
					<input checked="" type="radio"/>	VKHB 2160	32021 X/Q		
	<input type="radio"/>	Forward rear			<input checked="" type="radio"/>	VKHB 2215	30221 J2		
					<input checked="" type="radio"/>	VKHB 2216	32024 X		
	<input type="radio"/>	Rear rear			<input checked="" type="radio"/>	VKHB 2215	30221 J2		
					<input checked="" type="radio"/>	VKHB 2216	32024 X		
75-9A	<input type="radio"/>				<input checked="" type="radio"/>	VKHB 2214	33113/Q		
					<input checked="" type="radio"/>	VKHB 2214	33113/Q		
75-13 AW, 75-16 AW	<input checked="" type="radio"/>	Iveco 5918, (AVA 36)			<input checked="" type="radio"/>	VKHB 2200	47487/47420		
					<input checked="" type="radio"/>	VKHB 2169	32017 X/Q		
	<input type="radio"/>	Iveco 7899, (HA 72)			<input checked="" type="radio"/>	VKHB 2200	47487/47420		
					<input checked="" type="radio"/>	VKHB 2169	32017 X/Q		
75-13 WM (4x4), 75-14 WM	<input checked="" type="radio"/>	Iveco 5918, (AVA 36)			<input checked="" type="radio"/>	VKHB 2200	47487/47420		
					<input checked="" type="radio"/>	VKHB 2169	32017 X/Q		
	<input type="radio"/>	Iveco 4518			<input checked="" type="radio"/>	VKHB 2200	47487/47420		
					<input checked="" type="radio"/>	VKHB 2169	32017 X/Q		



FIAT IVECO .../...

75E12, 75E14, 75E15
Eurocargo

● Iveco 5827

● Iveco 5833

○ Iveco 4517

○ Iveco 4521

VKBA 5274

● VKHB 2250

● VKHB 2250

● VKHB 2249

● VKHB 2250

● VKHB 2209

● VKHB 2209

● VKHB 2253

● VKHB 2253

JXC25370CA-90KA2

JXC25370CA-90KA2

R 33209/
QCLNVB323/
L 33209/
QCLNVQ276

JXC25370CA-90KA2

BT1B 329138/
34478/2/
QVQ276

BT1B 329138/
34478/2/
QVQ276

JXC 25716 C/
JXC 25716 D

JXC 25716 C/
JXC 25716 D

VKS 6316

VKS 6316

VKS 6326

VKS 6326

75E13, 75E15, 75E17.
75E18 TECTOR, RESTYL-
ING, 75E17 EUROFIRE
TECTOR

●

○

VKBA 5274

● VKHB 2249

● VKHB 2250

● VKHB 2209

● VKHB 2209

R 33209/
QCLNVB323/
L 33209/
QCLNVQ276

JXC25370CA-90KA2

BT1B 329138/
34478/2/
QVQ276

BT1B 329138/
34478/2/
QVQ276

VKS 6326

79-11, 79-12 D, 79-12 V,
79-14, 79-14 D, 79-14 V,
79-12 CKD

●

○

Iveco 5830

Iveco 4519

● VKHB 2201

● VKHB 2202

● VKHB 2214

● VKHB 2214

30309 J2/Q

30307 J2/Q

33113/Q

33113/Q

VKS 6221

79-12 Turbozeta

●

○

● VKHB 2201

● VKHB 2202

● VKHB 2214

● VKHB 2214

30309 J2/Q

30307 J2/Q

33113/Q

33113/Q

VKS 6221

79-14 ZETA

●

○

●

● VKHB 2202











● VKHB 2214

● VKHB 2214

30307 J2/Q

33113/Q

33113/Q

									
80-13 AW (4x4), 80-16 AW (4x4)	●	Iveco 5918, (AVA 36)			●	VKHB 2067	33209/Q		
		○ Iveco 7899, (HA 72)			●	VKHB 2200 VKHB 2169	47487/47420 32017 X/Q		
80-13 A, 80-13 AH, 80-13 AT, 80-16 A	●	Iveco 5822, Iveco 5830			●	VKHB 2201 VKHB 2202	30309 J2/Q 30307 J2/Q		32)
		○ Rockwell, 125 E			●	VKHB 2208	567/563	VKS 6211	32)
80-13 (I-Serie)	●	Iveco 5822, Iveco 5830			●	VKHB 2201 VKHB 2202	30309 J2/Q 30307 J2/Q		
80-14 W, 80-17 W	●	Iveco 5918, (AVA 36)			●	VKHB 2200 VKHB 2169	47487/47420 32017 X/Q		
		○ Iveco 4518			●	VKHB 2200 VKHB 2169	47487/47420 32017 X/Q		
80E15, 80E18, 80E21, Eurocargo	●	Iveco 5833			●	VKHB 2249	R 33209/ QCLNVB323/ L 33209/ QCLNVQ276		VKS 6316
		○ Iveco 4521			●	VKHB 2250	JXC25370CA- 90KA2		
					●	VKHB 2253	JXC 25716 C/ JXC 25716 D		VKS 6326
					●	VKHB 2253	JXC 25716 C/ JXC 25716 D		
85E15, 85E18, 85E18H Eurocargo	●				●	VKHB 2249	R 33209/ QCLNVB323/ L 33209/ QCLNVQ276		VKS 6316
		○			●	VKHB 2250	JXC25370CA- 90KA2		
					●	VKHB 2253	JXC 25716 C/ JXC 25716 D		VKS 6326
					●	VKHB 2253	JXC 25716 C/ JXC 25716 D		
90-13 A (01/85-), 90-13 AH (01/85-), A 90-14 (III-IV-Serie)	●	Iveco 5822, Iveco 5830			●	VKHB 2201 VKHB 2202	30309 J2/Q 30307 J2/Q		
		○ Rockwell, 125 E			●	VKHB 2208	567/563	VKS 6211	
90-13 (I-II-Serie), A 90-13 (I-II-Serie)	●	Iveco 5822, Iveco 5830			●	VKHB 2201 VKHB 2202	30309 J2/Q 30307 J2/Q		





FIAT IVECO

.../...

90-14 WM (4x4), 90-17 WM



Iveco 5918, (AVA 36)



VKHB 2200
VKHB 2169

47487/47420
32017 X/Q



Iveco 4518



VKHB 2200
VKHB 2169

47487/47420
32017 X/Q

90-16 AW



Iveco 5918, (AVA 36)



VKHB 2200
VKHB 2169

47487/47420
32017 X/Q



Iveco 7899, (HA 72)



VKHB 2200
VKHB 2169

47487/47420
32017 X/Q

95-14 Zeta



Rockwell, F 125 E



VKHB 2201
VKHB 2202

30309 J2/Q
30307 J2/Q



VKHB 2208

567/563

VKS 6211

95-14 (III-IV-Serie)



Iveco 5822, Iveco 5830



VKHB 2201
VKHB 2202

30309 J2/Q
30307 J2/Q



Rockwell, 125 E



VKHB 2208

567/563

VKS 6211

95E15 (4x4), 95E21 (4x4) Eurocargo



VKHB 2082
VKHB 2170

33019/Q
32018 X/Q



VKHB 2168
VKHB 2331

30215 J2/Q
33118/Q

95E18 Eurocargo



VKHB 2249

R 33209/
QCLNVB323/
L 33209/
QCLNVQ276

VKS 6316



VKHB 2250

JXC25370CA-
90KA2



VKHB 2253

JXC 25716 C/
JXC 25716 D

VKS 6326



VKHB 2253

JXC 25716 C/
JXC 25716 D

95E18W EUROFIRE
95E21 EUROCARGO



VKHB 2082
VKHB 2170

33019/Q
32018 X/Q



VKHB 2168

30215 J2/Q

A 135-14 (5000), A 135-14 (5000) CKD, A 135-17 (4400) CKD, A 135-17 (5000)



Iveco 5844 M



VKHB 2173
VKHB 2061

33212/Q
33211/Q

VKS 6221



Rockwell, H 140 E



VKHB 2211

R 32217 J2/
VB128/
L 32217/Q











34)



VKHB 2137

JM 714249/
210/Q

VKS 6211











									
A175-24 175-17, 175-24, 175-24 T, 175-24 Nett. URB., 175-24 CKD	●	Iveco 5860			●	VKHB 2013	6386/K-6320/Q	VKS 6215	
	●	Iveco 5865			●	VKHB 2303	32310 TN9	VKS 6215	
	○	Rockwell, R130-S180			●	VKHB 2013	6386/K-6320/Q	VKS 6215	
	○	Rockwell, S 160 E			●	VKHB 2303	32310 TN9	VKS 6215	
					●	VKHB 2210	32219 J2/ VB129		
					●	VKHB 2211	R 32217 J2/ VB128/ L 32217/Q		
					●	VKHB 2210	32219 J2/ VB129		
					●	VKHB 2211	R 32217 J2/ VB128/ L 32217/Q		
Z 220, Z 220 Stripped chass., Z 220 T H	●	Iveco 5830			●	VKHB 2201	30309 J2/Q		
	○	Iveco 4519			●	VKHB 2202	30307 J2/Q	VKS 6221	
					●	VKHB 2214	33113/Q		
					●	VKHB 2214	33113/Q		
Z Range:50-8	●				●	VKHB 2201	30309 J2/Q		
	○				●	VKHB 2202	30307 J2/Q	VKS 6221	
					●	VKHB 2154	32014 X/Q		
					●	VKHB 2154	32014 X/Q		
Z Range: 60-10, 65-10 75-10, 79-10, 79-14	●				●	VKHB 2201	30309 J2/Q		
	○				●	VKHB 2202	30307 J2/Q	VKS 6221	
					●	VKHB 2214	33113/Q		
					●	VKHB 2214	33113/Q		
FORD									
P 100 1,6	●		VKBA 528		●				14)
P 100	●		VKBA 741		●				16)
Transit I FT 60-80 (GB)	●		VKBA 523		●				1)
	○	34	VKBA 922		●				2)
Transit I FT 60-120 (D)	●		VKBA 523		●				1)
Transit I FT 80-120	●		VKBA 523		●				1)
	●		VKBA 1465		●				11)
	○	34	VKBA 922		●				7)



FORD

.../...











	○ 34	VKBA 958	•	8)
	○ 34	VKBA 957	•	9)
	○ 34	VKBA 1466	•	11)
Transit I FT 90-120 (GB)	●	VKBA 523	•	1)
	○ 34	VKBA 922	•	3)
Transit I FT 100L (D)	●	VKBA 523	•	1)
	○ 34	VKBA 922	•	6)
Transit I FT 100L, Transit FT I 130-190	●	VKBA 523	•	1)
Transit FT I 100L, Transit FT I 130-190	○ 34	VKBA 922	•	7)
	○	VKBA 959	•	10)
Transit I FT 120-190	●	VKBA 523	•	1)
	○ 51, 52, 53	VKBA 923	•	7)
Transit I FT 125-190	●	VKBA 523	•	1)
	○ 51, 52, 53	VKBA 923	•	3)
Transit I FT 130-190	●	VKBA 1465	•	11)
	○ 53	VKBA 959	•	11)
Transit I FT 130-150, 190 L	●	VKBA 1465	•	11)
	○ 51	VKBA 1467	•	11)
Transit II	●	VKBA 3588	•	18)
	○	VKBA 3589	•	19)

									
	<input type="radio"/>		VKBA 3590		<input type="checkbox"/>				20)
Transit II 2.0 DI, 2.0 TD-Ci, 2.3 16V, 2.4 DI, 2.4 TDE	<input type="radio"/>		VKBA 3654		<input type="checkbox"/>				21)
	<input type="radio"/>		VKBA 3655		<input type="checkbox"/>				22)
Transit II	<input type="radio"/>		VKBA 959		<input type="checkbox"/>				24)
	<input type="radio"/>		VKBA 3654		<input type="checkbox"/>				25)
	<input type="radio"/>		VKBA 3655		<input type="checkbox"/>				26)
CARGO	<input checked="" type="checkbox"/>	30			<input checked="" type="checkbox"/>	VKHB 2309 VKHB 2151	25590/25520/Q LM 48548/ 510/Q		12)
	<input checked="" type="checkbox"/>	30			<input checked="" type="checkbox"/>	VKHB 2309 VKHB 2151	25590/25520/Q LM 48548/ 510/Q		13)
	<input checked="" type="checkbox"/>	50 N, 50 W			<input checked="" type="checkbox"/>	VKHB 2088 VKHB 2089	39581/39520/Q 3585/3525/Q		
	<input checked="" type="checkbox"/>	65, 71			<input checked="" type="checkbox"/>	VKHB 2050	HM 215249/HM 215210		
	<input type="radio"/>	130, 15			<input checked="" type="checkbox"/>	VKHB 2310	3780/3720/Q		
	<input type="radio"/>	195			<input checked="" type="checkbox"/>	VKHB 2311	33287/33462/Q		
	<input type="radio"/>	225			<input checked="" type="checkbox"/>	VKHB 2175	39590/39520/Q		
	<input type="radio"/>	225			<input checked="" type="checkbox"/>	VKHB 2040 VKHB 2041	594/592 A/Q 580/572/Q		
MAN									
6/8 T 4x2 F, (Type L01)	<input checked="" type="checkbox"/>	V7-36 L	VKBA 5265		<input checked="" type="checkbox"/>	VKHB 2240 VKHB 2018	BT1B 328251/Q 32207 J2/Q	VKS 6296	
	<input type="radio"/>	VW 6.1 T	VKBA 5150		<input checked="" type="checkbox"/>	VKHB 2174 VKHB 2175	547518 39590/39520/Q	VKS 6192	
	<input type="radio"/>	VW 6.8 T	VKBA 5150		<input checked="" type="checkbox"/>	VKHB 2174 VKHB 2175	547518 39590/39520/Q	VKS 6192	
8/9 T 4x2 FOC, (Type L05)	<input checked="" type="checkbox"/>	V7-36 L	VKBA 5265		<input checked="" type="checkbox"/>	VKHB 2240 VKHB 2018	BT1B 328251/Q 32207 J2/Q	VKS 6296	
	<input type="radio"/>	VW 6.1 T	VKBA 5150		<input checked="" type="checkbox"/>	VKHB 2174 VKHB 2175	547518 39590/39520/Q	VKS 6192	
	<input type="radio"/>	VW 6.8 T	VKBA 5150		<input checked="" type="checkbox"/>	VKHB 2174 VKHB 2175	547518 39590/39520/Q	VKS 6192	
10 T, 4x2 F, (Type L04)	<input checked="" type="checkbox"/>	V7-36 L	VKBA 5265		<input checked="" type="checkbox"/>	VKHB 2240 VKHB 2018	BT1B 328251/Q 32207 J2/Q	VKS 6296	



MAN .../...

	○	VW 6.8 T	VKBA 5150	●	●	VKHB 2174 VKHB 2175	547518 39590/39520/Q	VKS 6192
12 T 4x4 FA, (Type M07)	●	VA7-0540		●	●	VKHB 2169 VKHB 2282	32017 X/Q 32015 X/Q	
	○	HY-0955		●	●	VKHB 2248 VKHB 2222	30218 J2 33115/Q	VKS 6328
	○	H7-0870		●	●	VKHB 2170 VKHB 2033	32018 X/Q 32215 J2/Q	
12/13 T, 4x2 FL, (Type M02)	●	V7-42 L		●	●	VKHB 2020	32208 J2/Q	VKS 6327
	●	V7-52 L		●	●	VKHB 2067	33209/Q	VKS 6302
	○	HY-0955		●	●	VKHB 2248 VKHB 2222	30218 J2 33115/Q	VKS 6328
	○	HY-1175		●	●	VKHB 2248 VKHB 2222	30218 J2 33115/Q	VKS 6328
12/13 T, 4x2 F, (Type M01)	●	V7-52 L		●	●	VKHB 2067	33209/Q	VKS 6302
	●	V7-42 L		●	●	VKHB 2020	32208 J2/Q	VKS 6327
	○	HY-1175		●	●	VKHB 2248 VKHB 2222	30218 J2 33115/Q	VKS 6328
	○	HY-0955		●	●	VKHB 2248 VKHB 2222	30218 J2 33115/Q	VKS 6328
14/15 T, 4x2 FL, (Type M04)	●	V7-52 L		●	●	VKHB 2067	33209/Q	VKS 6302
	○	HY-1175		●	●	VKHB 2248 VKHB 2222	30218 J2 33115/Q	VKS 6328
	○	HY-0955		●	●	VKHB 2248 VKHB 2222	30218 J2 33115/Q	VKS 6328
14/15 T, 4x2 F, (Type M03)	●	V7-52 L		●	●	VKHB 2067	33209/Q	VKS 6302
	○	HY-1175		●	●	VKHB 2248 VKHB 2222	30218 J2 33115/Q	VKS 6328
	○	HY-0955		●	●	VKHB 2248 VKHB 2222	30218 J2 33115/Q	VKS 6328
16/19 T, 4x2 FLL, (Type F03)	●	V9-75 L	VKBA 5162	●	●	VKHB 2132 VKHB 2070	331933/Q 32310 J2/Q	VKS 6182
	●	V9-65 L	VKBA 5162	●	●	VKHB 2132 VKHB 2070	331933/Q 32310 J2/Q	VKS 6182
	○	H9-13120	VKBA 5160	●	●	VKHB 2163 VKHB 2164	33022 30220 J2	VKS 6183 VKS 6181

									
		<input type="radio"/> HY-13110	VKBA 5163		<input checked="" type="radio"/>	VKHB 2146 VKHB 2082	33021/QVB091 33019/Q	VKS 6189	
16/19 T, 4x2 FL, (Type F02)	<input checked="" type="radio"/>	V9-75 L	VKBA 5162		<input checked="" type="radio"/>	VKHB 2132 VKHB 2070	331933/Q 32310 J2/Q	VKS 6182	
	<input type="radio"/>	H9-10120			<input checked="" type="radio"/>	VKHB 2162 VKHB 2161	33021/Q 32019 X/Q	VKS 6183 VKS 6181	
	<input type="radio"/>	HY-13110	VKBA 5163		<input checked="" type="radio"/>	VKHB 2146 VKHB 2082	33021/QVB091 33019/Q	VKS 6189	
	<input type="radio"/>	H9-13120	VKBA 5160		<input checked="" type="radio"/>	VKHB 2163 VKHB 2164	33022 30220 J2	VKS 6183 VKS 6181	
16/19 T, 4x2 F, (Type F01)	<input checked="" type="radio"/>	V9-75 L	VKBA 5162		<input checked="" type="radio"/>	VKHB 2132 VKHB 2070	331933/Q 32310 J2/Q	VKS 6182	
	<input type="radio"/>	HY-13110	VKBA 5163		<input checked="" type="radio"/>	VKHB 2146 VKHB 2082	33021/QVB091 33019/Q	VKS 6189	
	<input type="radio"/>	H9-16120			<input checked="" type="radio"/>	VKHB 2163 VKHB 2165	33022 33220	VKS 6183 VKS 6181	
	<input type="radio"/>	H9-13120			<input checked="" type="radio"/>	VKHB 2163 VKHB 2165	33022 33220	VKS 6183 VKS 6181	4)
	<input type="radio"/>	H9-13120	VKBA 5160		<input checked="" type="radio"/>	VKHB 2163 VKHB 2164	33022 30220 J2	VKS 6183 VKS 6181	3)
	<input type="radio"/>	H9-10120			<input checked="" type="radio"/>	VKHB 2162 VKHB 2161	33021/Q 32019 X/Q	VKS 6183 VKS 6181	
16/19 T, 4x2 U (Type U01)	<input checked="" type="radio"/>	V9-75 L	VKBA 5162		<input checked="" type="radio"/>	VKHB 2132 VKHB 2070	331933/Q 32310 J2/Q	VKS 6182	
	<input type="radio"/>	H9-10120			<input checked="" type="radio"/>	VKHB 2162 VKHB 2161	33021/Q 32019 X/Q	VKS 6183 VKS 6181	
	<input type="radio"/>	H9-13120	VKBA 5160		<input checked="" type="radio"/>	VKHB 2163 VKHB 2164	33022 30220 J2	VKS 6183 VKS 6181	
	<input type="radio"/>	HY-13110	VKBA 5163		<input checked="" type="radio"/>	VKHB 2146 VKHB 2082	33021/QVB091 33019/Q	VKS 6189	
17/18 T, 4x2 FL, (Type M06)	<input checked="" type="radio"/>	V7-80 L	VKBA 5162		<input checked="" type="radio"/>	VKHB 2132 VKHB 2070	331933/Q 32310 J2/Q	VKS 6182	
	<input checked="" type="radio"/>	V7-65 L			<input checked="" type="radio"/>	VKHB 2293 VKHB 2004	BT1B 328286/Q 32309 J2/Q	VKS 6329	
	<input type="radio"/>	HY-0955			<input checked="" type="radio"/>	VKHB 2248 VKHB 2222	30218 J2 33115/Q	VKS 6328	
	<input type="radio"/>	HY-1175	VKBA 5163		<input checked="" type="radio"/>	VKHB 2146 VKHB 2082	33021/QVB091 33019/Q	VKS 6189	7)
	<input type="radio"/>	H7-1080 H7-1180			<input checked="" type="radio"/>	VKHB 2146 VKHB 2161	33021/QVB091 32019 X/Q	VKS 6334	6)
	<input type="radio"/>	H7-1080, H7-1180			<input checked="" type="radio"/>	VKHB 2146 VKHB 2161	33021/QVB091 32019 X/Q	VKS 6183 VKS 6181	5)
19 T 4x2 FL, (Type F22)	<input checked="" type="radio"/>	V9-75 L	VKBA 5162		<input checked="" type="radio"/>	VKHB 2132 VKHB 2070	331933/Q 32310 J2/Q	VKS 6182	
	<input type="radio"/>	H9-13120	VKBA 5160		<input checked="" type="radio"/>	VKHB 2163 VKHB 2164	33022 30220 J2	VKS 6183 VKS 6181	





MAN .../...

○ HY-13110 VKBA 5163 ● VKHB 2146 33021/QVB091 VKS 6189
● VKHB 2082 33019/Q

19 T 4x2 F, (Type F21) ● V9-75 L VKBA 5162 ● VKHB 2132 331933/Q VKS 6182
● VKHB 2070 32310 J2/Q
○ H9-13120 VKBA 5160 ● VKHB 2163 33022 VKS 6183
● VKHB 2164 30220 J2 VKS 6181
○ HY-13110 VKBA 5163 ● VKHB 2146 33021/QVB091 VKS 6189
● VKHB 2082 33019/Q











22/24/25/26 T, 6x2 FN-LL, (Type F06) ● V9-75 L VKBA 5162 ● VKHB 2132 331933/Q VKS 6182
● VKHB 2070 32310 J2/Q
○ HN9-75 VKBA 5162 ● VKHB 2132 331933/Q VKS 6182
● VKHB 2070 32310 J2/Q
○ HY-13110 VKBA 5163 ● VKHB 2146 33021/QVB091 VKS 6189
● VKHB 2082 33019/Q
○ H9-13120 VKBA 5160 ● VKHB 2163 33022 VKS 6183
● VKHB 2164 30220 J2 VKS 6181

22/24/25/26 T, 6x2 FNL, (Type F25) ● V9-75 L VKBA 5162 ● VKHB 2132 331933/Q VKS 6182
● VKHB 2070 32310 J2/Q
○ HN9-75 VKBA 5162 ● VKHB 2132 331933/Q VKS 6182
● VKHB 2070 32310 J2/Q
○ H9-13120 VKBA 5160 ● VKHB 2163 33022 VKS 6183 5)
● VKHB 2164 30220 J2 VKS 6181
○ H9-13120 ● VKHB 2163 33022 VKS 6334 6)
● VKHB 2164 30220 J2
○ HY-13110 VKBA 5163 ● VKHB 2146 33021/QVB091 VKS 6189
● VKHB 2082 33019/Q

22/24/25/26 T, 6x2 UNL, (Type U15) ● V9-75 L VKBA 5162 ● VKHB 2132 331933/Q VKS 6182
● VKHB 2070 32310 J2/Q
○ HY-13110 VKBA 5163 ● VKHB 2146 33021/QVB091 VKS 6189
● VKHB 2082 33019/Q
○ H9-13120 VKBA 5160 ● VKHB 2163 33022 VKS 6183
● VKHB 2164 30220 J2 VKS 6181
○ HN9-75 VKBA 5162 ● VKHB 2132 331933/Q VKS 6182
● VKHB 2070 32310 J2/Q

22/24/25/26 T, 6x2/4 FVL, (Type F07) ● V9-75 L VKBA 5162 ● VKHB 2132 331933/Q VKS 6182
● VKHB 2070 32310 J2/Q
○ HY-13110 VKBA 5163 ● VKHB 2146 33021/QVB091 VKS 6189
● VKHB 2082 33019/Q
○ H9-13120 VKBA 5160 ● VKHB 2163 33022 VKS 6183
● VKHB 2164 30220 J2 VKS 6181

24 T 6x2 FNL, (Type M09) ● V7-80 L VKBA 5162 ● VKHB 2132 331933/Q VKS 6182
● VKHB 2070 32310 J2/Q
● V7-65 L ● VKHB 2293 BT1B 328286/Q VKS 6329
● VKHB 2004 32309 J2/Q

									
		<ul style="list-style-type: none"> ○ HY-1175 ○ H7-1080 ○ H7-1080 ○ HN7-67 ○ H9-1180 	VKBA 5163		<ul style="list-style-type: none"> ● VKHB 2146 ● VKHB 2082 ● VKHB 2146 ● VKHB 2161 ● VKHB 2146 ● VKHB 2161 ● VKHB 2293 ● VKHB 2004 ● VKHB 2146 ● VKHB 2161 	33021/QVB091 33019/Q 33021/QVB091 32019 X/Q 33021/QVB091 32019 X/Q BT1B 328286/Q 32309 J2/Q 33021/QVB091 32019 X/Q	VKS 6189 VKS 6334 VKS 6183 VKS 6181 VKS 6329 VKS 6334	6) 5)	
24 T, 6x2/4 FVL, (Type M10)	<ul style="list-style-type: none"> ● V7-80 L ○ H7-1080/1180 ○ HY-1175 ○ H9-1180 ○ H7-1080/1180 	VKBA 5162 VKBA 5163		<ul style="list-style-type: none"> ● VKHB 2132 ● VKHB 2070 ● VKHB 2146 ● VKHB 2161 ● VKHB 2146 ● VKHB 2082 ● VKHB 2146 ● VKHB 2161 ● VKHB 2146 ● VKHB 2161 	331933/Q 32310 J2/Q 33021/QVB091 32019 X/Q 33021/QVB091 33019/Q 33021/QVB091 32019 X/Q 33021/QVB091 32019 X/Q	VKS 6182 VKS 6334 VKS 6189 VKS 6334 VKS 6183 VKS 6181	6) 5)		
26 T, 4x2 FNLL, (Type F19)	<ul style="list-style-type: none"> ● V9-75 L ○ HY-13110 ○ H9-13120 ○ HN9-75 	VKBA 5162 VKBA 5163 VKBA 5160 VKBA 5162		<ul style="list-style-type: none"> ● VKHB 2132 ● VKHB 2070 ● VKHB 2146 ● VKHB 2082 ● VKHB 2163 ● VKHB 2164 ● VKHB 2132 ● VKHB 2070 	331933/Q 32310 J2/Q 33021/QVB091 33019/Q 33022 30220 J2 331933/Q 32310 J2/Q	VKS 6182 VKS 6189 VKS 6183 VKS 6181 VKS 6182			
26/27/28/30/32/33 T, 6x6 DFA, (Type F10)	<ul style="list-style-type: none"> ● VA9-0950 ○ H9-1080/1180 ○ H9-1080/1180 ○ HD9-16120 ○ HD9-1380 ○ HD9-1080/1180 ○ HD9-1380 ○ HD9-13120 ○ HD9-13120 	VKBA 5160 VKBA 5160 VKBA 5160		<ul style="list-style-type: none"> ● VKHB 2172 ● VKHB 2161 ● VKHB 2146 ● VKHB 2161 ● VKHB 2146 ● VKHB 2161 ● VKHB 2163 ● VKHB 2165 ● VKHB 2163 ● VKHB 2165 ● VKHB 2146 ● VKHB 2161 ● VKHB 2163 ● VKHB 2164 ● VKHB 2163 ● VKHB 2164 ● VKHB 2163 ● VKHB 2165 	331974 A/Q 32019 X/Q 33021/QVB091 32019 X/Q 33021/QVB091 32019 X/Q 33022 33220 33022 33220 33022 33220 33021/QVB091 32019 X/Q 33022 30220 J2 33022 30220 J2	VKS 6194 VKS 6334 VKS 6183 VKS 6181 VKS 6183 VKS 6181 VKS 6183 VKS 6181 VKS 6183 VKS 6181 VKS 6183 VKS 6181 VKS 6183 VKS 6181 VKS 6183 VKS 6181	6) 5) 8) 11) 9) 8)		
26/27/28/32/33 T, 6x4 DF, (Type F09)	<ul style="list-style-type: none"> ● V9-90 L 			<ul style="list-style-type: none"> ● VKHB 2172 ● VKHB 2161 	331974 A/Q 32019 X/Q	VKS 6194			





MAN .../...

	<ul style="list-style-type: none"> ● V9-75 L ○ HD7-1380 ○ HD9-1080/1180 ○ HD9-16120 ○ HD9-1380 ○ HD9-1380 ○ HD9-1380 ○ HD9-13120 ○ HD9-13120 	<p>VKBA 5162</p> <p>VKBA 5160</p> <p>VKBA 5160</p> <p>VKBA 5160</p>		<ul style="list-style-type: none"> ● VKHB 2132 ● VKHB 2070 ● VKHB 2163 ● VKHB 2164 ● VKHB 2146 ● VKHB 2161 ● VKHB 2163 ● VKHB 2165 ● VKHB 2163 ● VKHB 2164 ● VKHB 2163 ● VKHB 2164 ● VKHB 2163 ● VKHB 2165 ● VKHB 2163 ● VKHB 2164 ● VKHB 2163 ● VKHB 2165 	<p>331933/Q</p> <p>32310 J2/Q</p> <p>33022</p> <p>30220 J2</p> <p>33021/QVB091</p> <p>32019 X/Q</p> <p>33022</p> <p>33220</p> <p>33022</p> <p>30220 J2</p> <p>33022</p> <p>30220 J2</p> <p>33022</p> <p>33220</p> <p>33022</p> <p>30220 J2</p> <p>33022</p> <p>33220</p> <p>33022</p> <p>30220 J2</p> <p>33022</p> <p>33220</p>	<p>VKS 6182</p> <p>13)</p> <p>VKS 6183</p> <p>VKS 6181</p> <p>VKS 6183</p> <p>VKS 6181</p> <p>VKS 6183</p> <p>VKS 6181</p> <p>VKS 6183</p> <p>VKS 6181</p> <p>VKS 6183</p> <p>VKS 6181</p> <p>VKS 6183</p> <p>VKS 6181</p> <p>VKS 6183</p> <p>VKS 6181</p> <p>VKS 6183</p> <p>VKS 6181</p>	
32/35/41 T, 8x8/4-8x6/4, 8x4/4, (Type E15)	<ul style="list-style-type: none"> ● VA9-0950 ● V9-90 L ○ HD9-1080/1180 ○ HD9-1380 ○ HD9-1080/1180 ○ HD9-13120 ○ HD9-13120 ○ HD9-1380 	<p>VKBA 5160</p> <p>VKBA 5160</p>		<ul style="list-style-type: none"> ● VKHB 2172 ● VKHB 2161 ● VKHB 2172 ● VKHB 2161 ● VKHB 2146 ● VKHB 2161 ● VKHB 2163 ● VKHB 2164 ● VKHB 2146 ● VKHB 2161 ● VKHB 2163 ● VKHB 2164 ● VKHB 2163 ● VKHB 2164 ● VKHB 2163 ● VKHB 2164 	<p>331974 A/Q</p> <p>32019 X/Q</p> <p>331974 A/Q</p> <p>32019 X/Q</p> <p>33021/QVB091</p> <p>32019 X/Q</p> <p>33022</p> <p>30220 J2</p> <p>33021/QVB091</p> <p>32019 X/Q</p> <p>33022</p> <p>30220 J2</p> <p>33022</p> <p>30220 J2</p> <p>33022</p> <p>30220 J2</p> <p>33022</p> <p>30220 J2</p>	<p>VKS 6194</p> <p>VKS 6194</p> <p>VKS 6183</p> <p>VKS 6181</p> <p>VKS 6183</p> <p>VKS 6181</p> <p>VKS 6334</p> <p>VKS 6334</p> <p>VKS 6183</p> <p>VKS 6181</p> <p>VKS 6334</p> <p>VKS 6183</p> <p>VKS 6181</p>	<p>5)</p> <p>5)</p> <p>6)</p> <p>6)</p> <p>5)</p> <p>6)</p>
38/40 T, 6x6 DFA, (Type F12)	<ul style="list-style-type: none"> ● VA9-0950 ○ HD9-16120 			<ul style="list-style-type: none"> ● VKHB 2172 ● VKHB 2161 ● VKHB 2163 ● VKHB 2165 	<p>331974 A/Q</p> <p>32019 X/Q</p> <p>33022</p> <p>33220</p>	<p>VKS 6194</p> <p>VKS 6183</p> <p>VKS 6181</p>	
40 T 6x4 DF, (Type F11)	<ul style="list-style-type: none"> ● V9-90 L ○ HD9-16120 			<ul style="list-style-type: none"> ● VKHB 2172 ● VKHB 2161 ● VKHB 2163 ● VKHB 2165 	<p>331974 A/Q</p> <p>32019 X/Q</p> <p>33022</p> <p>33220</p>	<p>VKS 6194</p> <p>VKS 6183</p> <p>VKS 6181</p>	
41 T 8x8/4, 8x6/4 VFA, (Type E15)	<ul style="list-style-type: none"> ● V9-90 L ○ HD9-1380/H9-1380 	<p>VKBA 5160</p>		<ul style="list-style-type: none"> ● VKHB 2172 ● VKHB 2161 ● VKHB 2163 ● VKHB 2164 	<p>331974 A/Q</p> <p>32019 X/Q</p> <p>33022</p> <p>30220 J2</p>	<p>VKS 6194</p> <p>VKS 6183</p> <p>VKS 6181</p>	













	○	HD9-1080/ H9-1080			●	VKHB 2146 VKHB 2161	33021/QVB091 32019 X/Q	VKS 6183 VKS 6181	
	○	HD9-13120/ H9-13120	VKBA 5160		●	VKHB 2163 VKHB 2164	33022 30220 J2	VKS 6183 VKS 6181	
L, M, F 2000 Ser.	●	V9-32 L			●	VKHB 2179	33206/Q		14)
	●	V9-32 L			●	VKHB 2179	33206/Q		15)
	●	V9-34 L	VKBA 5265		●	VKHB 2240 VKHB 2018	BT1B 328251/Q 32207 J2/Q	VKS 6296	14)
	●	V9-34 L			●	VKHB 2240 VKHB 2018	BT1B 328251/Q 32207 J2/Q		15)
	●	V9-40 L	VKBA 5265		●	VKHB 2240 VKHB 2018	BT1B 328251/Q 32207 J2/Q	VKS 6296	14)
	●	V9-40 L			●	VKHB 2240 VKHB 2018	BT1B 328251/Q 32207 J2/Q		15)
	●	V9-42 L			●	VKHB 2240 VKHB 2018	BT1B 328251/Q 32207 J2/Q		15)
	●	V9-50 L, V9-60 L			●	VKHB 2293 VKHB 2067	BT1B 328286/Q 33209/Q	VKS 6329	16)
	●	V9-50 L, V9-60 L			●	VKHB 2293 VKHB 2067	BT1B 328286/Q 33209/Q		17)
	●	V9-50 L, V9-60 L			●	VKHB 2293 VKHB 2067	BT1B 328286/Q 33209/Q		18)
	●	V9-67 L			●	VKHB 2293 VKHB 2004	BT1B 328286/Q 32309 J2/Q	VKS 6329	
	●	V9-75 L, V9-80 L	VKBA 5162		●	VKHB 2132 VKHB 2070	331933/Q 32310 J2/Q	VKS 6182	
	●	V9-82 L	VKBA 5377		●				
	●	VA9-0540			●	VKHB 2169 VKHB 2282	32017 X/Q 32015 X/Q		
	●	VA9-0950			●	VKHB 2172 VKHB 2161	331974 A/Q 32019 X/Q	VKS 6194	
	○	HY-0645, HY-0745	VKBA 5150		●	VKHB 2174 VKHB 2175	547518 39590/39520/Q	VKS 6192	
	○	HY-0855			●	VKHB 2046	33015/Q		
	○	HY-0955, HY-1175			●	VKHB 2248 VKHB 2222	30218 J2 33115/Q	VKS 6328	
	○	HY-13110	VKBA 5163		●	VKHB 2146 VKHB 2082	33021/QVB091 33019/Q	VKS 6189	
	○	HN9-75	VKBA 5162		●	VKHB 2132 VKHB 2070	331933/Q 32310 J2/Q	VKS 6182	
	○	H9-0670			●	VKHB 2169 VKHB 2282	32017 X/Q 32015 X/Q		
	○	H9-1180			●	VKHB 2146 VKHB 2161	33021/QVB091 32019 X/Q	VKS 6334	
	○	H9-1380/13120	VKBA 5160		●	VKHB 2163 VKHB 2164	33022 30220 J2	VKS 6183 VKS 6181	





MAN .../...

	<ul style="list-style-type: none"> ○ HD9-1180 ○ HD9-1380/13120 ○ HD9-16120 	VKBA 5160		<ul style="list-style-type: none"> ● ● ● ● ● 	<ul style="list-style-type: none"> ● VKHB 2146 33021/QVB091 ● VKHB 2161 32019 X/Q ● VKHB 2163 33022 ● VKHB 2164 30220 J2 ● VKHB 2163 33022 ● VKHB 2165 33220 	<ul style="list-style-type: none"> VKS 6334 VKS 6183 VKS 6181 VKS 6183 VKS 6181
TGA 18 T 4x2 BLS-TS D28	<ul style="list-style-type: none"> ● VOK-08, RL VOK-08, RL VOK-09 ○ HY-1350 	VKBA 5377 VKBA 5408		<ul style="list-style-type: none"> ● ● ● 		
TGA 18 T 4x4 BB D28	<ul style="list-style-type: none"> ○ H9-13120 ○ HP-1652 			<ul style="list-style-type: none"> ● ● ● 	<ul style="list-style-type: none"> ● VKHB 2163 33022 ● VKHB 2164 30220 J2 ● VKHB 2163 33022 ● VKHB 2165 33220 	<ul style="list-style-type: none"> VKS 6334 VKS 6334
TGA 19 T 4x2 BBS-WW D28	<ul style="list-style-type: none"> ● - 	VKBA 5377		<ul style="list-style-type: none"> ● ● 		
TGA 24 T 6x2-2 LL-U D28	<ul style="list-style-type: none"> ● VOK-08, RL VOK-08 ○ HY-1350 ○ Trailing axle: NO-08 	VKBA 5377 VKBA 5408 VKBA 5377		<ul style="list-style-type: none"> ● ● ● ● ● 		
TGA 26 T 6x2-2, 6x2-4 BL D28	<ul style="list-style-type: none"> ● VOK-08, RL VOK-08 ○ HY-1350 ○ Trailing axle: NO-08, NOL-08, LO-08, LOL-08 	VKBA 5377 VKBA 5408 VKBA 5377		<ul style="list-style-type: none"> ● ● ● ● ● 		
TGA 26/33 T 6x4 BB D28	<ul style="list-style-type: none"> ● VOK-08, RL VOK-08, VO-09, RL VO-09 ○ HY-1350 ○ HYD-1370 ○ HP-1652 ○ H9-13120 	VKBA 5377 VKBA 5408 VKBA 5408 VKBA 5370		<ul style="list-style-type: none"> ● ● ● ● ● ● ● 	<ul style="list-style-type: none"> ● VKHB 2163 33022 ● VKHB 2165 33220 ● VKHB 2163 33022 	<ul style="list-style-type: none"> VKS 6334 VKS 6334 VKS 6334

									
		<input type="radio"/> HD9-16120 <input type="radio"/> H9-16120	VKBA 5370		<ul style="list-style-type: none"> • • • • 	VKHB 2164 30220 J2 VKHB 2163 33022 VKHB 2165 33220 VKHB 2163 33022 VKHB 2165 33220		VKS 6183 VKS 6334	
TGA 26/33 T 6x6 BB D20		<input type="radio"/> HD9-13120	VKBA 5160		<ul style="list-style-type: none"> • • 	VKHB 2163 33022 VKHB 2164 30220 J2		VKS 6183 VKS 6181	
TGA 28 T 6x2-4 BL/LL D28	•	<input type="radio"/> VOK-08, RL VOK-08 <input type="radio"/> HY-1350 <input type="radio"/> Trailing axle: NO-08, NOL-08	VKBA 5377 VKBA 5408 VKBA 5377		<ul style="list-style-type: none"> • • • • 				
TGA 32 T 8x4 BB D28	•	<input type="radio"/> V0-09, VOK-08, RL VOK-08 <input type="radio"/> HY-1350 <input type="radio"/> H9-13120	VKBA 5377 VKBA 5408		<ul style="list-style-type: none"> • • • • 	VKHB 2163 33022 VKHB 2164 30220 J2		VKS 6334	
TGA 33 T 6x2-2 BL D28	•	<input type="radio"/> VOK-08, RL VOK-08, V0-09, RL V0-09 <input type="radio"/> H9-13120	VKBA 5377		<ul style="list-style-type: none"> • • • 	VKHB 2163 33022 VKHB 2164 30220 J2		VKS 6334	
TGA 35 T 8x4 BB D28	•	<input type="radio"/> VOK-08, RL VOK-08 <input type="radio"/> HY-1350, HYD-1370 <input type="radio"/> H9-13120 <input type="radio"/> Trailing axle: NO-08, NOL-08	VKBA 5377 VKBA 5408 VKBA 5377		<ul style="list-style-type: none"> • • • • 	VKHB 2163 33022 VKHB 2164 30220 J2		VKS 6334	
TGA 40 T 6x6 BB-WW D28	•	<input type="radio"/> VOK-08, RL VOK-08 <input type="radio"/> H9-13120 <input type="radio"/> HP-1652	VKBA 5377 VKBA 5370		<ul style="list-style-type: none"> • • • • 	VKHB 2163 33022 VKHB 2164 30220 J2 VKHB 2163 33022 VKHB 2165 33220		VKS 6334 VKS 6334	















MAN .../...

TGA 35/41 T 8x6 BB D28	●	VOK-08, RL VOK-08	VKBA 5377	●			
	○	H9-13120		●	VKHB 2163 VKHB 2164	33022 30220 J2	VKS 6334
	○	HP-1652	VKBA 5370	●	VKHB 2163 VKHB 2165	33022 33220	VKS 6334
TGA 41 T 8x4/4 BB/BL D28	●	VOK-08, RL VOK-08	VKBA 5377	●			
	○	H9-13120		●	VKHB 2163 VKHB 2164	33022 30220 J2	VKS 6334
	○	HP-1652	VKBA 5370	●	VKHB 2163 VKHB 2165	33022 33220	VKS 6334
TGA 41/50 T 8x4 BB-WW D28	●	V0-09, VOK-09	VKBA 5377	●			
	○	HY-1350	VKBA 5408	●			
	○	H9-13120		●	VKHB 2163 VKHB 2164	33022 30220 J2	VKS 6334
	○	H9-16120	VKBA 5370	●	VKHB 2163 VKHB 2165	33022 33220	VKS 6334
	○	HP-1652	VKBA 5370	●	VKHB 2163 VKHB 2165	33022 33220	VKS 6334

MERCEDES-BENZ

100	●		VKBA 3404	●			1)
	○		VKBA 3426	●			12)
100, D,D (631.332, 333, 334, 340, 342, 343, 344)	○		VKBA 3405	●			2)
100 D (631.340)	○		VKBA 3405	●			15)
HENSCHEL 2-t, 207 1.8	●		VKBA 596	●			16)
	○		VKBA 1470	●			16)
SPRINTER 2-t	●		VKBA 3434	●			17)
	○		VKBA 3435	●			18)

									
SPRINTER 3-t	●		VKBA 3434		●				23)
		○	VKBA 3435		●				31)
SPRINTER 4-t	●		VKBA 3434		●				32)
		○	VKBA 3435		●				33)
V-CLASS	●		VKBA 3486		●				34)
		○	VKBA 3486		●				34)
VITO, 113 2.0 (638.014), 108 CDI 2.2, 112 CDI 2.2, 108 D 2.3 (638.064), 110 D 2.3 (638.074) 110 TD 2.3 (638.174), 114 2.3 (638.034.134)	●		VKBA 3486		●				35)
		○	VKBA 3486		●				35)
T1, 207 D, 208, 208 D, 209 D, 210, 210 D, 212, 214, 215	●	VL 0/1 C-1.3, VL 0/2 C-1.5	VKBA 596		●				
	●	VL 0/6 CE-1.6, VL 0/7 CE-1.6	VKBA 3434		●				
	○	HL 0/1-1.7, HL 0/2-2.2	VKBA 1470		●				
T1, 307 D, 308, 308 D, 309, 309 D, 310, 310 D, 312, 314, 315	●	VL 0/11 CE-1.75	VKBA 3434		●				
T1, 307 D, 308, 308 D, 309, 309 D, 310, 310 D, 312, 314, 315	●	VL 0/2 C-1.5	VKBA 596		●				
T1, 307 D, 308, 308 D, 309, 309 D, 310, 310 D, 312, 314, 315	●	VL 0/3 C-1.7, VL 0/7 CE-1.6	VKBA 3434		●				
	●	VL 1/3-2.1			●	VKHB 2054	2789/2720/ QCL7C		4)
	●	VL 1/3-2.1	VKBA 5025		●	VKHB 2055	1380/1328/Q		
	○	HL 0/2-2.2	VKBA 1470		●	VKHB 2056 VKHB 2057	33109/Q 33205/QVQ077	VKS 6299	5)
T1, 406, 406 D, 407, 407D, 408, 408 D, 408 G, 409, 409D, 410, 410 D, 412, 414, 415	●	VL 0/12 CE-1.75	VKBA 3434		●				
	●	VL 0/2 C-1.5	VKBA 596		●				





MERCEDES-BENZ

.../...

●	VL 0/3 C-1.7, VL 0/8 CE-1.75	VKBA 3434	●			
●	VL 1/3-2.1		●	VKHB 2054	2789/2720/ QCL7C	4)
●	VL 1/3-2.1	VKBA 5025	●	VKHB 2055	1380/1328/Q	
●	VL 1/4-1.6		●	VKHB 2056	33109/Q	VKS 6299 5)
●	VL 1/4-1.6		●	VKHB 2057	33205/QVQ077	
●	VL 1/4-1.6		●	VKHB 2058	32304 J2/Q	6)
●	VL 1/4-1.6		●	VKHB 2018	32207 J2/Q	
●	VL 1/4-1.6	VKBA 5025	●	VKHB 2054	2789/2720/ QCL7C	7)
●	VL 1/4-1.6		●	VKHB 2055	1380/1328/Q	
○	HL 0/3-3.3		●	VKHB 2056	33109/Q	VKS 6299 8)
○	HL 1/2-3.3		●	VKHB 2057	33205/QVQ077	
			●	VKHB 2060	32011 X/Q	VKS 6159
			●	VKHB 2017	32210 J2/Q	
			●	VKHB 2019	32211 J2/Q	VKS 6143 9)
			●	VKHB 2017	32210 J2/Q	

T1, 500 Ser.	●	VL 0/5 C-1.7, VL 0/9 DC-1.8	VKBA 3434	●		
	●	VL 1/3-2.1		●	VKHB 2054	2789/2720/ QCL7C
	●	VL 1/3-2.1	VKBA 5025	●	VKHB 2055	1380/1328/Q
	●	VL 1/3-2.1		●	VKHB 2056	33109/Q
	●	VL 1/6-2.3, VL 1/7-2.6, VL 1/9 C-2.3	VKBA 5025	●	VKHB 2057	33205/QVQ077
	○	HL 0/6-3.9		●	VKHB 2056	33109/Q
	○	HL 0/7-3.2		●	VKHB 2057	33205/QVQ077
	○	HL 1/2-3.3		●	VKHB 2234	32012 X/QCL7C
	○	HL 1/3-4.5, HL 2/5-4.5, HL 2/9-4.7		●	VKHB 2017	32210 J2/Q
				●	VKHB 2060	32011 X/Q
				●	VKHB 2017	32210 J2/Q
				●	VKHB 2019	32211 J2/Q
				●	VKHB 2017	32210 J2/Q
				●	VKHB 2075	33895/33822/Q

T2, 600 Ser.	●	VL 1/3-2.1		●	VKHB 2054	2789/2720/ QCL7C
	●	VL 1/3-2.1	VKBA 5025	●	VKHB 2055	1380/1328/Q
	●	VL 1/3-2.1		●	VKHB 2056	33109/Q
	●	VL 1/5-2.3, VL 1/ 6-2.3, VL 1/7-2.6, VL 1/9 C-2.3	VKBA 5025	●	VKHB 2057	33205/QVQ077
				●	VKHB 2056	33109/Q
				●	VKHB 2057	33205/QVQ077



	<ul style="list-style-type: none"> ● VL 2/5-2.2 ● VL 2/6-3.1 ○ HL 0/6-3.9 ○ HL 1/3-4.5 ○ HL 1/8-4.7 ○ HL 2/15-5.8 ○ HL 2/2 L-4.8, HL 2/2-4.8, HL 2/5-4.5, HL 2/9-4.7 	VKBA 5026		<ul style="list-style-type: none"> ● VKHB 2060 32011 X/Q ● VKHB 2016 32206 J2/Q ● VKHB 2059 33111/Q ● VKHB 2007 32306 J2/Q ● VKHB 2234 32012 X/QCL7C ● VKHB 2017 32210 J2/Q ● VKHB 2075 33895/33822/Q ● VKHB 2154 32014 X/Q ● VKHB 2060 32011 X/Q ● VKHB 2155 331293/Q ● VKHB 2156 33011/Q ● VKHB 2075 33895/33822/Q 	VKS 6159
LK, 700 Ser.	<ul style="list-style-type: none"> ● VL 1/10 C-2.5, VL 1/8 D-2.5, VL 1/9 C-2.3 ● VL 2/5-2.2 ○ HL 1/8-4.7 ○ HL 1/9-5.6 ○ HL 2/12 D-4.5 ○ HL 2/13 D-6.4 ○ HL 2/15-5.8 ○ HL 2/2 L-4.8, HL 2/2-4.8 	VKBA 5025	VKA 4103	<ul style="list-style-type: none"> ● VKHB 2056 33109/Q ● VKHB 2057 33205/QVQ077 ● VKHB 2060 32011 X/Q ● VKHB 2016 32206 J2/Q ● VKHB 2154 32014 X/Q ● VKHB 2060 32011 X/Q ● VKHB 2155 331293/Q ● VKHB 2156 33011/Q ● VKHB 2154 32014 X/Q ● VKHB 2060 32011 X/Q ● VKHB 2137 JM 714249/210/Q ● VKHB 2233 33112/QVB259 ● VKHB 2155 331293/Q ● VKHB 2156 33011/Q ● VKHB 2075 33895/33822/Q 	VKS 6299
LK, 800 Ser.	<ul style="list-style-type: none"> ● VL 1/10 C-2.5 ● VL 2/10 D-3.5 ● VL 2/12 D-3.8 ● VL 2/4-3.4, VL 2/6-3.1 ● VL 2/8-3.2 ● VL 2/9 D-3.1 ● VL 3/11 D-4.4 	VKBA 5025	VKBA 5028	<ul style="list-style-type: none"> ● VKHB 2056 33109/Q ● VKHB 2057 33205/QVQ077 ● VKHB 2061 33211/Q ● VKHB 2007 32306 J2/Q ● VKHB 2061 33211/Q ● VKHB 2064 529656 ● VKHB 2059 33111/Q ● VKHB 2007 32306 J2/Q ● VKHB 2061 33211/Q ● VKHB 2007 32306 J2/Q ● VKHB 2059 33111/Q ● VKHB 2007 32306 J2/Q ● VKHB 2051 33213/Q ● VKHB 2065 33208/Q 	VKS 6148





MERCEDES-BENZ .../...

○ HL 1/9-5.6, HL 2/11 D-5.8	VKBA 5048	VKA 4103	● VKHB 2155 331293/Q ● VKHB 2156 33011/Q	VKS 6172
○ HL 2/12 D-4.5			● VKHB 2154 32014 X/Q ● VKHB 2060 32011 X/Q	VKS 6173
○ HL 2/13 D-6.4			● VKHB 2137 JM 714249/ 210/Q ● VKHB 2233 33112/QVB259	VKS 6174
○ HL 2/15 S-5.8, HL 2/15-5.8	VKBA 5048	VKA 4103	● VKHB 2155 331293/Q ● VKHB 2156 33011/Q	VKS 6172
○ HL 2/3-5.7			● VKHB 2076 47490/47420 ● VKHB 2059 33111/Q	
○ HL 2/4 L-6.4, HL 2/4-6.4			● VKHB 2137 JM 714249/ 210/Q ● VKHB 2233 33112/QVB259	
○ HL 4/1-7.6			● VKHB 2026 32216 J2/Q ● VKHB 2079 330356 A/Q	
○ HL 4/23-7.7, HL 4/28 D-7.8			● VKHB 2041 580/572/Q ● VKHB 2079 330356 A/Q	VKS 6178
○ HL 4/29 D-9.2			● VKHB 2158 33117/Q ● VKHB 2081 331074/Q	VKS 6178
○ HL 4/30 DS-6.4, HL 4/30 D-6.4, HL 4/35 D-6.4			● VKHB 2157 32016 X/Q ● VKHB 2159 33113/QVB022	VKS 6175
○ HL 4/4-8.8			● VKHB 2080 32217 J2/Q ● VKHB 2081 331074/Q	VKS 6151

LK, 900 Ser.

● VL 2/10 D-3.5	VKBA 5028		● VKHB 2061 33211/Q ● VKHB 2007 32306 J2/Q	VKS 6148
● VL 2/11 D-3.8, VL 2/12 D-3.8, VL 2/12 D-3.8			● VKHB 2061 33211/Q ● VKHB 2064 529656	VKS 6148
● VL 2/4-3.4, VL 2/6-3.1	VKBA 5026		● VKHB 2059 33111/Q ● VKHB 2007 32306 J2/Q	VKS 6159
● VL 3/11 D-4.4			● VKHB 2051 33213/Q ● VKHB 2065 33208/Q	VKS 6157
● VL 3/1-3.8			● VKHB 2064 529656	VKS 6157
○ HL 2/13 D-6.4			● VKHB 2137 JM 714249/ 210/Q ● VKHB 2233 33112/QVB259	VKS 6174
○ HL 2/4 L-6.4, HL 2/4-6.4			● VKHB 2137 JM 714249/ 210/Q ● VKHB 2233 33112/QVB259	
○ HL 4/1-7.6			● VKHB 2026 32216 J2/Q ● VKHB 2079 330356 A/Q	



	<ul style="list-style-type: none"> ○ HL 4/23 L-7.7, HL 4/23-7.7, HL 4/28 D-7.8 ○ HL 4/29 D-9.2 ○ HL 4/30 DS-6.4, HL 4/30 D-6.4 ○ HL 4/31 DS-7.0 ○ HL 4/35 D-6.4 ○ HL 4/4-8.8 				<ul style="list-style-type: none"> ● VKHB 2041 580/572/Q VKHB 2079 330356 A/Q ● VKHB 2158 33117/Q VKHB 2081 331074/Q ● VKHB 2157 32016 X/Q VKHB 2159 33113/QVB022 ● VKHB 2158 33117/Q VKHB 2081 331074/Q ● VKHB 2157 32016 X/Q VKHB 2159 33113/QVB022 ● VKHB 2080 32217 J2/Q VKHB 2081 331074/Q 	<ul style="list-style-type: none"> VKS 6178 VKS 6178 VKS 6175 VKS 6178 VKS 6175 VKS 6151
LK, 1000 Ser.	<ul style="list-style-type: none"> ● VL 2/6-3.1 ● VL 2/7-3.6 ● VL 3/1-3.8, VL 3/4-5 ● VL 3/6-4.1, VL 3/7-5 ○ HL 2/4 L-6.4 ○ HL 2/7-7.7 ○ HL 4/01 L-10, HL 4/01-10 ○ HL 4/16 L-7.7, HL 4/16-7.7 ○ HL 4/17 L-9.2, HL 4/17 S-9.2, HL 4/17-9.2 ○ HL 4/1-7.6 ○ HL 4/23 L-7.7, HL 4/23-7.7 ○ HL 4/4-8.8 ○ HL 4/8 L-10, HL 4/8-6.3 ○ HL 7/1 S-10 ○ HL 7/1 S-10 ○ HL 7/1-10 	<ul style="list-style-type: none"> VKBA 5026 VKBA 5028 VKBA 5056 VKBA 5052 	VKA 4110	<ul style="list-style-type: none"> ● VKHB 2059 33111/Q VKHB 2007 32306 J2/Q ● VKHB 2061 33211/Q VKHB 2007 32306 J2/Q ● VKHB 2064 529656 ● VKHB 2051 33213/Q VKHB 2065 33208/Q ● VKHB 2137 JM 714249/ 210/Q ● VKHB 2233 33112/QVB259 ● VKHB 2041 580/572/Q VKHB 2079 330356 A/Q ● VKHB 2124 33020/Q VKHB 2158 33117/Q ● VKHB 2041 580/572/Q VKHB 2079 330356 A/Q ● VKHB 2080 32217 J2/Q VKHB 2081 331074/Q ● VKHB 2026 32216 J2/Q VKHB 2079 330356 A/Q ● VKHB 2041 580/572/Q VKHB 2079 330356 A/Q ● VKHB 2080 32217 J2/Q VKHB 2081 331074/Q ● VKHB 2082 33019/Q VKHB 2028 33215/Q ● VKHB 2162 33021/Q VKHB 2161 32019 X/Q ● VKHB 2146 33021/QVB091 VKHB 2161 32019 X/Q ● VKHB 2162 33021/Q VKHB 2161 32019 X/Q 	<ul style="list-style-type: none"> VKS 6159 VKS 6148 VKS 6157 VKS 6157 VKS 6178 VKS 6178 VKS 6176 VKS 6178 VKS 6151 VKS 6178 VKS 6151 VKS 6178 VKS 6151 VKS 6154 VKS 6183 25) VKS 6181 VKS 6334 26) VKS 6183 25) VKS 6181 	





MERCEDES-BENZ .../...

	○	HL 7/1-10			●	VKHB 2146 VKHB 2161	33021/QVB091 32019 X/Q	VKS 6334	26)
LK, 1100 Ser.	●	VL 2/11 D-3.8			●	VKHB 2061 VKHB 2064	33211/Q 529656	VKS 6148	
	●	VL 2/8-3.2	VKBA 5028		●	VKHB 2061 VKHB 2007	33211/Q 32306 J2/Q	VKS 6148	
	●	VL 3/11 D-4.4			●	VKHB 2051 VKHB 2065	33213/Q 33208/Q	VKS 6157	
	●	VL 3/13 D-5.3			●	VKHB 2066 VKHB 2067	33214/Q 33209/Q	VKS 6175	
	●	VL 3/1-3.8, VL 3/4.5			●	VKHB 2064	529656	VKS 6157	
	○	HL 4/05 D-9.2, HL 4/09 D-9.2			●	VKHB 2082 VKHB 2028	33019/Q 33215/Q		
	○	HL 4/1-7.6			●	VKHB 2026 VKHB 2079	32216 J2/Q 330356 A/Q		
	○	HL 4/23 L-7.7, HL 4/23-7.7, HL 4/28 D-7.8			●	VKHB 2041 VKHB 2079	580/572/Q 330356 A/Q	VKS 6178	
	○	HL 4/29 D-9.2, HL 4/31 DS-7.0			●	VKHB 2158 VKHB 2081	33117/Q 331074/Q	VKS 6178	
	○	HL 4/4-8.8			●	VKHB 2080 VKHB 2081	32217 J2/Q 331074/Q	VKS 6151	
	○	HL 5/2 S-6.5	VKBA 5052		●	VKHB 2082 VKHB 2028	33019/Q 33215/Q	VKS 6154	
LK, 1200 Ser.	●	VL 3/6 D-4.1, VL 3/6-4.1, VL 3/ 7 D-5, VL 3/7-5			●	VKHB 2051 VKHB 2065	33213/Q 33208/Q	VKS 6157	
	●	VL 3/8.6			●	VKHB 2066 VKHB 2067	33214/Q 33209/Q	VKS 6175	10)
	●	VL 3/8.6			●	VKHB 2066 VKHB 2068	33214/Q 33210/Q	VKS 6175	11)
	●	VL 4/3.6			●	VKHB 2066 VKHB 2067	33214/Q 33209/Q	VKS 6175	
	○	HL 4/01 DL-10, HL 4/01 D-10, HL 4/01 L-10, HL 4/01-10, HL 4/038 D-10, HL 4/038 D-9.4, HL 4/039 D-10, HL 4/07 D-9.4	VKBA 5056	VKA 4110	●	VKHB 2124 VKHB 2158	33020/Q 33117/Q	VKS 6176	
	○	HL 4/16 L-7.7, HL 4/16-7.7			●	VKHB 2041 VKHB 2079	580/572/Q 330356 A/Q	VKS 6178	



	○	HL 4/17 D-9.2, HL 4/17 L-9.2, HL 4/17-9.2			●	VKHB 2080 VKHB 2081	32217 J2/Q 331074/Q	VKS 6151	
	○	HL 4/29 D-9.2			●	VKHB 2158 VKHB 2081	33117/Q 331074/Q	VKS 6178	
	○	HL 4/4-8.8			●	VKHB 2080 VKHB 2081	32217 J2/Q 331074/Q	VKS 6151	
	○	HL 4/8 L-10, HL 4/8.1	VKBA 5052		●	VKHB 2082 VKHB 2028	33019/Q 33215/Q	VKS 6154	
	○	HL 5/1 Z-10			●	VKHB 2083	CK-598 A/ K-592 A		
	○	HL 7/024 D-12.3			●	VKHB 2033	32215 J2/Q		
	○	HL 7/1 D-10			●	VKHB 2162 VKHB 2082	33021/Q 33019/Q	VKS 6183 VKS 6181	
	○	HL 7/1 D-10			●	VKHB 2162 VKHB 2161	33021/Q 32019 X/Q	VKS 6183 VKS 6181	25)
	○	HL 7/1 D-10			●	VKHB 2146 VKHB 2161	33021/QVB091 32019 X/Q	VKS 6334	26)
	○	HL 7/1 L-10			●	VKHB 2162 VKHB 2161	33021/Q 32019 X/Q	VKS 6183 VKS 6181	25)
	○	HL 7/1 L-10			●	VKHB 2146 VKHB 2161	33021/QVB091 32019 X/Q	VKS 6334	26)
	○	HL 7/1 S-10			●	VKHB 2162 VKHB 2161	33021/Q 32019 X/Q	VKS 6183 VKS 6181	25)
	○	HL 7/1 S-10			●	VKHB 2146 VKHB 2161	33021/QVB091 32019 X/Q	VKS 6334	26)
	○	HL 7/18 D-13			●	VKHB 2163 VKHB 2164	33022 30220 J2	VKS 6183 VKS 6181	25)
	○	HL 7/18 D-13			●	VKHB 2163 VKHB 2164	33022 30220 J2	VKS 6334	26)
	○	HL 7/1-10			●	VKHB 2162 VKHB 2161	33021/Q 32019 X/Q	VKS 6183 VKS 6181	25)
	○	HL 7/1-10			●	VKHB 2146 VKHB 2161	33021/QVB091 32019 X/Q	VKS 6334	26)
	○	HL 7/26 DL-12.3			●	VKHB 2162 VKHB 2082	33021/Q 33019/Q	VKS 6183 VKS 6181	
LK, 1300 Ser.	●	AL 7/1 D-7			●	VKHB 2172 VKHB 2161	331974 A/Q 32019 X/Q	VKS 6194	
	●	VL 2/10 D-3.5	VKBA 5028		●	VKHB 2061 VKHB 2007	33211/Q 32306 J2/Q	VKS 6148	
	●	VL 2/12 D-3.8			●	VKHB 2061 VKHB 2064	33211/Q 529656	VKS 6148	
	●	VL 3/11 D-4.4, VL 3/12 D-5.3			●	VKHB 2051 VKHB 2065	33213/Q 33208/Q	VKS 6157	
	●	VL 3/13 D-5.3			●	VKHB 2066 VKHB 2067	33214/Q 33209/Q	VKS 6175	
	●	VL 3/4-5			●	VKHB 2064	529656	VKS 6157	
	●	VL 4/23 D-6.7	VKBA 5038	VKA 4094	●	VKHB 2071 VKHB 2070	332330 B/Q 32310 J2/Q	VKS 6158 VKS 6146	



MERCEDES-BENZ

.../...

	<ul style="list-style-type: none"> ● VL 4/3-6 ○ HL 1/8-4.7 ○ HL 4/05 D-9.2 ○ HL 4/29 D-9.2 ○ HL 4/32 D-10.6 ○ HL 4/4-8.8 ○ HL 4/8-10 ○ HL 5/1 Z-10 	VKBA 5052		<ul style="list-style-type: none"> ● VKHB 2066 33214/Q ● VKHB 2067 33209/Q ● VKHB 2154 32014 X/Q ● VKHB 2060 32011 X/Q ● VKHB 2082 33019/Q ● VKHB 2028 33215/Q ● VKHB 2158 33117/Q ● VKHB 2081 331074/Q ● VKHB 2082 33019/Q ● VKHB 2028 33215/Q ● VKHB 2080 32217 J2/Q ● VKHB 2081 331074/Q ● VKHB 2082 33019/Q ● VKHB 2028 33215/Q ● VKHB 2083 CK-598 A/ K-592 A ● VKHB 2033 32215 J2/Q 	<ul style="list-style-type: none"> VKS 6175 VKS 6173 VKS 6178 VKS 6151 VKS 6154
LK, 1400 Ser.	<ul style="list-style-type: none"> ● VL 3/15 D-6.5 ● VL 3/7 D-5, VL 3/7.5 ● VL 3/8 D-6.5 ● VL 3/8-6 ● VL 3/8-6 ● VL 4/10 DL-7 ● VL 4/10 D-7, VL 4/24 D-6.7, VL 4/25 DL-6.7, VL 4/25 DL-7.1 ● VL 4/29 D-7.5, VL 4/30 DL-7.5 ● VL 4/36 D-6.7, VL 4/36 D-7.1 ● VL 4/3-6 ○ HH 4/19 D-10 ○ HL 4/01 DL-10, HL 4/01 D-10, HL 4/01 L-10, HL 4/01-10, HL 4/038 D-10, HL 4/039 D-10 	VKBA 5038 VKBA 5039 VKBA 5038	VKA 4094 VKA 4094	<ul style="list-style-type: none"> ● VKHB 2066 33214/Q ● VKHB 2068 33210/Q ● VKHB 2051 33213/Q ● VKHB 2065 33208/Q ● VKHB 2066 33214/Q ● VKHB 2068 33210/Q ● VKHB 2066 33214/Q ● VKHB 2067 33209/Q ● VKHB 2066 33214/Q ● VKHB 2068 33210/Q ● VKHB 2071 332330 B/Q ● VKHB 2068 33210/Q ● VKHB 2071 332330 B/Q ● VKHB 2070 32310 J2/Q ● VKHB 2072 32314 J2/Q ● VKHB 2070 32310 J2/Q ● VKHB 2071 332330 B/Q ● VKHB 2070 32310 J2/Q ● VKHB 2066 33214/Q ● VKHB 2067 33209/Q ● VKHB 2082 33019/Q ● VKHB 2028 33215/Q ● VKHB 2124 33020/Q ● VKHB 2158 33117/Q 	<ul style="list-style-type: none"> VKS 6175 VKS 6157 VKS 6175 VKS 6175 10) VKS 6175 11) VKS 6158 VKS 6146 VKS 6158 VKS 6146 VKS 6150 VKS 6158 VKS 6146 VKS 6175 VKS 6154 VKS 6176



	○	HL 4/17 D-9.2, HL 4/17-9.2	VKBA 5052		●	VKHB 2080 VKHB 2081	32217 J2/Q 331074/Q	VKS 6151			
	○	HL 4/8 D-10, HL 4/8-10, HL 5/ 2 Z-10, HL 5/2-10			●	VKHB 2082 VKHB 2028	33019/Q 33215/Q	VKS 6154			
	○	HL 7/021 DL-10			●	VKHB 2162 VKHB 2161	33021/Q 32019 X/Q	VKS 6183 VKS 6181	25)		
	○	HL 7/021 DL-10			●	VKHB 2146 VKHB 2161	33021/QVB091 32019 X/Q	VKS 6334	26)		
	○	HL 7/021 D-10			●	VKHB 2162 VKHB 2161	33021/Q 32019 X/Q	VKS 6183 VKS 6181	25)		
	○	HL 7/021 D-10			●	VKHB 2146 VKHB 2161	33021/QVB091 32019 X/Q	VKS 6334	26)		
	○	HL 7/ 024 DL- 12.3, HL 7/024 D-12.3			●	VKHB 2162 VKHB 2082	33021/Q 33019/Q	VKS 6183 VKS 6181			
	○	HL 7/1 DL-10			●	VKHB 2162 VKHB 2161	33021/Q 32019 X/Q	VKS 6183 VKS 6181	25)		
	○	HL 7/1 DL-10			●	VKHB 2146 VKHB 2161	33021/QVB091 32019 X/Q	VKS 6334	26)		
	○	HL 7/1 D-10			●	VKHB 2162 VKHB 2161	33021/Q 32019 X/Q	VKS 6183 VKS 6181	25)		
	○	HL 7/1 D-10			●	VKHB 2146 VKHB 2161	33021/QVB091 32019 X/Q	VKS 6334	26)		
	○	HL 7/1 L-10			●	VKHB 2162 VKHB 2161	33021/Q 32019 X/Q	VKS 6183 VKS 6181	25)		
	○	HL 7/1 L-10			●	VKHB 2146 VKHB 2161	33021/QVB091 32019 X/Q	VKS 6334	26)		
	○	HL 7/1-10			●	VKHB 2162 VKHB 2161	33021/Q 32019 X/Q	VKS 6183 VKS 6181	25)		
	○	HL 7/1-10			●	VKHB 2146 VKHB 2161	33021/QVB091 32019 X/Q	VKS 6334	26)		
	○	NS 4/10 D-6.7			●	VKHB 2071 VKHB 2068	332330 B/Q 33210/Q	VKS 6158 VKS 6146			
LK, 1500 Ser.	●	VL 3/13 D-5.3		VKBA 5056	VKA 4110	●	VKHB 2066 VKHB 2067	33214/Q 33209/Q	VKS 6175		
	●	VL 3/15 D-6.5					●	VKHB 2066 VKHB 2068	33214/Q 33210/Q	VKS 6175	
	●	VL 3/4-5					●	VKHB 2064	529656	VKS 6157	
	●	VL 4/3-6					●	VKHB 2066 VKHB 2067	33214/Q 33209/Q	VKS 6175	
	○	HL 4/035 D-10.6, HL 4/06 D-12				●	VKHB 2124 VKHB 2158	33020/Q 33117/Q	VKS 6176		
	○	HL 4/32 D-10.6				●	VKHB 2082 VKHB 2028	33019/Q 33215/Q			





MERCEDES-BENZ .../...

○ HL 4/8-10, HL 5/2 S-10, HL 5/2 ZS-10, HL 5/2-10

VKBA 5052

● ●

VKHB 2082
VKHB 2028

33019/Q
33215/Q

VKS 6154

SK, 1600 Ser.

●	AL 7/1 D-7			●	VKHB 2172 VKHB 2161	331974 A/Q 32019 X/Q	VKS 6194
●	VD 4/14 DL-7	VKBA 5038	VKA 4094	●	VKHB 2071 VKHB 2070	332330 B/Q 32310 J2/Q	VKS 6158 VKS 6146
●	VD 4/20 DL-7.5			●	VKHB 2071 VKHB 2068	332330 B/Q 33210/Q	VKS 6158 VKS 6146
●	VD 4/20 DL-7.5	VKBA 5039		●	VKHB 2072 VKHB 2070	32314 J2/Q 32310 J2/Q	VKS 6150
●	VL 3/8 D-6.5			●	VKHB 2066 VKHB 2068	33214/Q 33210/Q	VKS 6175
●	VL 3/8-6			●	VKHB 2066 VKHB 2067	33214/Q 33209/Q	VKS 6175 10)
●	VL 3/8-6			●	VKHB 2066 VKHB 2068	33214/Q 33210/Q	VKS 6175 11)
●	VL 4/10 DL-7, VL 4/10 D-7			●	VKHB 2071 VKHB 2068	332330 B/Q 33210/Q	VKS 6158 VKS 6146
●	VL 4/10 D-7	VKBA 5038	VKA 4094	●	VKHB 2071 VKHB 2070	332330 B/Q 32310 J2/Q	VKS 6158 VKS 6146
●	VL 4/15 D-7.5, VL 4/16 D-7.5, VL 4/19 D-7.5	VKBA 5039		●	VKHB 2072 VKHB 2070	32314 J2/Q 32310 J2/Q	VKS 6150
●	VL 4/2 D-7			●	VKHB 2070	32310 J2/Q	
●	VL 4/30 DL-7.5	VKBA 5039		●	VKHB 2072 VKHB 2070	32314 J2/Q 32310 J2/Q	VKS 6150
●	VL 4/7 D-7			●	VKHB 2071 VKHB 2068	332330 B/Q 33210/Q	VKS 6158 13) VKS 6146
●	VL 4/7 D-7			●	VKHB 2071 VKHB 2068	332330 B/Q 33210/Q	VKS 6158 28) VKS 6146
●	VL 4/7 D-7	VKBA 5038	VKA 4094	●	VKHB 2071 VKHB 2070	332330 B/Q 32310 J2/Q	VKS 6158 VKS 6146
●	VL 4/7 D-7	VKBA 5038	VKA 4094	●	VKHB 2071 VKHB 2070	332330 B/Q 32310 J2/Q	VKS 6158 14) VKS 6146
●	VL 4/7 D-7	VKBA 5038	VKA 4094	●	VKHB 2071 VKHB 2070	332330 B/Q 32310 J2/Q	VKS 6158 27) VKS 6146
●	VL 4/8 D-7			●	VKHB 2071 VKHB 2068	332330 B/Q 33210/Q	VKS 6158 VKS 6146
●	VL 4/9 D-7			●	VKHB 2071 VKHB 2068	332330 B/Q 33210/Q	VKS 6158 13) VKS 6146
●	VL 4/9 D-7	VKBA 5038	VKA 4094	●	VKHB 2071 VKHB 2070	332330 B/Q 32310 J2/Q	VKS 6158 VKS 6146
●	VL 4/9 D-7	VKBA 5038	VKA 4094	●	VKHB 2071 VKHB 2070	332330 B/Q 32310 J2/Q	VKS 6158 14) VKS 6146
●	VO 4/18 DL-7	VKBA 5038	VKA 4094	●	VKHB 2071 VKHB 2070	332330 B/Q 32310 J2/Q	VKS 6158 VKS 6146



○ HD 7/2 DLG-10			● VKHB 2162 33021/Q	VKS 6183 25)
			● VKHB 2161 32019 X/Q	VKS 6181
○ HD 7/2 DLG-10			● VKHB 2146 33021/QVB091	VKS 6334 26)
			● VKHB 2161 32019 X/Q	
○ HH 4/04 D-12, HL 4/01 DL-10, HL 4/01 D-10, HL 4/01 L-10, HL 4/01-10, HL 4/06 DL-12, HL 4/06 D-12	VKBA 5056	VKA 4110	● VKHB 2124 33020/Q	VKS 6176
			● VKHB 2158 33117/Q	
○ HL 4/8 D-10, HL 4/8 L-10, HL 4/8-10, HL 5/ 2 ZL-10, HL 5/ 2 Z-10, HL 5/2-10	VKBA 5052		● VKHB 2082 33019/Q	VKS 6154
			● VKHB 2028 33215/Q	
○ HL 7/013 D-16			● VKHB 2163 33022	VKS 6183
			● VKHB 2165 33220	VKS 6181
○ HL 7/015 DL-13			● VKHB 2163 33022	VKS 6183 25)
			● VKHB 2164 30220 J2	VKS 6181
○ HL 7/015 DL-13			● VKHB 2163 33022	VKS 6334 26)
			● VKHB 2164 30220 J2	
○ HL 7/015 DS-13			● VKHB 2163 33022	VKS 6183 25)
			● VKHB 2164 30220 J2	VKS 6181
○ HL 7/015 DS-13			● VKHB 2163 33022	VKS 6334 26)
			● VKHB 2164 30220 J2	
○ HL 7/015 D-13			● VKHB 2163 33022	VKS 6183 25)
			● VKHB 2164 30220 J2	VKS 6181
○ HL 7/015 D-13			● VKHB 2163 33022	VKS 6334 26)
			● VKHB 2164 30220 J2	
○ HL 7/02 DL-10			● VKHB 2162 33021/Q	VKS 6183 25)
			● VKHB 2161 32019 X/Q	VKS 6181
○ HL 7/02 DL-10			● VKHB 2146 33021/QVB091	VKS 6334 26)
			● VKHB 2161 32019 X/Q	
○ HL 7/021 DL-10			● VKHB 2162 33021/Q	VKS 6183 25)
			● VKHB 2161 32019 X/Q	VKS 6181
○ HL 7/021 DL-10			● VKHB 2146 33021/QVB091	VKS 6334 26)
			● VKHB 2161 32019 X/Q	
○ HL 7/021 D-10			● VKHB 2162 33021/Q	VKS 6183 25)
			● VKHB 2161 32019 X/Q	VKS 6181
○ HL 7/021 D-10			● VKHB 2146 33021/QVB091	VKS 6334 26)
			● VKHB 2161 32019 X/Q	
○ HL 7/024 DL-12.3			● VKHB 2162 33021/Q	VKS 6183
			● VKHB 2082 33019/Q	VKS 6181
○ HL 7/07 DL-10			● VKHB 2162 33021/Q	VKS 6183 25)
			● VKHB 2161 32019 X/Q	VKS 6181
○ HL 7/07 DL-10			● VKHB 2146 33021/QVB091	VKS 6334 26)
			● VKHB 2161 32019 X/Q	
○ HL 7/07 DL-11.5			● VKHB 2162 33021/Q	VKS 6183 25)
			● VKHB 2161 32019 X/Q	VKS 6181
○ HL 7/07 DL-11.5			● VKHB 2146 33021/QVB091	VKS 6334 26)
			● VKHB 2161 32019 X/Q	
○ HL 7/07 DS-10			● VKHB 2162 33021/Q	VKS 6183 25)
			● VKHB 2161 32019 X/Q	VKS 6181





MERCEDES-BENZ

.../...

○ HL 7/07 DS-10	● VKHB 2146	33021/QVB091	VKS 6334	26)
	● VKHB 2161	32019 X/Q		
○ HL 7/07 D-10	● VKHB 2162	33021/Q	VKS 6183	25)
	● VKHB 2161	32019 X/Q	VKS 6181	
○ HL 7/07 D-10	● VKHB 2146	33021/QVB091	VKS 6334	26)
	● VKHB 2161	32019 X/Q		
○ HL 7/07 D-11.5	● VKHB 2162	33021/Q	VKS 6183	25)
	● VKHB 2161	32019 X/Q	VKS 6181	
○ HL 7/07 D-11.5	● VKHB 2146	33021/QVB091	VKS 6334	26)
	● VKHB 2161	32019 X/Q		
○ HL 7/1 DL-10	● VKHB 2162	33021/Q	VKS 6183	25)
	● VKHB 2161	32019 X/Q	VKS 6181	
○ HL 7/1 DL-10	● VKHB 2146	33021/QVB091	VKS 6334	26)
	● VKHB 2161	32019 X/Q		
○ HL 7/1 D-10	● VKHB 2162	33021/Q	VKS 6183	25)
	● VKHB 2161	32019 X/Q	VKS 6181	
○ HL 7/1 D-10	● VKHB 2146	33021/QVB091	VKS 6334	26)
	● VKHB 2161	32019 X/Q		
○ HL 7/1 L-10	● VKHB 2162	33021/Q	VKS 6183	25)
	● VKHB 2161	32019 X/Q	VKS 6181	
○ HL 7/1 L-10	● VKHB 2146	33021/QVB091	VKS 6334	26)
	● VKHB 2161	32019 X/Q		
○ HL 7/1 S-10	● VKHB 2162	33021/Q	VKS 6183	25)
	● VKHB 2161	32019 X/Q	VKS 6181	
○ HL 7/1 S-10	● VKHB 2146	33021/QVB091	VKS 6334	26)
	● VKHB 2161	32019 X/Q		
○ HL 7/15 D-13	● VKHB 2163	33022	VKS 6183	25)
	● VKHB 2164	30220 J2	VKS 6181	
○ HL 7/15 D-13	● VKHB 2163	33022	VKS 6334	26)
	● VKHB 2164	30220 J2		
○ HL 7/18 D-13	● VKHB 2163	33022	VKS 6183	25)
	● VKHB 2164	30220 J2	VKS 6181	
○ HL 7/18 D-13	● VKHB 2163	33022	VKS 6334	26)
	● VKHB 2164	30220 J2		
○ HL 7/1-10	● VKHB 2162	33021/Q	VKS 6183	25)
	● VKHB 2161	32019 X/Q	VKS 6181	
○ HL 7/1-10	● VKHB 2146	33021/QVB091	VKS 6334	26)
	● VKHB 2161	32019 X/Q		
○ HL 7/21 D-10	● VKHB 2162	33021/Q	VKS 6183	25)
	● VKHB 2161	32019 X/Q	VKS 6181	
○ HL 7/21 D-10	● VKHB 2146	33021/QVB091	VKS 6334	26)
	● VKHB 2161	32019 X/Q		
○ HL 7/3 DL-10	● VKHB 2162	33021/Q	VKS 6183	25)
	● VKHB 2161	32019 X/Q	VKS 6181	
○ HL 7/3 DL-10	● VKHB 2146	33021/QVB091	VKS 6334	26)
	● VKHB 2161	32019 X/Q		
○ HL 7/3 D-10	● VKHB 2162	33021/Q	VKS 6183	25)
	● VKHB 2161	32019 X/Q	VKS 6181	
○ HL 7/3 D-10	● VKHB 2146	33021/QVB091	VKS 6334	26)
	● VKHB 2161	32019 X/Q		



SK, 1700 Ser.

●	AL 7/1 D-7			●	VKHB 2172 331974 A/Q VKHB 2161 32019 X/Q	VKS 6194	
●	VD 4/20 DL-7.5, VD 4/26 DL-7.5	VKBA 5039		●	VKHB 2072 32314 J2/Q VKHB 2070 32310 J2/Q	VKS 6150	
●	VL 3/15 D-6.5			●	VKHB 2066 33214/Q VKHB 2068 33210/Q	VKS 6175	
●	VL 4/10 DL-7, VL 4/10 D-7			●	VKHB 2071 332330 B/Q VKHB 2068 33210/Q	VKS 6158 VKS 6146	
●	VL 4/10 D-7	VKBA 5038	VKA 4094	●	VKHB 2071 332330 B/Q VKHB 2070 32310 J2/Q	VKS 6158 VKS 6146	
●	VL 4/16 D-7.5	VKBA 5039		●	VKHB 2072 32314 J2/Q VKHB 2070 32310 J2/Q	VKS 6150	
●	VL 4/23 D-6.7, VL 4/24 D-6.7, VL 4/24 D-7.1, VL 4/25 DL-6.7	VKBA 5038	VKA 4094	●	VKHB 2071 332330 B/Q VKHB 2070 32310 J2/Q	VKS 6158 VKS 6146	
●	VL 4/27 D-7.5, VL 4/28 D-7.5, VL 4/29 D-7.5, VL 4/30 DL-7.5	VKBA 5039		●	VKHB 2072 32314 J2/Q VKHB 2070 32310 J2/Q	VKS 6150	
●	VL 4/31 DL-7.5	VKBA 5038	VKA 4094	●	VKHB 2071 332330 B/Q VKHB 2070 32310 J2/Q	VKS 6158 VKS 6146	
●	VL 4/31 DL-7.5	VKBA 5039		●	VKHB 2072 32314 J2/Q VKHB 2070 32310 J2/Q	VKS 6150	
●	VL 4/8 D-7			●	VKHB 2071 332330 B/Q VKHB 2068 33210/Q	VKS 6158 VKS 6146	
●	VL 5/2 D-9			●	VKHB 2203 JH415647-99401 VKHB 2002 32311 J2		
○	HD 7/016 DG-13			●	VKHB 2163 33022 VKHB 2164 30220 J2	VKS 6183 VKS 6181	25)
○	HD 7/016 DG-13			●	VKHB 2163 33022 VKHB 2164 30220 J2	VKS 6334	26)
○	HL 4/038 D-12, HL 4/039 D-12, HL 4/06 DL-12, HL 4/06 D-12	VKBA 5056	VKA 4110	●	VKHB 2124 33020/Q VKHB 2158 33117/Q	VKS 6176	
○	HL 7/013 D-16			●	VKHB 2163 33022 VKHB 2165 33220	VKS 6183 VKS 6181	
○	HL 7/015 DL-13			●	VKHB 2163 33022 VKHB 2164 30220 J2	VKS 6183 VKS 6181	25)
○	HL 7/015 DL-13			●	VKHB 2163 33022 VKHB 2164 30220 J2	VKS 6334	26)
○	HL 7/015 D-13			●	VKHB 2163 33022 VKHB 2164 30220 J2	VKS 6183 VKS 6181	25)
○	HL 7/015 D-13			●	VKHB 2163 33022 VKHB 2164 30220 J2	VKS 6334	26)





MERCEDES-BENZ .../...

○ HL 7/ 024 DL-12.3, HL 7/024 D-12.3, HL 7/025 D-12.3			● VKHB 2162 33021/Q VKHB 2082 33019/Q	VKS 6183 VKS 6181
○ HL 7/07 DL-10			● VKHB 2162 33021/Q VKHB 2161 32019 X/Q	VKS 6183 25) VKS 6181
○ HL 7/07 DL-10			● VKHB 2146 33021/QVB091 VKHB 2161 32019 X/Q	VKS 6334 26)
○ HL 7/07 DL-11.5			● VKHB 2162 33021/Q VKHB 2161 32019 X/Q	VKS 6183 25) VKS 6181
○ HL 7/07 DL-11.5			● VKHB 2146 33021/QVB091 VKHB 2161 32019 X/Q	VKS 6334 26)
○ HL 7/07 D-10			● VKHB 2162 33021/Q VKHB 2161 32019 X/Q	VKS 6183 25) VKS 6181
○ HL 7/07 D-10			● VKHB 2146 33021/QVB091 VKHB 2161 32019 X/Q	VKS 6334 26)
○ HL 7/07 D-11.5			● VKHB 2162 33021/Q VKHB 2161 32019 X/Q	VKS 6183 25) VKS 6181
○ HL 7/07 D-11.5			● VKHB 2146 33021/QVB091 VKHB 2161 32019 X/Q	VKS 6334 26)
○ HL 7/07 D-11.5			● VKHB 2162 33021/Q VKHB 2161 32019 X/Q	VKS 6183 25) VKS 6181
○ HL 7/07 D-11.5			● VKHB 2146 33021/QVB091 VKHB 2161 32019 X/Q	VKS 6334 26)
○ HL 7/18 D-13			● VKHB 2163 33022 VKHB 2164 30220 J2	VKS 6183 25) VKS 6181
○ HL 7/18 D-13			● VKHB 2163 33022 VKHB 2164 30220 J2	VKS 6334 26)
○ HL 7/26 DL-12.3, HL 7/26 D-12.3			● VKHB 2162 33021/Q VKHB 2082 33019/Q	VKS 6183 VKS 6181
○ HL 7/3 D-10			● VKHB 2162 33021/Q VKHB 2161 32019 X/Q	VKS 6183 25) VKS 6181
○ HL 7/3 D-10			● VKHB 2146 33021/QVB091 VKHB 2161 32019 X/Q	VKS 6334 26)

SK, 1800 Ser.

● AL 7/1 D-7, AL 7/ 1 D-7.637, AL 7/ 1 D-7/5.217			● VKHB 2172 331974 A/Q VKHB 2161 32019 X/Q	VKS 6194
● VD 4/26 DL-7.5	VKBA 5039		● VKHB 2072 32314 J2/Q VKHB 2070 32310 J2/Q	VKS 6150
● VL 3/15 D-6.5			● VKHB 2066 33214/Q VKHB 2068 33210/Q	VKS 6175
● VL 4/10 D-7	VKBA 5038	VKA 4094	● VKHB 2071 332330 B/Q VKHB 2070 32310 J2/Q	VKS 6158 VKS 6146
● VL 4/16 D-7.5	VKBA 5039		● VKHB 2072 32314 J2/Q VKHB 2070 32310 J2/Q	VKS 6150



•	VL 4/23 D-6.7, VL 4/24 D-6.7, VL 4/24 D-7.1, VL 4/25 DL-6.7, VL 4/25 DL-7.1	VKBA 5038	VKA 4094	•	•	VKHB 2071 VKHB 2070	332330 B/Q 32310 J2/Q	VKS 6158 VKS 6146	
•	VL 4/27 D-7.5	VKBA 5039		•	•	VKHB 2072 VKHB 2070	32314 J2/Q 32310 J2/Q	VKS 6150	
•	VL 4/27 D-7.5	VKBA 5039		•	•	VKHB 2072 VKHB 2070	32314 J2/Q 32310 J2/Q	VKS 6150	24)
•	VL 4/28 D-7.5, VL 4/29 D-7.5, VL 4/30 DL-7.5	VKBA 5039		•	•	VKHB 2072 VKHB 2070	32314 J2/Q 32310 J2/Q	VKS 6150	
•	VL 4/31 DL-7.5	VKBA 5038	VKA 4094	•	•	VKHB 2071 VKHB 2070	332330 B/Q 32310 J2/Q	VKS 6158 VKS 6146	
•	VL 4/31 DL-7.5	VKBA 5039		•	•	VKHB 2072 VKHB 2070	32314 J2/Q 32310 J2/Q	VKS 6150	
•	VL 4/36 D-6.7, VL 4/38 D-7.1	VKBA 5038	VKA 4094	•	•	VKHB 2071 VKHB 2070	332330 B/Q 32310 J2/Q	VKS 6158 VKS 6146	
•	VL 5/1 D-9		VKA 4095	•	•	VKHB 2002 VKHB 2002	32311 J2 32311 J2	VKS 6150	
•	VL 5/2 D-9			•	•	VKHB 2203 VKHB 2002	JH415647- 99401 32311 J2		
•			VKA 4095	•	•	VKHB 2002 VKHB 2002	32311 J2 32311 J2	VKS 6150	
○	HL 4/038 D-12, HL 4/039 D-12, HL 4/06 DL-12, HL 4/06 D-12	VKBA 5056	VKA 4110	•	•	VKHB 2124 VKHB 2158	33020/Q 33117/Q	VKS 6176	
○	HL 7/013 D-16			•	•	VKHB 2163 VKHB 2165	33022 33220	VKS 6183 VKS 6181	
○	HL 7/015 DL-13			•	•	VKHB 2163 VKHB 2164	33022 30220 J2	VKS 6183 VKS 6181	25)
○	HL 7/015 DL-13			•	•	VKHB 2163 VKHB 2164	33022 30220 J2	VKS 6334	26)
○	HL 7/015 D-13			•	•	VKHB 2163 VKHB 2164	33022 30220 J2	VKS 6183 VKS 6181	25)
○	HL 7/015 D-13			•	•	VKHB 2163 VKHB 2164	33022 30220 J2	VKS 6334	26)
○	HL 7/ 024 DL- 12.3, HL 7/024 D-12.3, HL 7/025 D-12.3			•	•	VKHB 2162 VKHB 2082	33021/Q 33019/Q	VKS 6183 VKS 6181	
○	HL 7/07 DL-10			•	•	VKHB 2162 VKHB 2161	33021/Q 32019 X/Q	VKS 6183 VKS 6181	25)
○	HL 7/07 DL-10			•	•	VKHB 2146 VKHB 2161	33021/QVB091 32019 X/Q	VKS 6334	26)
○	HL 7/07 DL-11.5			•	•	VKHB 2162 VKHB 2161	33021/Q 32019 X/Q	VKS 6183 VKS 6181	25)
○	HL 7/07 DL-11.5			•	•	VKHB 2163 VKHB 2164	33022 30220 J2	VKS 6183 VKS 6181	25)
○	HL 7/07 DL-11.5			•	•	VKHB 2146 VKHB 2161	33021/QVB091 32019 X/Q	VKS 6334	26)





MERCEDES-BENZ .../...

○ HL 7/07 DL-11.5			● VKHB 2163 33022	VKS 6334	26)
			● VKHB 2164 30220 J2		
○ HL 7/07 D-10			● VKHB 2162 33021/Q	VKS 6183	25)
			● VKHB 2161 32019 X/Q	VKS 6181	
○ HL 7/07 D-10			● VKHB 2146 33021/QVB091	VKS 6334	26)
			● VKHB 2161 32019 X/Q		
○ HL 7/07 D-11.5			● VKHB 2162 33021/Q	VKS 6183	25)
			● VKHB 2161 32019 X/Q	VKS 6181	
○ HL 7/07 D-11.5			● VKHB 2146 33021/QVB091	VKS 6334	26)
			● VKHB 2161 32019 X/Q		
○ HL 7/07 D-11.5/ 4.572			● VKHB 2162 33021/Q	VKS 6183	25)
			● VKHB 2161 32019 X/Q	VKS 6181	
○ HL 7/07 D-11.5/ 4.572			● VKHB 2146 33021/QVB091	VKS 6334	26)
			● VKHB 2161 32019 X/Q		
○ HL 7/07 D-11.5			● VKHB 2162 33021/Q	VKS 6183	25)
			● VKHB 2161 32019 X/Q	VKS 6181	
○ HL 7/07 D-11.5			● VKHB 2146 33021/QVB091	VKS 6334	26)
			● VKHB 2161 32019 X/Q		
○ HL 7/26 DL-12.3, HL 7/26 D-12.3			● VKHB 2162 33021/Q	VKS 6183	
			● VKHB 2082 33019/Q	VKS 6181	
○ NR 4/11 DL-7.5	VKBA 5038	VKA 4094	● VKHB 2071 332330 B/Q	VKS 6158	
			● VKHB 2070 32310 J2/Q	VKS 6146	
○ NR 4/22-8, NS 4/11 D-10	VKBA 5052		● VKHB 2082 33019/Q	VKS 6154	
			● VKHB 2028 33215/Q		

SK, 1900 Ser.

● AL 7/1 D-7			● VKHB 2172 331974 A/Q		
			● VKHB 2161 32019 X/Q	VKS 6194	
● VD 4/14 DL-7	VKBA 5038	VKA 4094	● VKHB 2071 332330 B/Q	VKS 6158	
			● VKHB 2070 32310 J2/Q	VKS 6146	
● VD 4/20 DL-7.5			● VKHB 2071 332330 B/Q	VKS 6158	
			● VKHB 2068 33210/Q	VKS 6146	
● VD 4/20 DL-7.5, VD 4/26 DL-7.5	VKBA 5039		● VKHB 2072 32314 J2/Q	VKS 6150	
			● VKHB 2070 32310 J2/Q		
● VL 3/8 D-6.5			● VKHB 2066 33214/Q	VKS 6175	
			● VKHB 2068 33210/Q		
● VL 3/8-6			● VKHB 2066 33214/Q	VKS 6175	10)
			● VKHB 2067 33209/Q		
● VL 3/8-6			● VKHB 2066 33214/Q	VKS 6175	11)
			● VKHB 2068 33210/Q		
● VL 4/10 D-7			● VKHB 2071 332330 B/Q	VKS 6158	
			● VKHB 2068 33210/Q	VKS 6146	
● VL 4/10 D-7			● VKHB 2071 332330 B/Q	VKS 6158	13)
			● VKHB 2068 33210/Q	VKS 6146	
● VL 4/10 D-7	VKBA 5038	VKA 4094	● VKHB 2071 332330 B/Q	VKS 6158	
			● VKHB 2070 32310 J2/Q	VKS 6146	
● VL 4/10 D-7	VKBA 5038	VKA 4094	● VKHB 2071 332330 B/Q	VKS 6158	14)
			● VKHB 2070 32310 J2/Q	VKS 6146	



•	VL 4/15 D-7.5, VL 4/16 D-7.5, VL 4/19 D-7.5	VKBA 5039		•	VKHB 2072 VKHB 2070	32314 J2/Q 32310 J2/Q	VKS 6150	
•	VL 4/2 D-7			•	VKHB 2070	32310 J2/Q		
•	VL 4/23 D-6.7, VL 4/24 D-6.7, VL 4/25 DL-6.7	VKBA 5038	VKA 4094	•	VKHB 2071 VKHB 2070	332330 B/Q 32310 J2/Q	VKS 6158 VKS 6146	
•	VL 4/27 D-7.5, VL 4/28 D-7.5, VL 4/29 D-7.5, VL 4/31 DL-7.5	VKBA 5039		•	VKHB 2072 VKHB 2070	32314 J2/Q 32310 J2/Q	VKS 6150	
•	VL 4/7 D-7			•	VKHB 2071 VKHB 2068	332330 B/Q 33210/Q	VKS 6158 VKS 6146	13)
•	VL 4/7 D-7	VKBA 5038	VKA 4094	•	VKHB 2071 VKHB 2070	332330 B/Q 32310 J2/Q	VKS 6158 VKS 6146	
•	VL 4/7 D-7	VKBA 5038	VKA 4094	•	VKHB 2071 VKHB 2070	332330 B/Q 32310 J2/Q	VKS 6158 VKS 6146	14)
•	VL 4/8 D-7			•	VKHB 2071 VKHB 2068	332330 B/Q 33210/Q	VKS 6158 VKS 6146	
•	VL 4/9 D-7			•	VKHB 2071 VKHB 2068	332330 B/Q 33210/Q	VKS 6158 VKS 6146	13)
•	VL 4/9 D-7	VKBA 5038	VKA 4094	•	VKHB 2071 VKHB 2070	332330 B/Q 32310 J2/Q	VKS 6158 VKS 6146	
•	VL 4/9 D-7	VKBA 5038	VKA 4094	•	VKHB 2071 VKHB 2070	332330 B/Q 32310 J2/Q	VKS 6158 VKS 6146	14)
•	VL 5/1 D-9, VL 5/2 D-9			•	VKHB 2203 VKHB 2002	JH415647- 99401 32311 J2		
○	HD 7/016 DG-13			•	VKHB 2163 VKHB 2164	33022 30220 J2	VKS 6183 VKS 6181	25)
○	HD 7/016 DG-13			•	VKHB 2163 VKHB 2164	33022 30220 J2	VKS 6334	26)
○	HL 7/013 D-16			•	VKHB 2163 VKHB 2165	33022 33220	VKS 6183 VKS 6181	
○	HL 7/015 DL-13			•	VKHB 2163 VKHB 2164	33022 30220 J2	VKS 6183 VKS 6181	25)
○	HL 7/015 DL-13			•	VKHB 2163 VKHB 2164	33022 30220 J2	VKS 6334	26)
○	HL 7/015 DS-13			•	VKHB 2163 VKHB 2164	33022 30220 J2	VKS 6183 VKS 6181	25)
○	HL 7/015 DS-13			•	VKHB 2163 VKHB 2164	33022 30220 J2	VKS 6334	26)
○	HL 7/015 D-13			•	VKHB 2163 VKHB 2164	33022 30220 J2	VKS 6183 VKS 6181	25)
○	HL 7/015 D-13			•	VKHB 2163 VKHB 2164	33022 30220 J2	VKS 6334	26)
○	HL 7/07 DL-10			•	VKHB 2162 VKHB 2161	33021/Q 32019 X/Q	VKS 6183 VKS 6181	25)
○	HL 7/07 DL-10			•	VKHB 2146 VKHB 2161	33021/QVB091 32019 X/Q	VKS 6334	26)
○	HL 7/07 D-10			•	VKHB 2162 VKHB 2161	33021/Q 32019 X/Q	VKS 6183 VKS 6181	25)





MERCEDES-BENZ .../...

○ HL 7/07 D-10			● VKHB 2146 33021/QVB091 VKHB 2161 32019 X/Q	VKS 6334 26)
○ HL 7/15 D-13			● VKHB 2163 33022 VKHB 2164 30220 J2	VKS 6183 25) VKS 6181
○ HL 7/15 D-13			● VKHB 2163 33022 VKHB 2164 30220 J2	VKS 6334 26)
○ HL 7/18 D-13			● VKHB 2163 33022 VKHB 2164 30220 J2	VKS 6183 25) VKS 6181
○ HL 7/18 D-13			● VKHB 2163 33022 VKHB 2164 30220 J2	VKS 6334 26)
○ HL 7/1-10			● VKHB 2162 33021/Q VKHB 2161 32019 X/Q	VKS 6183 25) VKS 6181
○ HL 7/1-10			● VKHB 2146 33021/QVB091 VKHB 2161 32019 X/Q	VKS 6334 26)
○ NS 4/11 D-10	VKBA 5052		● VKHB 2082 33019/Q VKHB 2028 33215/Q	VKS 6154

SK, 2000 Ser.

● AL 7/1 D-7, AL 7/1 D-7.637, AL 7/1 D-7.769, AL 7/1 D-7/5.217			● VKHB 2172 331974 A/Q VKHB 2161 32019 X/Q	VKS 6194
● VD 4/14 DL-7	VKBA 5038	VKA 4094	● VKHB 2071 332330 B/Q VKHB 2070 32310 J2/Q	VKS 6158 VKS 6146
● VD 4/20 DL-7.5	VKBA 5039		● VKHB 2072 32314 J2/Q VKHB 2070 32310 J2/Q	VKS 6150
● VL 3/13 D-5.3			● VKHB 2066 33214/Q VKHB 2067 33209/Q	VKS 6175
● VL 4/10 D-7			● VKHB 2071 332330 B/Q VKHB 2068 33210/Q	VKS 6158 VKS 6146
● VL 4/10 D-7, VL 4/14 D-7	VKBA 5038	VKA 4094	● VKHB 2071 332330 B/Q VKHB 2070 32310 J2/Q	VKS 6158 VKS 6146
● VL 4/16 D-7.5	VKBA 5039		● VKHB 2072 32314 J2/Q VKHB 2070 32310 J2/Q	VKS 6150
● VL 4/23 D-6.7, VL 4/24 D-6.7, VL 4/24 D-7.1	VKBA 5038	VKA 4094	● VKHB 2071 332330 B/Q VKHB 2070 32310 J2/Q	VKS 6158 VKS 6146
● VL 4/27 D-7.5, VL 4/28 D-7.5	VKBA 5039		● VKHB 2072 32314 J2/Q VKHB 2070 32310 J2/Q	VKS 6150
● VL 4/9 D-7	VKBA 5038	VKA 4094	● VKHB 2071 332330 B/Q VKHB 2070 32310 J2/Q	VKS 6158 VKS 6146
● VL 5/1 D-9			● VKHB 2203 JH415647-99401 VKHB 2002 32311 J2	
● VL 5/1 D-9		VKA 4095	● VKHB 2002 32311 J2 VKHB 2002 32311 J2	VKS 6150
● VL 5/2 D-9			● VKHB 2203 JH415647-99401 VKHB 2002 32311 J2	
○ HD 7/014 DGS-16			● VKHB 2163 33022 VKHB 2165 33220	VKS 6183 VKS 6181



○ HD 7/19 DG-13			● VKHB 2163 33022	VKS 6183 25)
			● VKHB 2164 30220 J2	VKS 6181
○ HD 7/19 DG-13			● VKHB 2163 33022	VKS 6334 26)
			● VKHB 2164 30220 J2	
○ HD 7/2 DG-10			● VKHB 2162 33021/Q	VKS 6183 25)
			● VKHB 2161 32019 X/Q	VKS 6181
○ HD 7/2 DG-10			● VKHB 2146 33021/QVB091	VKS 6334 26)
			● VKHB 2161 32019 X/Q	
○ HL 4/01 D-10	VKBA 5056	VKA 4110	● VKHB 2124 33020/Q	VKS 6176
			● VKHB 2158 33117/Q	
○ HL 4/32 D-10.6			● VKHB 2082 33019/Q	
			● VKHB 2028 33215/Q	
○ HL 7/013 D-16			● VKHB 2163 33022	VKS 6183
			● VKHB 2165 33220	VKS 6181
○ HL 7/015 DL-13			● VKHB 2163 33022	VKS 6183 25)
			● VKHB 2164 30220 J2	VKS 6181
○ HL 7/015 DL-13			● VKHB 2163 33022	VKS 6334 26)
			● VKHB 2164 30220 J2	
○ HL 7/015 DS-13			● VKHB 2163 33022	VKS 6183 25)
			● VKHB 2164 30220 J2	VKS 6181
○ HL 7/015 DS-13			● VKHB 2163 33022	VKS 6334 26)
			● VKHB 2164 30220 J2	
○ HL 7/015 D-13			● VKHB 2163 33022	VKS 6183 25)
			● VKHB 2164 30220 J2	VKS 6181
○ HL 7/015 D-13			● VKHB 2163 33022	VKS 6334 26)
			● VKHB 2164 30220 J2	
○ HL 7/015 D-13/ 4.572			● VKHB 2163 33022	VKS 6183 25)
			● VKHB 2164 30220 J2	VKS 6181
○ HL 7/015 D-13/ 4.572			● VKHB 2163 33022	VKS 6334 26)
			● VKHB 2164 30220 J2	
○ HL 7/021 D-10			● VKHB 2162 33021/Q	VKS 6183 25)
			● VKHB 2161 32019 X/Q	VKS 6181
○ HL 7/021 D-10			● VKHB 2146 33021/QVB091	VKS 6334 26)
			● VKHB 2161 32019 X/Q	
○ HL 7/07 DL-10			● VKHB 2162 33021/Q	VKS 6183 25)
			● VKHB 2161 32019 X/Q	VKS 6181
○ HL 7/07 DL-10			● VKHB 2146 33021/QVB091	VKS 6334 26)
			● VKHB 2161 32019 X/Q	
○ HL 7/07 DS-10			● VKHB 2162 33021/Q	VKS 6183 25)
			● VKHB 2161 32019 X/Q	VKS 6181
○ HL 7/07 DS-10			● VKHB 2146 33021/QVB091	VKS 6334 26)
			● VKHB 2161 32019 X/Q	
○ HL 7/07 D-10			● VKHB 2162 33021/Q	VKS 6183 25)
			● VKHB 2161 32019 X/Q	VKS 6181
○ HL 7/07 D-10			● VKHB 2146 33021/QVB091	VKS 6334 26)
			● VKHB 2161 32019 X/Q	
○ HL 7/1 DL-10			● VKHB 2162 33021/Q	VKS 6183 25)
			● VKHB 2161 32019 X/Q	VKS 6181
○ HL 7/1 DL-10			● VKHB 2146 33021/QVB091	VKS 6334 26)
			● VKHB 2161 32019 X/Q	
○ HL 7/18 D-13			● VKHB 2163 33022	VKS 6183 25)
			● VKHB 2164 30220 J2	VKS 6181





MERCEDES-BENZ

.../...

	○	HL 7/18 D-13			●	VKHB 2163 VKHB 2164	33022 30220 J2	VKS 6334	26)
SK, 2200 Ser.	●	VD 4/14 DL-7	VKBA 5038	VKA 4094	●	VKHB 2071 VKHB 2070	332330 B/Q 32310 J2/Q	VKS 6158 VKS 6146	
	●	VD 4/20 DL-7.5			●	VKHB 2071 VKHB 2068	332330 B/Q 33210/Q	VKS 6158 VKS 6146	
	●	VD 4/20 DL-7.5	VKBA 5039		●	VKHB 2072 VKHB 2070	32314 J2/Q 32310 J2/Q	VKS 6150	
	●	VL 3/8 D-6.5			●	VKHB 2066 VKHB 2068	33214/Q 33210/Q	VKS 6175	
	●	VL 3/8-6			●	VKHB 2066 VKHB 2067	33214/Q 33209/Q	VKS 6175	10)
	●	VL 3/8-6			●	VKHB 2066 VKHB 2068	33214/Q 33210/Q	VKS 6175	11)
	●	VL 4/10 DL-7, VL 4/10 D-7			●	VKHB 2071 VKHB 2068	332330 B/Q 33210/Q	VKS 6158 VKS 6146	
	●	VL 4/10 D-7			●	VKHB 2071 VKHB 2068	332330 B/Q 33210/Q	VKS 6158 VKS 6146	13)
	●	VL 4/10 D-7	VKBA 5038	VKA 4094	●	VKHB 2071 VKHB 2070	332330 B/Q 32310 J2/Q	VKS 6158 VKS 6146	
	●	VL 4/10 D-7	VKBA 5038	VKA 4094	●	VKHB 2071 VKHB 2070	332330 B/Q 32310 J2/Q	VKS 6158 VKS 6146	14)
	●	VL 4/15 D-7.5, VL 4/16 D-7.5, VL 4/28 D-7.5, VL 4/30 DL-7.5, VL 4/30 D-7.5	VKBA 5039		●	VKHB 2072 VKHB 2070	32314 J2/Q 32310 J2/Q	VKS 6150	
	●	VL 4/8 D-7, VL 4/9 D-7			●	VKHB 2071 VKHB 2068	332330 B/Q 33210/Q	VKS 6158 VKS 6146	
	●	VL 4/9 D-7			●	VKHB 2071 VKHB 2068	332330 B/Q 33210/Q	VKS 6158 VKS 6146	13)
	●	VL 4/9 D-7	VKBA 5038	VKA 4094	●	VKHB 2071 VKHB 2070	332330 B/Q 32310 J2/Q	VKS 6158 VKS 6146	
	●	VL 4/9 D-7	VKBA 5038	VKA 4094	●	VKHB 2071 VKHB 2070	332330 B/Q 32310 J2/Q	VKS 6158 VKS 6146	14)
	○	HD 4/02 DG-10, HD 4/02 GD-10, HD 4/03 D-10, HD 4/2 DG-10	VKBA 5056	VKA 4110	●	VKHB 2124 VKHB 2158	33020/Q 33117/Q	VKS 6176	
	○	HD 4/21 DG-10, HD 4/21 G-10, HD 4/22 DG-10, HD 4/22 D-10, HD 4/22-10	VKBA 5052		●	VKHB 2082 VKHB 2028	33019/Q 33215/Q	VKS 6154	
	○	HD 7/09 DG-10			●	VKHB 2162 VKHB 2161	33021/Q 32019 X/Q	VKS 6183 VKS 6181	25)
	○	HD 7/09 DG-10			●	VKHB 2146 VKHB 2161	33021/QVB091 32019 X/Q	VKS 6334	26)



○ HD 7/11 DG-9			● VKHB 2160 32021 X/Q	VKS 6183	
			● VKHB 2161 32019 X/Q	VKS 6181	
○ HD 7/19 DG-13			● VKHB 2163 33022	VKS 6183	25)
			● VKHB 2164 30220 J2	VKS 6181	
○ HD 7/19 DG-13			● VKHB 2163 33022	VKS 6334	26)
			● VKHB 2164 30220 J2		
○ HD 7/2 DG-10			● VKHB 2162 33021/Q	VKS 6183	25)
			● VKHB 2161 32019 X/Q	VKS 6181	
○ HD 7/2 DG-10			● VKHB 2146 33021/QVB091	VKS 6334	26)
			● VKHB 2161 32019 X/Q		
○ HD 7/2 DLG-10			● VKHB 2162 33021/Q	VKS 6183	25)
			● VKHB 2161 32019 X/Q	VKS 6181	
○ HD 7/2 DLG-10			● VKHB 2146 33021/QVB091	VKS 6334	26)
			● VKHB 2161 32019 X/Q		
○ HD 7/5 DG-10			● VKHB 2162 33021/Q	VKS 6183	25)
			● VKHB 2161 32019 X/Q	VKS 6181	
○ HD 7/5 DG-10			● VKHB 2146 33021/QVB091	VKS 6334	26)
			● VKHB 2161 32019 X/Q		
○ HL 4/01 DL-10, HL 4/01 D-10, HL 4/01-10, HL 4/06 DL-12, HL 4/06 D-12	VKBA 5056	VKA 4110	● VKHB 2124 33020/Q	VKS 6176	
			● VKHB 2158 33117/Q		
○ HL 5/2 ZL-10	VKBA 5052		● VKHB 2082 33019/Q	VKS 6154	
			● VKHB 2028 33215/Q		
○ HL 7/015 DS-13			● VKHB 2163 33022	VKS 6183	25)
			● VKHB 2164 30220 J2	VKS 6181	
○ HL 7/015 DS-13			● VKHB 2163 33022	VKS 6334	26)
			● VKHB 2164 30220 J2		
○ HL 7/015 D-13			● VKHB 2163 33022	VKS 6183	25)
			● VKHB 2164 30220 J2	VKS 6181	
○ HL 7/015 D-13			● VKHB 2163 33022	VKS 6334	26)
			● VKHB 2164 30220 J2		
○ HL 7/021 DL-10			● VKHB 2162 33021/Q	VKS 6183	25)
			● VKHB 2161 32019 X/Q	VKS 6181	
○ HL 7/021 DL-10			● VKHB 2146 33021/QVB091	VKS 6334	26)
			● VKHB 2161 32019 X/Q		
○ HL 7/021 D-10			● VKHB 2162 33021/Q	VKS 6183	25)
			● VKHB 2161 32019 X/Q	VKS 6181	
○ HL 7/021 D-10			● VKHB 2146 33021/QVB091	VKS 6334	26)
			● VKHB 2161 32019 X/Q		
○ HL 7/024 DL-12.3			● VKHB 2162 33021/Q	VKS 6183	
			● VKHB 2082 33019/Q	VKS 6181	
○ HL 7/07 DL-10			● VKHB 2162 33021/Q	VKS 6183	25)
			● VKHB 2161 32019 X/Q	VKS 6181	
○ HL 7/07 DL-10			● VKHB 2146 33021/QVB091	VKS 6334	26)
			● VKHB 2161 32019 X/Q		
○ HL 7/07 DS-10			● VKHB 2162 33021/Q	VKS 6183	25)
			● VKHB 2161 32019 X/Q	VKS 6181	
○ HL 7/07 DS-10			● VKHB 2146 33021/QVB091	VKS 6334	26)
			● VKHB 2161 32019 X/Q		
○ HL 7/07 D-10			● VKHB 2162 33021/Q	VKS 6183	25)
			● VKHB 2161 32019 X/Q	VKS 6181	
○ HL 7/07 D-10			● VKHB 2146 33021/QVB091	VKS 6334	26)
			● VKHB 2161 32019 X/Q		















MERCEDES-BENZ

.../...

○ HL 7/1 DL-10		●	VKHB 2051	33213/Q	VKS 6157	26)
		●	VKHB 2065	33208/Q		
○ HL 7/1 DL-10		●	VKHB 2162	33021/Q	VKS 6183	25)
		●	VKHB 2161	32019 X/Q	VKS 6181	
○ HL 7/1 DL-10		●	VKHB 2146	33021/QVB091	VKS 6334	26)
		●	VKHB 2161	32019 X/Q		
○ HL 7/1 D-10		●	VKHB 2162	33021/Q	VKS 6183	25)
		●	VKHB 2161	32019 X/Q	VKS 6181	
○ HL 7/1 D-10		●	VKHB 2146	33021/QVB091	VKS 6334	26)
		●	VKHB 2161	32019 X/Q		
○ HL 7/1 L-10		●	VKHB 2162	33021/Q	VKS 6183	25)
		●	VKHB 2161	32019 X/Q	VKS 6181	
○ HL 7/1 L-10		●	VKHB 2146	33021/QVB091	VKS 6334	26)
		●	VKHB 2161	32019 X/Q		
○ HL 7/10 D-9		●	VKHB 2160	32021 X/Q	VKS 6183	
		●	VKHB 2161	32019 X/Q	VKS 6181	
○ HL 7/18 D-13		●	VKHB 2163	33022	VKS 6183	25)
		●	VKHB 2164	30220 J2	VKS 6181	
○ HL 7/18 D-13		●	VKHB 2163	33022	VKS 6334	26)
		●	VKHB 2164	30220 J2		
○ HL 7/1-10		●	VKHB 2162	33021/Q	VKS 6183	25)
		●	VKHB 2161	32019 X/Q	VKS 6181	
○ HL 7/1-10		●	VKHB 2146	33021/QVB091	VKS 6334	26)
		●	VKHB 2161	32019 X/Q		
○ HL 7/3 DL-10		●	VKHB 2162	33021/Q	VKS 6183	25)
		●	VKHB 2161	32019 X/Q	VKS 6181	
○ HL 7/3 DL-10		●	VKHB 2146	33021/QVB091	VKS 6334	26)
		●	VKHB 2161	32019 X/Q		
○ HL 7/3 DS-10		●	VKHB 2162	33021/Q	VKS 6183	25)
		●	VKHB 2161	32019 X/Q	VKS 6181	
○ HL 7/3 DS-10		●	VKHB 2146	33021/QVB091	VKS 6334	26)
		●	VKHB 2161	32019 X/Q		
○ HL 7/3 D-10		●	VKHB 2051	33213/Q	VKS 6157	26)
		●	VKHB 2065	33208/Q		
○ HL 7/3 D-10		●	VKHB 2162	33021/Q	VKS 6183	25)
		●	VKHB 2161	32019 X/Q	VKS 6181	
○ HL 7/3 D-10, HL 7/3 D-10		●	VKHB 2146	33021/QVB091	VKS 6334	26)
		●	VKHB 2161	32019 X/Q		
○ HL 7/4 D-10		●	VKHB 2162	33021/Q	VKS 6183	25)
		●	VKHB 2161	32019 X/Q	VKS 6181	
○ HL 7/4 D-10		●	VKHB 2146	33021/QVB091	VKS 6334	26)
		●	VKHB 2161	32019 X/Q		
○ HL7/2 DG-10		●	VKHB 2162	33021/Q	VKS 6183	25)
		●	VKHB 2161	32019 X/Q	VKS 6181	
○ HL7/2 DG-10		●	VKHB 2146	33021/QVB091	VKS 6334	26)
		●	VKHB 2161	32019 X/Q		
○ NR 4/10 DL-6		●	VKHB 2070	32310 J2/Q		
○ NR 4/10 DL-6, NR 4/11 DL-7.5	VKBA 5038	VKA 4094	●	VKHB 2071	332330 B/Q	VKS 6158
			●	VKHB 2070	32310 J2/Q	VKS 6146

									
		<ul style="list-style-type: none"> ○ NS 4/10 D-6 ○ NS 4/10 D-6.7 ○ NS 4/11 D-10 	VKBA 5052			<ul style="list-style-type: none"> ● VKHB 2070 ● VKHB 2071 ● VKHB 2068 ● VKHB 2082 ● VKHB 2028 	32310 J2/Q 332330 B/Q 33210/Q 33019/Q 33215/Q	VKS 6158 VKS 6146 VKS 6154	
SK, 2300 Ser.		<ul style="list-style-type: none"> ● VD 4/26 DL-7.5 ○ HD 7/5 DG-10 ○ HD 7/5 DG-10 	VKBA 5039			<ul style="list-style-type: none"> ● VKHB 2072 ● VKHB 2070 ● VKHB 2162 ● VKHB 2161 ● VKHB 2146 ● VKHB 2161 	32314 J2/Q 32310 J2/Q 33021/Q 32019 X/Q 33021/QVB091 32019 X/Q	VKS 6150 VKS 6183 VKS 6181 VKS 6334	25) 26)
SK, 2400 Ser.		<ul style="list-style-type: none"> ● VD 4/14 DL-7 ● VD 4/20 DL-7.5, VD 4/26 DL-7.5 ● VL 4/10 DL-7, VL 4/10 D-7 ● VL 4/10 D-7 ● VL 4/15 D-7.5, VL 4/16 D-7.5 ● VL 4/23 D-6.7, VL 4/24 D-6.7, VL 4/24 D-7.1, VL 4/25 DL-6.7 ● VL 4/27 D-7.5 ● VL 4/28 D-7.5 ● VL 4/28 D-7.5, VL 4/29 D-7.5, VL 4/30 DL-7.5, VL 4/30 D-7.5, VL 4/31 DL-7.5 ● VL 4/9 D-7 ● VL 5/2 D-9 ○ HD 4/21 DG-10, HD 4/22 D-10 ○ HD 7/016 DG-13 ○ HD 7/016 DG-13 ○ HD 7/09 DG-10 	VKBA 5038 VKBA 5039 VKBA 5038 VKBA 5039 VKBA 5038 VKBA 5039 VKBA 5038 VKBA 5039 VKBA 5038 VKBA 5038 VKBA 5038 VKBA 5039 VKBA 5038 VKBA 5052	VKA 4094 VKA 4094 VKA 4094 VKA 4094 VKA 4094 VKA 4094 VKA 4094 VKA 4094 VKA 4094 VKA 4094	<ul style="list-style-type: none"> ● VKHB 2071 ● VKHB 2070 ● VKHB 2072 ● VKHB 2070 ● VKHB 2071 ● VKHB 2068 ● VKHB 2071 ● VKHB 2070 ● VKHB 2072 ● VKHB 2070 ● VKHB 2071 ● VKHB 2070 ● VKHB 2072 ● VKHB 2070 ● VKHB 2071 ● VKHB 2070 ● VKHB 2203 ● VKHB 2002 ● VKHB 2082 ● VKHB 2028 ● VKHB 2163 ● VKHB 2164 ● VKHB 2163 ● VKHB 2164 ● VKHB 2162 ● VKHB 2161 	332330 B/Q 32310 J2/Q 32314 J2/Q 32310 J2/Q 332330 B/Q 33210/Q 332330 B/Q 32310 J2/Q 32314 J2/Q 32310 J2/Q 332330 B/Q 32310 J2/Q 332330 B/Q 32310 J2/Q 332330 B/Q 32310 J2/Q 332330 B/Q 32310 J2/Q 332330 B/Q 32310 J2/Q 33022 30220 J2 33022 30220 J2 33021/Q 32019 X/Q	VKS 6158 VKS 6146 VKS 6150 VKS 6158 VKS 6146 VKS 6158 VKS 6146 VKS 6158 VKS 6146 VKS 6158 VKS 6146 VKS 6158 VKS 6146 VKS 6158 VKS 6146 VKS 6158 VKS 6146 VKS 6158 VKS 6146 VKS 6158 VKS 6146 VKS 6183 VKS 6181 VKS 6334 VKS 6334 VKS 6183 VKS 6181	25) 26) 25)	





MERCEDES-BENZ

.../...

○ HD 7/09 DG-10			● VKHB 2146	33021/QVB091	VKS 6334	26)
			● VKHB 2161	32019 X/Q		
○ HD 7/19 DG-13			● VKHB 2163	33022	VKS 6183	25)
			● VKHB 2164	30220 J2	VKS 6181	
○ HD 7/19 DG-13			● VKHB 2163	33022	VKS 6334	26)
			● VKHB 2164	30220 J2		
○ HD 7/2 DG-10			● VKHB 2162	33021/Q	VKS 6183	25)
			● VKHB 2161	32019 X/Q	VKS 6181	
○ HD 7/2 DG-10			● VKHB 2146	33021/QVB091	VKS 6334	26)
			● VKHB 2161	32019 X/Q		
○ HD 7/5 DG-10			● VKHB 2162	33021/Q	VKS 6183	25)
			● VKHB 2161	32019 X/Q	VKS 6181	
○ HD 7/5 DG-10			● VKHB 2146	33021/QVB091	VKS 6334	26)
			● VKHB 2161	32019 X/Q		
○ HL 4/038 D-12, HL 4/039 DL-12, HL 4/039 D-12, HL 4/06 DL-12, HL 4/06 D-12	VKBA 5056	VKA 4110	● VKHB 2124	33020/Q	VKS 6176	
			● VKHB 2158	33117/Q		
○ HL 7/015 DL-13			● VKHB 2163	33022	VKS 6183	25)
			● VKHB 2164	30220 J2	VKS 6181	
○ HL 7/015 DL-13			● VKHB 2163	33022	VKS 6334	26)
			● VKHB 2164	30220 J2		
○ HL 7/015 D-13			● VKHB 2163	33022	VKS 6183	25)
			● VKHB 2164	30220 J2	VKS 6181	
○ HL 7/015 D-13			● VKHB 2163	33022	VKS 6334	26)
			● VKHB 2164	30220 J2		
○ HL 7/021 D-10			● VKHB 2162	33021/Q	VKS 6183	25)
			● VKHB 2161	32019 X/Q	VKS 6181	
○ HL 7/021 D-10			● VKHB 2146	33021/QVB091	VKS 6334	26)
			● VKHB 2161	32019 X/Q		
○ HL 7/ 024 DL- 12.3.HL 7/ 024 D-12.3.HL 7/ 025 D-12.3			● VKHB 2162	33021/Q	VKS 6183	
			● VKHB 2082	33019/Q	VKS 6181	
○ HL 7/07 DL-10			● VKHB 2162	33021/Q	VKS 6183	25)
			● VKHB 2161	32019 X/Q	VKS 6181	
○ HL 7/07 DL-10			● VKHB 2146	33021/QVB091	VKS 6334	26)
			● VKHB 2161	32019 X/Q		
○ HL 7/07 DL-11.5			● VKHB 2162	33021/Q	VKS 6183	25)
			● VKHB 2161	32019 X/Q	VKS 6181	
○ HL 7/07 DL-11.5			● VKHB 2146	33021/QVB091	VKS 6334	26)
			● VKHB 2161	32019 X/Q		
○ HL 7/07 D-10			● VKHB 2162	33021/Q	VKS 6183	25)
			● VKHB 2161	32019 X/Q	VKS 6181	
○ HL 7/07 D-10			● VKHB 2146	33021/QVB091	VKS 6334	26)
			● VKHB 2161	32019 X/Q		
○ HL 7/07 D-11.5			● VKHB 2162	33021/Q	VKS 6183	25)
			● VKHB 2161	32019 X/Q	VKS 6181	
○ HL 7/07 D-11.5			● VKHB 2146	33021/QVB091	VKS 6334	26)
			● VKHB 2161	32019 X/Q		



	○	HL 7/07 D-11.5			●	VKHB 2162	33021/Q	VKS 6183	25)
					●	VKHB 2161	32019 X/Q	VKS 6181	
	○	HL 7/07 D-11.5			●	VKHB 2146	33021/QVB091	VKS 6334	26)
					●	VKHB 2161	32019 X/Q		
	○	HL 7/26 DL-12.3			●	VKHB 2162	33021/Q	VKS 6183	25)
					●	VKHB 2161	32019 X/Q	VKS 6181	
	○	HL 7/26 DL-12.3			●	VKHB 2146	33021/QVB091	VKS 6334	26)
					●	VKHB 2161	32019 X/Q		
	○	HL 7/26 DL-12.3, HL 7/26 D-12.3			●	VKHB 2162	33021/Q	VKS 6183	
					●	VKHB 2082	33019/Q	VKS 6181	
	○	HL 7/3 D-10			●	VKHB 2162	33021/Q	VKS 6183	25)
					●	VKHB 2161	32019 X/Q	VKS 6181	
	○	HL 7/3 D-10			●	VKHB 2146	33021/QVB091	VKS 6334	26)
					●	VKHB 2161	32019 X/Q		
	○	HL 7/4 D-10			●	VKHB 2162	33021/Q	VKS 6183	25)
					●	VKHB 2161	32019 X/Q	VKS 6181	
	○	HL 7/4 D-10			●	VKHB 2146	33021/QVB091	VKS 6334	26)
					●	VKHB 2161	32019 X/Q		
	○	NR 4/11 DL-7.5	VKBA 5038	VKA 4094	●	VKHB 2071	332330 B/Q	VKS 6158	
					●	VKHB 2070	32310 J2/Q	VKS 6146	
	○	NS 4/10 D-6.7			●	VKHB 2071	332330 B/Q	VKS 6158	
					●	VKHB 2068	33210/Q	VKS 6146	
	○	NS 4/11 D-10	VKBA 5052		●	VKHB 2082	33019/Q	VKS 6154	
					●	VKHB 2028	33215/Q		
SK, 2500 Ser.	●	VD 4/26 DL-7.5	VKBA 5039		●	VKHB 2072	32314 J2/Q	VKS 6150	
					●	VKHB 2070	32310 J2/Q		
	●	VL 4/10 D-7	VKBA 5038	VKA 4094	●	VKHB 2071	332330 B/Q	VKS 6158	
					●	VKHB 2070	32310 J2/Q	VKS 6146	
	●	VL 4/16 D-7.5	VKBA 5039		●	VKHB 2072	32314 J2/Q	VKS 6150	
					●	VKHB 2070	32310 J2/Q		
	●	VL 4/23 D-6.7, VL 4/24 D-6.7, VL 4/25 DL-6.7	VKBA 5038	VKA 4094	●	VKHB 2071	332330 B/Q	VKS 6158	
					●	VKHB 2070	32310 J2/Q	VKS 6146	
	●	VL 4/27 D-7.5	VKBA 5039		●	VKHB 2072	32314 J2/Q	VKS 6150	
					●	VKHB 2070	32310 J2/Q		
	●	VL 4/28 D-7.5	VKBA 5038	VKA 4094	●	VKHB 2071	332330 B/Q	VKS 6158	
					●	VKHB 2070	32310 J2/Q	VKS 6146	
	●	VL 4/28 D-7.5, VL 4/29 D-7.5, VL 4/30 DL-7.5, VL 4/30 D-7.5	VKBA 5039		●	VKHB 2072	32314 J2/Q	VKS 6150	
					●	VKHB 2070	32310 J2/Q		
	●	VL 4/31 DL-7.5	VKBA 5038	VKA 4094	●	VKHB 2071	332330 B/Q	VKS 6158	
					●	VKHB 2070	32310 J2/Q	VKS 6146	
	●	VL 4/31 DL-7.5	VKBA 5039		●	VKHB 2072	32314 J2/Q	VKS 6150	
					●	VKHB 2070	32310 J2/Q		
	●	VL 4/36 D-6.7	VKBA 5038	VKA 4094	●	VKHB 2071	332330 B/Q	VKS 6158	
					●	VKHB 2070	32310 J2/Q	VKS 6146	
	●	VL 5/1 D-9, VL 5/2 D-9			●	VKHB 2203	JH415647- 99401		
					●	VKHB 2002	32311 J2		





MERCEDES-BENZ

.../...

● VL 5/21 DC-9		VKA 4095	● VKHB 2002 32311 J2	VKS 6150
○ HD 4/02 GD-10, HD 4/03 D-10	VKBA 5056	VKA 4110	● VKHB 2002 32311 J2	
○ HD 4/21 DG-10, HD 4/22 D-10	VKBA 5052		● VKHB 2124 33020/Q	VKS 6176
			● VKHB 2158 33117/Q	
○ HD 7/016 DG-13			● VKHB 2082 33019/Q	VKS 6154
			● VKHB 2028 33215/Q	
○ HD 7/016 DG-13			● VKHB 2163 33022	VKS 6183 25)
			● VKHB 2164 30220 J2	VKS 6181
○ HD 7/09 DG-10			● VKHB 2163 33022	VKS 6334 26)
			● VKHB 2164 30220 J2	
○ HD 7/09 DG-10			● VKHB 2162 33021/Q	VKS 6183 25)
			● VKHB 2161 32019 X/Q	VKS 6181
○ HD 7/09 DG-10			● VKHB 2146 33021/QVB091	VKS 6334 26)
			● VKHB 2161 32019 X/Q	
○ HD 7/19 DG-13			● VKHB 2163 33022	VKS 6183 25)
			● VKHB 2164 30220 J2	VKS 6181
○ HD 7/19 DG-13			● VKHB 2163 33022	VKS 6334 26)
			● VKHB 2164 30220 J2	
○ HD 7/2 DG-10			● VKHB 2162 33021/Q	VKS 6183 25)
			● VKHB 2161 32019 X/Q	VKS 6181
○ HD 7/2 DG-10			● VKHB 2146 33021/QVB091	VKS 6334 26)
			● VKHB 2161 32019 X/Q	
○ HD 7/4 D-10/ 3, 978			● VKHB 2162 33021/Q	VKS 6183 25)
			● VKHB 2161 32019 X/Q	VKS 6181
○ HD 7/4 D-10/ 3, 978			● VKHB 2146 33021/QVB091	VKS 6334 26)
			● VKHB 2161 32019 X/Q	
○ HD 7/5 DG-10			● VKHB 2162 33021/Q	VKS 6183 25)
			● VKHB 2161 32019 X/Q	VKS 6181
○ HD 7/5 DG-10			● VKHB 2146 33021/QVB091	VKS 6334 26)
			● VKHB 2161 32019 X/Q	
○ HD 7/5 DG-10/ 3, 978			● VKHB 2162 33021/Q	VKS 6183 25)
			● VKHB 2161 32019 X/Q	VKS 6181
○ HD 7/5 DG-10/ 3, 978			● VKHB 2146 33021/QVB091	VKS 6334 26)
			● VKHB 2161 32019 X/Q	
○ HL 4/038 D-12, HL 4/039 DL-12, HL 4/039 D-12, HL 4/06 DL-12, HL 4/06 D-12	VKBA 5056	VKA 4110	● VKHB 2124 33020/Q	VKS 6176
			● VKHB 2158 33117/Q	
○ HL 7/015 DL-13			● VKHB 2163 33022	VKS 6183 25)
			● VKHB 2164 30220 J2	VKS 6181
○ HL 7/015 DL-13			● VKHB 2163 33022	VKS 6334 26)
			● VKHB 2164 30220 J2	
○ HL 7/015 D-13			● VKHB 2163 33022	VKS 6183 25)
			● VKHB 2164 30220 J2	VKS 6181
○ HL 7/015 D-13			● VKHB 2163 33022	VKS 6334 26)
			● VKHB 2164 30220 J2	



○ HL 7/ 024 DL-12.3, HL 7/024 D-12.3, HL 7/025 D-12.3			● VKHB 2162 33021/Q VKHB 2082 33019/Q	VKS 6183 VKS 6181	
○ HL 7/07 DL-10			● VKHB 2162 33021/Q VKHB 2161 32019 X/Q	VKS 6183 VKS 6181	25)
○ HL 7/07 DL-10			● VKHB 2146 33021/QVB091 VKHB 2161 32019 X/Q	VKS 6334	26)
○ HL 7/07 DL-11.5			● VKHB 2162 33021/Q VKHB 2161 32019 X/Q	VKS 6183 VKS 6181	25)
○ HL 7/07 DL-11.5			● VKHB 2163 33022 VKHB 2164 30220 J2	VKS 6183 VKS 6181	25)
○ HL 7/07 DL-11.5			● VKHB 2146 33021/QVB091 VKHB 2161 32019 X/Q	VKS 6334	26)
○ HL 7/07 DL-11.5			● VKHB 2163 33022 VKHB 2164 30220 J2	VKS 6334	26)
○ HL 7/07 D-10			● VKHB 2162 33021/Q VKHB 2161 32019 X/Q	VKS 6183 VKS 6181	25)
○ HL 7/07 D-10			● VKHB 2146 33021/QVB091 VKHB 2161 32019 X/Q	VKS 6334	26)
○ HL 7/07 D-11.5			● VKHB 2162 33021/Q VKHB 2161 32019 X/Q	VKS 6183 VKS 6181	25)
○ HL 7/07 D-11.5			● VKHB 2146 33021/QVB091 VKHB 2161 32019 X/Q	VKS 6334	26)
○ HL 7/07 D-11.5			● VKHB 2162 33021/Q VKHB 2161 32019 X/Q	VKS 6183 VKS 6181	25)
○ HL 7/07 D-11.5			● VKHB 2146 33021/QVB091 VKHB 2161 32019 X/Q	VKS 6334	26)
○ HL 7/15 D-13			● VKHB 2163 33022 VKHB 2164 30220 J2	VKS 6183 VKS 6181	25)
○ HL 7/15 D-13			● VKHB 2163 33022 VKHB 2164 30220 J2	VKS 6334	26)
○ HL 7/18 D-13			● VKHB 2163 33022 VKHB 2164 30220 J2	VKS 6183 VKS 6181	25)
○ HL 7/18 D-13			● VKHB 2163 33022 VKHB 2164 30220 J2	VKS 6334	26)
○ HL 7/26 DL-12.3, HL 7/26 D-12.3			● VKHB 2162 33021/Q VKHB 2082 33019/Q	VKS 6183 VKS 6181	
○ HL 7/3 D-10			● VKHB 2162 33021/Q VKHB 2161 32019 X/Q	VKS 6183 VKS 6181	25)
○ HL 7/3 D-10			● VKHB 2146 33021/QVB091 VKHB 2161 32019 X/Q	VKS 6334	26)
○ HL 7/4 D-10			● VKHB 2162 33021/Q VKHB 2161 32019 X/Q	VKS 6183 VKS 6181	25)
○ HL 7/4 D-10			● VKHB 2146 33021/QVB091 VKHB 2161 32019 X/Q	VKS 6334	26)
○ NR 4/11 DL-7.5	VKBA 5038	VKA 4094	● VKHB 2071 332330 B/Q VKHB 2070 32310 J2/Q	VKS 6158 VKS 6146	
○ NS 4/10 D-6.7			● VKHB 2071 332330 B/Q VKHB 2068 33210/Q	VKS 6158 VKS 6146	
○ NS 4/11 D-10	VKBA 5052		● VKHB 2082 33019/Q VKHB 2028 33215/Q	VKS 6154	





MERCEDES-BENZ .../...

SK, 2600 Ser.

●	AL 7/1 D-7, AL 7/ 1 D-7.637, AL 7/ 1 D-7.769, AL 7/ 1 D-7/5.217			●	VKHB 2172 331974 A/Q VKHB 2161 32019 X/Q	VKS 6194
●	VD 4/14 DL-7	VKBA 5038	VKA 4094	●	VKHB 2071 332330 B/Q VKHB 2070 32310 J2/Q	VKS 6158 VKS 6146
●	VD 4/20 DL-7.5, VD 4/26 DL-7.5	VKBA 5039		●	VKHB 2072 32314 J2/Q VKHB 2070 32310 J2/Q	VKS 6150
●	VL 4/10 D-7			●	VKHB 2071 332330 B/Q VKHB 2068 33210/Q	VKS 6158 VKS 6146
●	VL 4/10 D-7			●	VKHB 2071 332330 B/Q VKHB 2068 33210/Q	VKS 6158 13) VKS 6146
●	VL 4/10 D-7	VKBA 5038	VKA 4094	●	VKHB 2071 332330 B/Q VKHB 2070 32310 J2/Q	VKS 6158 VKS 6146
●	VL 4/10 D-7	VKBA 5038	VKA 4094	●	VKHB 2071 332330 B/Q VKHB 2070 32310 J2/Q	VKS 6158 14) VKS 6146
●	VL 4/15 D-7.5, VL 4/16 D-7.5, VL 4/19 D-7.5	VKBA 5039		●	VKHB 2072 32314 J2/Q VKHB 2070 32310 J2/Q	VKS 6150
●	VL 4/2 D-7			●	VKHB 2070 32310 J2/Q	
●	VL 4/23 D-6.7, VL 4/24 D-6.7, VL 4/25 DL-6.7	VKBA 5038	VKA 4094	●	VKHB 2071 332330 B/Q VKHB 2070 32310 J2/Q	VKS 6158 VKS 6146
●	VL 4/27 D-7.5, VL 4/28 D-7.5, VL 4/29 D-7.5, VL 4/31 DL-7.5	VKBA 5039		●	VKHB 2072 32314 J2/Q VKHB 2070 32310 J2/Q	VKS 6150
●	VL 4/7 D-7			●	VKHB 2071 332330 B/Q VKHB 2068 33210/Q	VKS 6158 13) VKS 6146
●	VL 4/7 D-7	VKBA 5038	VKA 4094	●	VKHB 2071 332330 B/Q VKHB 2070 32310 J2/Q	VKS 6158 14) VKS 6146
●	VL 4/8 D-7			●	VKHB 2071 332330 B/Q VKHB 2068 33210/Q	VKS 6158 VKS 6146
●	VL 4/9 D-7			●	VKHB 2071 332330 B/Q VKHB 2068 33210/Q	VKS 6158 13) VKS 6146
●	VL 4/9 D-7	VKBA 5038	VKA 4094	●	VKHB 2071 332330 B/Q VKHB 2070 32310 J2/Q	VKS 6158 VKS 6146
●	VL 4/9 D-7	VKBA 5038	VKA 4094	●	VKHB 2071 332330 B/Q VKHB 2070 32310 J2/Q	VKS 6158 14) VKS 6146
●	VL 5/1 D-9, VL 5/2 D-9			●	VKHB 2203 JH415647- 99401 VKHB 2002 32311 J2	
○	HD 4/02 GD-10, HD 4/03 D-10	VKBA 5056	VKA 4110	●	VKHB 2124 33020/Q VKHB 2158 33117/Q	VKS 6176
○	HD 7/014 DGS-16			●	VKHB 2163 33022 VKHB 2165 33220	VKS 6183 VKS 6181



○ HD 7/016 DG-13	VKBA 5056	VKA 4110	● VKHB 2163	33022	VKS 6183	25)
○ HD 7/016 DG-13			● VKHB 2164	30220 J2	VKS 6181	
○ HD 7/19 DG-13			● VKHB 2163	33022	VKS 6334	26)
○ HD 7/19 DG-13			● VKHB 2164	30220 J2		
○ HD 7/19 DG-13			● VKHB 2163	33022	VKS 6183	25)
○ HD 7/19 DG-13			● VKHB 2164	30220 J2	VKS 6181	
○ HD 7/2 DG-10			● VKHB 2163	33022	VKS 6334	26)
○ HD 7/2 DG-10			● VKHB 2164	30220 J2		
○ HD 7/2 DG-10			● VKHB 2162	33021/Q	VKS 6183	25)
○ HD 7/2 DG-10			● VKHB 2161	32019 X/Q	VKS 6181	
○ HD 7/2 DG-10			● VKHB 2146	33021/QVB091	VKS 6334	26)
○ HD 7/2 DG-10			● VKHB 2161	32019 X/Q		
○ HL 4/01 DL-10			● VKHB 2124	33020/Q	VKS 6176	
○ HL 4/01 DL-10			● VKHB 2158	33117/Q		
○ HL 7/013 D-16			● VKHB 2163	33022	VKS 6183	
○ HL 7/013 D-16			● VKHB 2165	33220	VKS 6181	
○ HL 7/015 DL-13			● VKHB 2163	33022	VKS 6183	25)
○ HL 7/015 DL-13			● VKHB 2164	30220 J2	VKS 6181	
○ HL 7/015 DL-13			● VKHB 2163	33022	VKS 6334	26)
○ HL 7/015 DL-13			● VKHB 2164	30220 J2		
○ HL 7/015 D-13			● VKHB 2163	33022	VKS 6183	25)
○ HL 7/015 D-13			● VKHB 2164	30220 J2	VKS 6181	
○ HL 7/015 D-13			● VKHB 2163	33022	VKS 6334	26)
○ HL 7/015 D-13			● VKHB 2164	30220 J2		
○ HL 7/016 DG-13			● VKHB 2163	33022	VKS 6183	25)
○ HL 7/016 DG-13			● VKHB 2164	30220 J2	VKS 6181	
○ HL 7/016 DG-13			● VKHB 2163	33022	VKS 6334	26)
○ HL 7/016 DG-13			● VKHB 2164	30220 J2		
○ HL 7/07 D-10			● VKHB 2162	33021/Q	VKS 6183	25)
○ HL 7/07 D-10			● VKHB 2161	32019 X/Q	VKS 6181	
○ HL 7/07 D-10			● VKHB 2146	33021/QVB091	VKS 6334	26)
○ HL 7/07 D-10			● VKHB 2161	32019 X/Q		
○ HL 7/18 DS-13	● VKHB 2163	33022	VKS 6183	25)		
○ HL 7/18 DS-13	● VKHB 2164	30220 J2	VKS 6181			
○ HL 7/18 DS-13	● VKHB 2163	33022	VKS 6334	26)		
○ HL 7/18 DS-13	● VKHB 2164	30220 J2				
○ HL 7/18 D-13	● VKHB 2163	33022	VKS 6183	25)		
○ HL 7/18 D-13	● VKHB 2164	30220 J2	VKS 6181			
○ HL 7/18 D-13	● VKHB 2163	33022	VKS 6334	26)		
○ HL 7/18 D-13	● VKHB 2164	30220 J2				
○ HL 7/1-10	● VKHB 2162	33021/Q	VKS 6183	25)		
○ HL 7/1-10	● VKHB 2161	32019 X/Q	VKS 6181			
○ HL 7/1-10	● VKHB 2146	33021/QVB091	VKS 6334	26)		
○ HL 7/1-10	● VKHB 2161	32019 X/Q				
○ HL 7/3 D-10	● VKHB 2051	33213/Q	VKS 6157	26)		
○ HL 7/3 D-10	● VKHB 2065	33208/Q				
○ HL 7/3 D-10	● VKHB 2162	33021/Q	VKS 6183	25)		
○ HL 7/3 D-10	● VKHB 2161	32019 X/Q	VKS 6181			
○ HL 7/3 D-10	● VKHB 2146	33021/QVB091	VKS 6334	26)		
○ HL 7/3 D-10	● VKHB 2161	32019 X/Q				
○ HL7/015 D-13	● VKHB 2163	33022	VKS 6183	25)		
○ HL7/015 D-13	● VKHB 2164	30220 J2	VKS 6181			





MERCEDES-BENZ

.../...

	○	HL7/015 D-13			●	VKHB 2163 VKHB 2164	33022 30220 J2	VKS 6334	26)
SK, 2800 Ser.	●	VD 4/20 DL-7.5			●	VKHB 2071 VKHB 2068	332330 B/Q 33210/Q	VKS 6158 VKS 6146	
	●	VL 4/10 D-7	VKBA 5038	VKA 4094	●	VKHB 2071 VKHB 2070	332330 B/Q 32310 J2/Q	VKS 6158 VKS 6146	
	●	VL 4/16 D-7.5	VKBA 5039		●	VKHB 2072 VKHB 2070	32314 J2/Q 32310 J2/Q	VKS 6150	
SK, 3000 Ser.	●	VD 4/20 DL-7.5			●	VKHB 2071 VKHB 2068	332330 B/Q 33210/Q	VKS 6158 VKS 6146	
	●	VD 4/20 DL-7.5	VKBA 5039		●	VKHB 2072 VKHB 2070	32314 J2/Q 32310 J2/Q	VKS 6150	
	●	VL 4/10 D-7	VKBA 5038	VKA 4094	●	VKHB 2071 VKHB 2070	332330 B/Q 32310 J2/Q	VKS 6158 VKS 6146	
	●	VL 4/15 D-7.5, VL 4/16 D-7.5, VL 4/27 D-7.5	VKBA 5039		●	VKHB 2072 VKHB 2070	32314 J2/Q 32310 J2/Q	VKS 6150	
	●	VL 4/9 D-7	VKBA 5038	VKA 4094	●	VKHB 2071 VKHB 2070	332330 B/Q 32310 J2/Q	VKS 6158 VKS 6146	
	●	VL 5/2 D-9			●	VKHB 2203	JH415647- 99401		
	○	HD 7/014 DGS-16			●	VKHB 2002	32311 J2		
	○	HD 7/016 DG-13			●	VKHB 2163 VKHB 2165	33022 33220	VKS 6183 VKS 6181	
	○	HD 7/016 DG-13			●	VKHB 2163 VKHB 2164	33022 30220 J2	VKS 6183 VKS 6181	25)
	○	HD 7/016 DG-13			●	VKHB 2163 VKHB 2164	33022 30220 J2	VKS 6334	26)
	○	HD 7/2 DG-10			●	VKHB 2162 VKHB 2161	33021/Q 32019 X/Q	VKS 6183 VKS 6181	25)
	○	HD 7/2 DG-10			●	VKHB 2146 VKHB 2161	33021/QVB091 32019 X/Q	VKS 6334	26)
	○	HD 7/5 DG-10			●	VKHB 2162 VKHB 2161	33021/Q 32019 X/Q	VKS 6183 VKS 6181	25)
	○	HD 7/5 DG-10			●	VKHB 2146 VKHB 2161	33021/QVB091 32019 X/Q	VKS 6334	26)
	○	HL 7/013 D-16			●	VKHB 2163 VKHB 2165	33022 33220	VKS 6183 VKS 6181	
	○	HL 7/015 D-13			●	VKHB 2163 VKHB 2164	33022 30220 J2	VKS 6183 VKS 6181	25)
	○	HL 7/015 D-13			●	VKHB 2163 VKHB 2164	33022 30220 J2	VKS 6334	26)
	○	HL 7/3 D-10			●	VKHB 2162 VKHB 2161	33021/Q 32019 X/Q	VKS 6183 VKS 6181	25)
	○	HL 7/3 D-10			●	VKHB 2146 VKHB 2161	33021/QVB091 32019 X/Q	VKS 6334	26)
	○	HL 7/4 D-10			●	VKHB 2162 VKHB 2161	33021/Q 32019 X/Q	VKS 6183 VKS 6181	25)



	○	HL 7/4 D-10			●	VKHB 2146 VKHB 2161	33021/QVB091 32019 X/Q	VKS 6334	26)
SK, 3200 Ser.	●	AL 7/1 D-7			●	VKHB 2172 VKHB 2161	331974 A/Q 32019 X/Q	VKS 6194	
	●	VD 4/20 DL-7.5	VKBA 5039		●	VKHB 2072 VKHB 2070	32314 J2/Q 32310 J2/Q	VKS 6150	
	●	VL 4/10 D-7	VKBA 5038	VKA 4094	●	VKHB 2071 VKHB 2070	332330 B/Q 32310 J2/Q	VKS 6158 VKS 6146	
	●	VL 4/15 D-7.5, VL 4/16 D-7.5	VKBA 5039		●	VKHB 2072 VKHB 2070	32314 J2/Q 32310 J2/Q	VKS 6150	
	●	VL 4/23 D-6.7, VL 4/24 D-6.7, VL 4/25 DL-6.7	VKBA 5038	VKA 4094	●	VKHB 2071 VKHB 2070	332330 B/Q 32310 J2/Q	VKS 6158 VKS 6146	
	●	VL 4/27 D-7.5, VL 4/28 D-7.5, VL 4/29 D-7.5, VL 4/30 DL-7.5, VL 4/30 D-7.5, VL 4/31 DL-7.5	VKBA 5039		●	VKHB 2072 VKHB 2070	32314 J2/Q 32310 J2/Q	VKS 6150	
	○	HD 7/ 014 DGS-16, HD 7/014 DG-16			●	VKHB 2163 VKHB 2165	33022 33220	VKS 6183 VKS 6181	
	○	HD 7/016 DG-13			●	VKHB 2163 VKHB 2164	33022 30220 J2	VKS 6183 VKS 6181	25)
	○	HD 7/016 DG-13			●	VKHB 2163 VKHB 2164	33022 30220 J2	VKS 6334	26)
	○	HD 7/19 DG-13			●	VKHB 2163 VKHB 2164	33022 30220 J2	VKS 6183 VKS 6181	25)
	○	HD 7/19 DG-13			●	VKHB 2163 VKHB 2164	33022 30220 J2	VKS 6334	26)
	○	HD 7/2 DG-10			●	VKHB 2162 VKHB 2161	33021/Q 32019 X/Q	VKS 6183 VKS 6181	25)
	○	HD 7/2 DG-10			●	VKHB 2146 VKHB 2161	33021/QVB091 32019 X/Q	VKS 6334	26)
	○	HD 7/5 DG-10			●	VKHB 2162 VKHB 2161	33021/Q 32019 X/Q	VKS 6183 VKS 6181	25)
	○	HD 7/5 DG-10			●	VKHB 2146 VKHB 2161	33021/QVB091 32019 X/Q	VKS 6334	26)
	○	HL 4/06 D-12	VKBA 5056	VKA 4110	●	VKHB 2124 VKHB 2158	33020/Q 33117/Q	VKS 6176	
	○	HL 7/013 D-16			●	VKHB 2163 VKHB 2165	33022 33220	VKS 6183 VKS 6181	
	○	HL 7/015 DL-13			●	VKHB 2163 VKHB 2164	33022 30220 J2	VKS 6183 VKS 6181	25)
	○	HL 7/015 DL-13			●	VKHB 2163 VKHB 2164	33022 30220 J2	VKS 6334	26)
	○	HL 7/015 D-13			●	VKHB 2163 VKHB 2164	33022 30220 J2	VKS 6183 VKS 6181	25)
	○	HL 7/015 D-13			●	VKHB 2163 VKHB 2164	33022 30220 J2	VKS 6334	26)





MERCEDES-BENZ .../...

○ HL 7/18 D-13			● VKHB 2163 33022	VKS 6183 25)
			● VKHB 2164 30220 J2	VKS 6181
○ HL 7/18 D-13			● VKHB 2163 33022	VKS 6334 26)
			● VKHB 2164 30220 J2	
○ HL 7/3 D-10			● VKHB 2162 33021/Q	VKS 6183 25)
			● VKHB 2161 32019 X/Q	VKS 6181
○ HL 7/3 D-10			● VKHB 2146 33021/QVB091	VKS 6334 26)
			● VKHB 2161 32019 X/Q	
○ HL 7/4 D-10			● VKHB 2162 33021/Q	VKS 6183 25)
			● VKHB 2161 32019 X/Q	VKS 6181
○ HL 7/4 D-10			● VKHB 2146 33021/QVB091	VKS 6334 26)
			● VKHB 2161 32019 X/Q	
○ NR 4/11 DL-7.5	VKBA 5038	VKA 4094	● VKHB 2071 332330 B/Q	VKS 6158
			● VKHB 2070 32310 J2/Q	VKS 6146
○ NS 4/11 D-10	VKBA 5052		● VKHB 2082 33019/Q	VKS 6154
			● VKHB 2028 33215/Q	

SK, 3300 Ser.	● AL 7/1 D-7		● VKHB 2172 331974 A/Q	VKS 6194
			● VKHB 2161 32019 X/Q	
	● VD 4/20 DL-7.5		● VKHB 2071 332330 B/Q	VKS 6158
			● VKHB 2068 33210/Q	VKS 6146
	● VD 4/20 DL-7.5	VKBA 5039	● VKHB 2072 32314 J2/Q	VKS 6150
			● VKHB 2070 32310 J2/Q	
	● VL 4/10 D-7	VKBA 5038	● VKHB 2071 332330 B/Q	VKS 6158
		VKA 4094	● VKHB 2070 32310 J2/Q	VKS 6146
	● VL 4/15 D-7.5, VL 4/16 D-7.5, VL 4/27 D-7.5	VKBA 5039	● VKHB 2072 32314 J2/Q	VKS 6150
			● VKHB 2070 32310 J2/Q	
	● VL 5/1 D-9		● VKHB 2002 32311 J2	VKS 6150
		VKA 4095	● VKHB 2002 32311 J2	
	● VL 5/2 D-9		● VKHB 2203 JH415647-99401	
			● VKHB 2002 32311 J2	
	● VL 5/20 DC-9, VL 5/21 DC-9		● VKHB 2002 32311 J2	VKS 6150
		VKA 4095	● VKHB 2002 32311 J2	
	○ HD 7/016 DG-13		● VKHB 2163 33022	VKS 6183 25)
			● VKHB 2164 30220 J2	VKS 6181
	○ HD 7/016 DG-13		● VKHB 2163 33022	VKS 6334 26)
			● VKHB 2164 30220 J2	
○ HD 7/19 DG-13		● VKHB 2163 33022	VKS 6183 25)	
		● VKHB 2164 30220 J2	VKS 6181	
○ HD 7/19 DG-13		● VKHB 2163 33022	VKS 6334 26)	
		● VKHB 2164 30220 J2		
○ HD 7/2 DG-10		● VKHB 2162 33021/Q	VKS 6183 25)	
		● VKHB 2161 32019 X/Q	VKS 6181	
○ HD 7/2 DG-10		● VKHB 2146 33021/QVB091	VKS 6334 26)	
		● VKHB 2161 32019 X/Q		
○ HL 7/015 D-13		● VKHB 2163 33022	VKS 6183 25)	
		● VKHB 2164 30220 J2	VKS 6181	
○ HL 7/015 D-13		● VKHB 2163 33022	VKS 6334 26)	
		● VKHB 2164 30220 J2		



	○	HL 7/016 DG-13			●	VKHB 2163	33022	VKS 6183	25)
					●	VKHB 2164	30220 J2	VKS 6181	
	○	HL 7/016 DG-13			●	VKHB 2163	33022	VKS 6334	26)
					●	VKHB 2164	30220 J2		
	○	HL 7/18 D-13			●	VKHB 2163	33022	VKS 6183	25)
					●	VKHB 2164	30220 J2	VKS 6181	
	○	HL 7/18 D-13			●	VKHB 2163	33022	VKS 6334	26)
					●	VKHB 2164	30220 J2		
	○	HL 7/3 D-10			●	VKHB 2162	33021/Q	VKS 6183	25)
					●	VKHB 2161	32019 X/Q	VKS 6181	
	○	HL 7/3 D-10			●	VKHB 2146	33021/QVB091	VKS 6334	26)
					●	VKHB 2161	32019 X/Q		

SK, 3500 Ser.

●		AL 7/1 D-7			●	VKHB 2172	331974 A/Q		
					●	VKHB 2161	32019 X/Q	VKS 6194	
●		VD 4/20 DL-7.5	VKBA 5039		●	VKHB 2072	32314 J2/Q	VKS 6150	
					●	VKHB 2070	32310 J2/Q		
●		VL 4/10 D-7	VKBA 5038	VKA 4094	●	VKHB 2071	332330 B/Q	VKS 6158	
					●	VKHB 2070	32310 J2/Q	VKS 6146	
●		VL 4/15 D-7.5, VL 4/16 D-7.5	VKBA 5039		●	VKHB 2072	32314 J2/Q	VKS 6150	
					●	VKHB 2070	32310 J2/Q		
●		VL 4/23 D-6.7, VL 4/24 D-6.7, VL 4/25 DL-6.7	VKBA 5038	VKA 4094	●	VKHB 2071	332330 B/Q	VKS 6158	
					●	VKHB 2070	32310 J2/Q	VKS 6146	
●		VL 4/27 D-7.5, VL 4/28 D-7.5, VL 4/29 D-7.5, VL 4/31 DL-7.5	VKBA 5039		●	VKHB 2072	32314 J2/Q	VKS 6150	
					●	VKHB 2070	32310 J2/Q		
●		VL 5/1 D-9, VL 5/2 D-9			●	VKHB 2203			
							JH415647-994 01		
●		VO 4/22 DLE-6.6	VKBA 5038	VKA 4094	●	VKHB 2002	32311 J2		
					●	VKHB 2071	332330 B/Q	VKS 6158	
					●	VKHB 2070	32310 J2/Q	VKS 6146	
○		HD 7/014 DGS-16			●	VKHB 2163	33022	VKS 6183	
					●	VKHB 2165	33220	VKS 6181	
○		HD 7/016 DG-13			●	VKHB 2163	33022	VKS 6183	25)
					●	VKHB 2164	30220 J2	VKS 6181	
○		HD 7/016 DG-13			●	VKHB 2163	33022	VKS 6334	26)
					●	VKHB 2164	30220 J2		
○		HD 7/19 DG-13			●	VKHB 2163	33022	VKS 6183	25)
					●	VKHB 2164	30220 J2	VKS 6181	
○		HD 7/19 DG-13			●	VKHB 2163	33022	VKS 6334	26)
					●	VKHB 2164	30220 J2		
○		HL 7/013 D-16			●	VKHB 2163	33022	VKS 6183	25)
					●	VKHB 2165	33220	VKS 6181	
○		HL 7/015 DL-13			●	VKHB 2163	33022	VKS 6183	25)
					●	VKHB 2164	30220 J2	VKS 6181	
○		HL 7/015 DL-13			●	VKHB 2163	33022	VKS 6334	26)
					●	VKHB 2164	30220 J2		
○		HL 7/015 D-13			●	VKHB 2163	33022	VKS 6183	25)
					●	VKHB 2164	30220 J2	VKS 6181	





MERCEDES-BENZ .../...

	○	HL 7/015 D-13			●	VKHB 2163	33022	VKS 6334	26)
					●	VKHB 2164	30220 J2		
	○	HL 7/016 DG-13			●	VKHB 2163	33022	VKS 6183	25)
					●	VKHB 2164	30220 J2	VKS 6181	
	○	HL 7/016 DG-13			●	VKHB 2163	33022	VKS 6334	26)
					●	VKHB 2164	30220 J2		
	○	HL 7/18 D-13			●	VKHB 2163	33022	VKS 6183	25)
					●	VKHB 2164	30220 J2	VKS 6181	
	○	HL 7/18 D-13			●	VKHB 2163	33022	VKS 6334	26)
					●	VKHB 2164	30220 J2		
	○	NR 4/11 DL-7.5	VKBA 5038	VKA 4094	●	VKHB 2071	332330 B/Q	VKS 6158	
					●	VKHB 2070	32310 J2/Q	VKS 6146	
SK, 3600 Ser.	●	VD 4/20 DL-7.5	VKBA 5039		●	VKHB 2072	32314 J2/Q	VKS 6150	
					●	VKHB 2070	32310 J2/Q		
	●	VL 4/10 D-7	VKBA 5038	VKA 4094	●	VKHB 2071	332330 B/Q	VKS 6158	
					●	VKHB 2070	32310 J2/Q	VKS 6146	
	●	VL 4/16 D-7.5	VKBA 5039		●	VKHB 2072	32314 J2/Q	VKS 6150	
					●	VKHB 2070	32310 J2/Q		
	○	HD 7/19 DG-13			●	VKHB 2163	33022	VKS 6183	25)
					●	VKHB 2164	30220 J2	VKS 6181	
	○	HD 7/19 DG-13			●	VKHB 2163	33022	VKS 6334	26)
					●	VKHB 2164	30220 J2		
SK, 3800 Ser.	●	VD 4/20 DL-7.5, VL 4/16 D-7.5	VKBA 5039		●	VKHB 2072	32314 J2/Q	VKS 6150	
					●	VKHB 2070	32310 J2/Q		
	○	HD 7/ 014 DGS-16, HD 7/014 DG-16, HL 7/013 D-16			●	VKHB 2163	33022	VKS 6183	
					●	VKHB 2165	33220	VKS 6181	
SK, 4000 Ser.	●	VL 4/10 D-7	VKBA 5038	VKA 4094	●	VKHB 2071	332330 B/Q	VKS 6158	
					●	VKHB 2070	32310 J2/Q	VKS 6146	
	●	VL 4/16 D-7.5	VKBA 5039		●	VKHB 2072	32314 J2/Q	VKS 6150	
					●	VKHB 2070	32310 J2/Q		
	○	HD 7/014 DGS-16			●	VKHB 2163	33022	VKS 6183	
					●	VKHB 2165	33220	VKS 6181	
	○	HD 7/016 DG-13			●	VKHB 2163	33022	VKS 6183	25)
					●	VKHB 2164	30220 J2	VKS 6181	
	○	HD 7/016 DG-13			●	VKHB 2163	33022	VKS 6334	26)
					●	VKHB 2164	30220 J2		
	○	HL 7/013 D-16			●	VKHB 2163	33022	VKS 6183	
					●	VKHB 2165	33220	VKS 6181	
	○	HL 7/015 D-13			●	VKHB 2163	33022	VKS 6183	25)
					●	VKHB 2164	30220 J2	VKS 6181	
	○	HL 7/015 D-13			●	VKHB 2163	33022	VKS 6334	26)
					●	VKHB 2164	30220 J2		



SK, 4100 Ser.

●	VL 4/27 D-7.5, VL 4/53 DC-7.5, VL 4/55 D-7.5	VKBA 5039		●	VKHB 2072 VKHB 2070	32314 J2/Q 32310 J2/Q	VKS 6150	24)
●	VL 5/1 D-9		VKA 4095	●	VKHB 2002 VKHB 2002	32311 J2 32311 J2	VKS 6150	
○	HD 4/02 GD-10, HD 4/03 D-10	VKBA 5056	VKA 4110	●	VKHB 2124 VKHB 2158	33020/Q 33117/Q	VKS 6176	
○	HD 7/016 DG-13			●	VKHB 2163 VKHB 2164	33022 30220 J2	VKS 6183 VKS 6181	25)
○	HD 7/016 DG-13			●	VKHB 2163 VKHB 2164	33022 30220 J2	VKS 6334	26)
○	HL 7/015 DL-13			●	VKHB 2163 VKHB 2164	33022 30220 J2	VKS 6183 VKS 6181	25)
○	HL 7/015 DL-13			●	VKHB 2163 VKHB 2164	33022 30220 J2	VKS 6334	26)

SK, 4400 Ser.

●	AL 7/1 D-7			●	VKHB 2172 VKHB 2161	331974 A/Q 32019 X/Q	VKS 6194	
●	VL 4/10 D-7	VKBA 5038	VKA 4094	●	VKHB 2071 VKHB 2070	332330 B/Q 32310 J2/Q	VKS 6158 VKS 6146	
●	VL 4/15 D-7.5, VL 4/16 D-7.5	VKBA 5039		●	VKHB 2072 VKHB 2070	32314 J2/Q 32310 J2/Q	VKS 6150	
●	VL 4/25 DL-6.7	VKBA 5038	VKA 4094	●	VKHB 2071 VKHB 2070	332330 B/Q 32310 J2/Q	VKS 6158 VKS 6146	
●	VL 4/27 D-7.5, VL 4/28 D-7.5	VKBA 5039		●	VKHB 2072 VKHB 2070	32314 J2/Q 32310 J2/Q	VKS 6150	
●	VL 5/1 D-9			●	VKHB 2203	JH415647- 99401		
●	VL 5/2 D-9			●	VKHB 2002	32311 J2		
○	HD 7/016 DG-13			●	VKHB 2203	JH415647- 99401		
○	HD 7/016 DG-13			●	VKHB 2002	32311 J2		
○	HD 7/016 DG-13			●	VKHB 2163 VKHB 2164	33022 30220 J2	VKS 6183 VKS 6181	25)
○	HD 7/016 DG-13			●	VKHB 2163 VKHB 2164	33022 30220 J2	VKS 6334	26)

SK, 4800 Ser.

●	VL 4/10 D-7	VKBA 5038	VKA 4094	●	VKHB 2071 VKHB 2070	332330 B/Q 32310 J2/Q	VKS 6158 VKS 6146	
●	VL 4/15 D-7.5, VL 4/16 D-7.5, VL 4/27 D-7.5	VKBA 5039		●	VKHB 2072 VKHB 2070	32314 J2/Q 32310 J2/Q	VKS 6150	
●	VL 5/1 D-9, VL 5/2 D-9			●	VKHB 2203	JH415647- 99401		
○	HD 7/016 DG-13			●	VKHB 2002	32311 J2		
○	HD 7/016 DG-13			●	VKHB 2163 VKHB 2164	33022 30220 J2	VKS 6183 VKS 6181	25)
○	HD 7/016 DG-13			●	VKHB 2163 VKHB 2164	33022 30220 J2	VKS 6334	26)



MERCEDES-BENZ .../...

	○	HL 7/015 D-13			●	VKHB 2163	33022	VKS 6183	25)
					●	VKHB 2164	30220 J2	VKS 6181	
	○	HL 7/015 D-13			●	VKHB 2163	33022	VKS 6334	26)
					●	VKHB 2164	30220 J2		
SK, 5000 Ser.	●	VL 4/27 D-7.5	VKBA 5039		●	VKHB 2072	32314 J2/Q	VKS 6150	
					●	VKHB 2070	32310 J2/Q		
	●	VL 4/10 D-7	VKBA 5038	VKA 4094	●	VKHB 2071	332330 B/Q	VKS 6158	
					●	VKHB 2070	32310 J2/Q	VKS 6146	
	●	VL 4/15 D-7.5, VL 4/16 D-7.5	VKBA 5039		●	VKHB 2072	32314 J2/Q	VKS 6150	
					●	VKHB 2070	32310 J2/Q		
	●	VL 4/23 D-6.7, VL 4/24 D-6.7	VKBA 5038	VKA 4094	●	VKHB 2071	332330 B/Q	VKS 6158	
					●	VKHB 2070	32310 J2/Q	VKS 6146	
	●	VL 4/27 D-7.5, VL 4/28 D-7.5	VKBA 5039		●	VKHB 2072	32314 J2/Q	VKS 6150	
					●	VKHB 2070	32310 J2/Q		
	●	VL 5/1 D-9, VL 5/2 D-9			●	VKHB 2203	JH415647-99401		
					●	VKHB 2002	32311 J2		
	○	HD 7/014 DGS-16			●	VKHB 2163	33022	VKS 6183	
					●	VKHB 2165	33220	VKS 6181	
	○	HD 7/016 DG-13			●	VKHB 2163	33022	VKS 6183	25)
					●	VKHB 2164	30220 J2	VKS 6181	
	○	HD 7/016 DG-13			●	VKHB 2163	33022	VKS 6334	26)
					●	VKHB 2164	30220 J2		
	○	HD 7/19 DG-13			●	VKHB 2163	33022	VKS 6183	25)
					●	VKHB 2164	30220 J2	VKS 6181	
	○	HD 7/19 DG-13			●	VKHB 2163	33022	VKS 6334	26)
					●	VKHB 2164	30220 J2		
	○	HL 7/015 DL-13			●	VKHB 2163	33022	VKS 6183	25)
					●	VKHB 2164	30220 J2	VKS 6181	
	○	HL 7/015 DL-13			●	VKHB 2163	33022	VKS 6334	26)
					●	VKHB 2164	30220 J2		
	○	HL 7/18 D-13			●	VKHB 2163	33022	VKS 6183	25)
					●	VKHB 2164	30220 J2	VKS 6181	
	○	HL 7/18 D-13			●	VKHB 2163	33022	VKS 6334	26)
					●	VKHB 2164	30220 J2		
SK, 6000 Ser.	●	VL 4/10 D-7	VKBA 5038	VKA 4094	●	VKHB 2071	332330 B/Q	VKS 6158	
					●	VKHB 2070	32310 J2/Q	VKS 6146	
	●	VL 4/15 D-7.5, VL 4/16 D-7.5	VKBA 5039		●	VKHB 2072	32314 J2/Q	VKS 6150	
					●	VKHB 2070	32310 J2/Q		
ATEGO, 700 Ser.	●	VL 2/21 DC-3.5.			●	VKHB 2318	33111 JR		
					●	VKHB 2317	32306 JR		
	○	HL 2/43 DC-6.2	VKBA 5048	VKA 4103	●	VKHB 2155	331293/Q	VKS 6172	37)
					●	VKHB 2156	33011/Q		



ATEGO, 800 Ser.	●	VL 2/21 DC-3.5	VKBA 5048	VKA 4103	●	VKHB 2318	33111 JR	VKS 6172	37)
	●	VL 2/22 DC-4.1			●	VKHB 2317	32306 JR		
	○	HL 2/43 DC-6.2			●	VKHB 2318	33111 JR		
	○	HL 4/40 DC-7			●	VKHB 2317	32306 JR		
	○	HL 4/40 DC-7			●	VKHB 2155	331293/Q		
	○	HL 4/40 DC-7			●	VKHB 2156	33011/Q		
	○	HL 4/40 DC-7			●	VKHB 2321	33017/Q		
	○	HL 4/40 DC-7			●	VKHB 2044	33014		
○	HL 4/40 DC-7	●	VKHB 2124	33020/Q					
○	HL 4/40 DC-7	●	VKHB 2326	33116/Q					
○	HL 4/40 DC-7	●	VKHB 2082	33019/Q					
○	HL 4/40 DC-7	●	VKHB 2170	32018 X/Q					
○	HL 4/40 DC-7	●	VKHB 2041	580/572/Q					
○	HL 4/40 DC-7	●	VKHB 2328	504376 A					

ATEGO, 900 Ser.	●	VL 2/22 DC-4.1	VKBA 5048	VKA 4103	●	VKHB 2318	33111 JR	VKS 6172	37)
	●	VL 3/21 DC-5.3			●	VKHB 2317	32306 JR		
	●	AL 3/40 D-4.7			●	VKHB 2319	33213 JR		
	○	HL 2/43 DC-6.2			●	VKHB 2320	33208 JR-1/ 33208 J		
	○	HL 4/40 DC-7, HL 4/40 D-7, HL 4/40 DS-7.7			●	VKHB 2321	33017/Q		
	○	HL 4/40 DC-7, HL 4/40 D-7, HL 4/40 DS-7.7			●	VKHB 2155	331293/Q		
	○	HL 4/40 DC-7, HL 4/40 D-7, HL 4/40 DS-7.7			●	VKHB 2156	33011/Q		
	○	HL 4/40 DC-7, HL 4/40 D-7, HL 4/40 DS-7.7			●	VKHB 2321	33017/Q		
	○	HL 4/40 DC-7, HL 4/40 D-7, HL 4/40 DS-7.7			●	VKHB 2044	33014		
	○	HL 4/40 DC-7, HL 4/40 D-7, HL 4/40 DS-7.7			●	VKHB 2124	33020/Q		
○	HL 4/40 DC-7, HL 4/40 D-7, HL 4/40 DS-7.7	●	VKHB 2326	33116/Q					
○	HL 4/40 DC-7, HL 4/40 D-7, HL 4/40 DS-7.7	●	VKHB 2082	33019/Q					
○	HL 4/40 DC-7, HL 4/40 D-7, HL 4/40 DS-7.7	●	VKHB 2170	32018 X/Q					
○	HL 4/40 DC-7, HL 4/40 D-7, HL 4/40 DS-7.7	●	VKHB 2041	580/572/Q					
○	HL 4/40 DC-7, HL 4/40 D-7, HL 4/40 DS-7.7	●	VKHB 2328	504376 A					

ATEGO, 1000 Ser.	●	VL 2/22 DC-4.1	VKBA 5048	VKA 4103	●	VKHB 2318	33111 JR	VKS 6172	37)
	●	VL 3/21 DC-5.3			●	VKHB 2317	32306 JR		
	●	AL 3/40 D-4.7			●	VKHB 2319	33213 JR		
	○	HL 2/43 DC-6.2			●	VKHB 2320	33208 JR-1/ 33208 J		
	○	HL 4/40 DC-7, HL 4/40 D-7, HL 4/40 DS-7.7			●	VKHB 2321	33017/Q		
○	HL 4/40 DC-7, HL 4/40 D-7, HL 4/40 DS-7.7	●	VKHB 2155	331293/Q					
○	HL 4/40 DC-7, HL 4/40 D-7, HL 4/40 DS-7.7	●	VKHB 2156	33011/Q					
○	HL 4/40 DC-7, HL 4/40 D-7, HL 4/40 DS-7.7	●	VKHB 2321	33017/Q					
○	HL 4/40 DC-7, HL 4/40 D-7, HL 4/40 DS-7.7	●	VKHB 2044	33014					



MERCEDES-BENZ

.../...

○ HL 4/40 DC-7,
HL 4/40 D-7,
HL 4/40 DS-7.7

● VKHB 2124 33020/Q
● VKHB 2326 33116/Q VKS 6351 39)

○ HL 4/40 DC-7,
HL 4/40 D-7,
HL 4/40 DS-7.7

● VKHB 2082 33019/Q
● VKHB 2170 32018 X/Q VKS 6352 40)

○ HL 4/40 DC-7,
HL 4/40 D-7,
HL 4/40 DS-7.7

● VKHB 2041 580/572/Q
● VKHB 2328 504376 A VKS 6178 41)

ATEGO, 1200, 1300,
1500 Ser.

- VL 3/21 DC-5.3
- AL 3/40 D-6
- HL 4/40 DC-10.8
- HL 4/40 DC-10.8
- HL 4/40 DC-10.8
- HL 4/40 DC-10.8

- VKHB 2319 33213 JR
 - VKHB 2320 33208 JR-1/
33208 J
 - VKHB 2124 33020/Q
 - VKHB 2169 32017 X/Q
 - VKHB 2321 33017/Q
 - VKHB 2044 33014
 - VKHB 2124 33020/Q
 - VKHB 2326 33116/Q
 - VKHB 2082 33019/Q
 - VKHB 2170 32018 X/Q
 - VKHB 2041 580/572/Q
 - VKHB 2328 504376 A
- VKS 6350 38)
- VKS 6351 39)
- VKS 6352 40)
- VKS 6178 41)

ATEGO, 1800 Ser.

- VL 5/1 D-9
- VL 5/1 D-9
- VL 4/50 DC-7.5,
VL 4/51 DC-7.5,
VL 4/55 D-7.5,
VL 4/56 D-7.5,
VL 4/54 DC-8,
- VL 4/50 DC-7.5,
VL 4/51 DC-7.5,
VL 4/55 D-7.5,
VL 4/56 D-7.5,
VL 4/54 DC-8
- VL 4/50 DC-7.5,
VL 4/51 DC-7.5,
VL 4/55 D-7.5,
VL 4/56 D-7.5,
VL 4/54 DC-8
- VL 5/21 DC-9

VKBA 5039

VKBA 5375

VKA 4095

VKA 4095

- VKHB 2203 JH415647-
99401
 - VKHB 2002 32311 J2
 - VKHB 2002 32311 J2
 - VKHB 2002 32311 J2
 - VKHB 2072 32314 J2/Q
 - VKHB 2070 32310 J2/Q
 - VKHB 2307 801785
 - VKHB 2003 32312 J2/Q
 - VKHB 2280 BT1-0084/Q
 - VKHB 2003 32312 J2/Q
 - VKHB 2002 32311 J2
 - VKHB 2002 32311 J2
- VKS 6150 42)
- VKS 6150 24)
- VKS 6315 42),43)
- VKS 6150
VKS 6146
- VKS 6315 42),44)
- VKS 6150
VKS 6146
- VKS 6150



	<ul style="list-style-type: none"> ● AL 7/52 DS-7.5, AL 7/52 D-9 ○ HL 7/ 50 DCS- 11.5, HL 7/050 DCS-13, HL 7/052 DS-13 ○ HL 7/ 50 DCS- 11.5, HL 7/050 DCS-13, HL 7/052 DS-13 ○ HL 8/1 DCS-13 ○ NS 4/50 DC-10 ○ NS 4/50 DCL-7.5 	<p>VKBA 5369</p> <p>VKBA 5370</p> <p>VKBA 5401</p> <p>VKBA 5375</p>		<ul style="list-style-type: none"> ● VKHB 2082 VKHB 2323 ● VKHB 2162 VKHB 2306 ● VKHB 2163 VKHB 2165 ● VKHB 2163 VKHB 2329 ● VKHB 2124 VKHB 2326 ● VKHB 2280 ● VKHB 2003 	<p>33019/Q 32021 X/ 528595</p> <p>33021/Q 32020 X/Q</p> <p>33022 33220</p> <p>33022 KHM.220110/ 567549</p> <p>33020/Q 33116/Q</p> <p>BT1-0084/Q</p> <p>32312 J2/Q</p>	<p>VKS 6194</p> <p>VKS 6334 29)</p> <p>VKS 6334 30)</p> <p>VKS 6353</p> <p>VKS 6150</p> <p>VKS 6315 VKS 6150 VKS 6146</p>	
ATEGO, 2500 Ser.	<ul style="list-style-type: none"> ● VL 4/51 DC-7.5, VL 4/54 DC-8, VL 4/52 DC-7.5, VL 4/53 DC-7.5 ● VL 4/51 DC-7.5, VL 4/54 DC-8, VL 4/52 DC-7.5, VL 4/53 DC-7.5 ● VL 4/51 DC-7.5, VL 4/54 DC-8, VL 4/52 DC-7.5, VL 4/53 DC-7.5 ● VL 5/21 DC-9 ○ HL 7/50 DCS-11.5 ○ HL 7/50 DCS-11.5 ○ HL 8/1 DCS-13 ○ HL 7/052 DS-13 ○ HL 7/052 DS-13 ○ NS 4/50 DC-10 ○ NS 4/50 DCL-7.5 	<p>VKBA 5039</p> <p>VKBA 5375</p> <p>VKBA 5369</p> <p>VKBA 5370</p> <p>VKBA 5401</p> <p>VKBA 5369</p> <p>VKBA 5370</p> <p>VKBA 5375</p>	<p>VKA 4095</p>	<ul style="list-style-type: none"> ● VKHB 2072 VKHB 2070 ● VKHB 2307 ● VKHB 2003 ● VKHB 2280 ● VKHB 2003 ● VKHB 2002 VKHB 2002 ● VKHB 2162 VKHB 2306 ● VKHB 2163 VKHB 2165 ● VKHB 2163 VKHB 2329 ● VKHB 2162 VKHB 2306 ● VKHB 2163 VKHB 2165 ● VKHB 2124 VKHB 2326 ● VKHB 2280 ● VKHB 2003 	<p>32314 J2/Q 32310 J2/Q</p> <p>801785</p> <p>32312 J2/Q</p> <p>BT1-0084/Q</p> <p>32312 J2/Q</p> <p>32311 J2 32311 J2</p> <p>33021/Q 32020 X/Q</p> <p>33022 33220</p> <p>33022 KHM.220110/ 567549</p> <p>33021/Q 32020 X/Q</p> <p>33022 33220</p> <p>33020/Q 33116/Q</p> <p>BT1-0084/Q</p> <p>32312 J2/Q</p>	<p>VKS 6150 24)</p> <p>VKS 6315 VKS 6150 VKS 6146 42,43)</p> <p>VKS 6315 VKS 6150 VKS 6146 42),44)</p> <p>VKS 6150</p> <p>VKS 6334 29)</p> <p>VKS 6334 30)</p> <p>VKS 6353</p> <p>VKS 6334 29)</p> <p>VKS 6334 30)</p> <p>VKS 6150</p> <p>VKS 6315 VKS 6150 VKS 6146</p>	





MERCEDES-BENZ .../...

ATEGO, 2600 Ser.

●	VL 4/50 DC-7.5, VL 4/51 DC-7.5, VL 4/55 D-7.5, VL 4/56 D-7.5, VL 4/54 DC-8	VKBA 5039	●	VKHB 2072	32314 J2/Q	VKS 6150	24)
			●	VKHB 2070	32310 J2/Q		
●	VL 4/50 DC-7.5, VL 4/51 DC-7.5, VL 4/55 D-7.5, VL 4/56 D-7.5, VL 4/54 DC-8		●	VKHB 2307	801785	VKS 6315	42,43)
			●	VKHB 2003	32312 J2/Q	VKS 6150 VKS 6146	
●	VL 4/50 DC-7.5, VL 4/51 DC-7.5, VL 4/55 D-7.5, VL 4/56 D-7.5, VL 4/54 DC-8	VKBA 5375	●	VKHB 2280	BT1-0084/Q	VKS 6315	42),44)
			●	VKHB 2003	32312 J2/Q	VKS 6150 VKS 6146	
○	HL 7/50 DC-11.5, HL 7/ 50 DCGS-11.5, HL 7/52 DS-11.5	VKBA 5369	●	VKHB 2162	33021/Q	VKS 6334	29)
			●	VKHB 2306	32020 X/Q		
○	HL 7/50 DC-11.5, HL 7/ 50 DCGS-11.5, HL 7/52 DS-11.5	VKBA 5370	●	VKHB 2163	33022	VKS 6334	30)
			●	VKHB 2165	33220		
○	NS 4/50 DC-10		●	VKHB 2124	33020/Q	VKS 6150	
			●	VKHB 2326	33116/Q		
○	NS 4/50 DCL-7.5	VKBA 5375	●	VKHB 2280	BT1-0084/Q	VKS 6315	
			●	VKHB 2003	32312 J2/Q	VKS 6150 VKS 6146	

ACTROS, 1800 Ser. AX-OR, 1835, 1840, 1843

●	VL 5/1 D-9		●	VKHB 2203	JH415647-99401		24)
			●	VKHB 2002	32311 J2		
●	VL 5/1 D-9	VKA 4095	●	VKHB 2002	32311 J2	VKS 6150	42)
			●	VKHB 2002	32311 J2		
●	VL 5/20 DC-9, VL 5/21 DC-9	VKA 4095	●	VKHB 2002	32311 J2	VKS 6150	
			●	VKHB 2002	32311 J2		
●	VL 4/50 DC-7.5, VL 4/51 DC-7.5, VL 4/52 DC-7.5, VL 4/53 DC-7.5, VL 4/27 D-7.5, VL 4/55 D-7.5, VL 4/56 D-7.5, VL 4/54 DC-8	VKBA 5039	●	VKHB 2072	32314 J2/Q	VKS 6150	24)
			●	VKHB 2070	32310 J2/Q		
●	VL 4/50 DC-7.5, VL 4/51 DC-7.5, VL 4/52 DC-7.5, VL 4/53 DC-7.5, VL 4/27 D-7.5, VL 4/55 D-7.5,						



		VL 4/56 D-7.5, VL 4/54 DC-8			<ul style="list-style-type: none"> ● VKHB 2307 801785 ● VKHB 2003 32312 J2/Q 	VKS 6315 VKS 6150 VKS 6146	42,43)
	●	VL 4/50 DC-7.5, VL 4/51 DC-7.5, VL 4/52 DC-7.5, VL 4/53 DC-7.5, VL 4/27 D-7.5, VL 4/55 D-7.5, VL 4/56 D-7.5, VL 4/54 DC-8	VKBA 5375		<ul style="list-style-type: none"> ● VKHB 2280 BT1-0084/Q ● VKHB 2003 32312 J2/Q 	VKS 6315 VKS 6150 VKS 6146	42),44)
	○	HL 7/50 DC-11.5, HL 7/ 50 DCGS-11.5, HL 7/ 50 DCS-11.5, HL 7/050 DCS-13, HL 7/52 DS-11.5, HL 7/ 052 DS-11.5, HL 7/052 DS-13, HL 7/53 DS-16	VKBA 5369		<ul style="list-style-type: none"> ● VKHB 2162 33021/Q ● VKHB 2306 32020 X/Q 	VKS 6334	29)
	○	HL 7/50 DC-11.5, HL 7/ 50 DCGS-11.5, HL 7/ 50 DCS-11.5, HL 7/050 DCS-13, HL 7/52 DS-11.5, HL 7/ 052 DS-11.5, HL 7/052 DS-13, HL 7/53 DS-16	VKBA 5370		<ul style="list-style-type: none"> ● VKHB 2163 33022 ● VKHB 2165 33220 	VKS 6334	30)
	○	NS 4/50 DCL-7.5	VKBA 5375		<ul style="list-style-type: none"> ● VKHB 2280 BT1-0084/Q ● VKHB 2003 32312 J2/Q 	VKS 6315 VKS 6150 VKS 6146	
	○	NS 4/50 DC-10			<ul style="list-style-type: none"> ● VKHB 2124 33020/Q ● VKHB 2326 33116/Q 	VKS 6150	
ACTROS, 1900 Ser.	●	VL 5/1 D-9			<ul style="list-style-type: none"> ● VKHB 2203 JH415647-99401 ● VKHB 2002 32311 J2 		24)
	●	VL 5/1 D-9	VKA 4095		<ul style="list-style-type: none"> ● VKHB 2002 32311 J2 ● VKHB 2002 32311 J2 	VKS 6150	42)
	●	VL 5/20 DC-9, VL 5/21 DC-9	VKA 4095		<ul style="list-style-type: none"> ● VKHB 2002 32311 J2 ● VKHB 2002 32311 J2 	VKS 6150	
	●	VL 4/50 DC-7.5, VL 4/51 DC-7.5, VL 4/52 DC-7.5, VL 4/53 DC-7.5, VL 4/55 D-7.5, VL 4/56 D-7.5, VL 4/54 DC-8	VKBA 5039		<ul style="list-style-type: none"> ● VKHB 2072 32314 J2/Q ● VKHB 2070 32310 J2/Q 	VKS 6150	24)





MERCEDES-BENZ .../...

●	VL 4/50 DC-7.5, VL 4/51 DC-7.5, VL 4/52 DC-7.5, VL 4/53 DC-7.5, VL 4/55 D-7.5, VL 4/56 D-7.5, VL 4/54 DC-8		●	VKHB 2307	801785	VKS 6315 VKS 6150 VKS 6146	42), 43)
●	VL 4/ 50 DC-7.5 VL 4/ 51 DC-7.5, VL 4/ 52 DC-7.5, VL 4/ 53 DC-7.5, VL 4/ 55 DC-7.5, VL 4/ 56 D-7.5, VL 4/ 54 DC-8	VKBA 5375	●	VKHB 2280	BT1-0084/Q	VKS 6315 VKS 6150 VKS 6146	42), 44)
○	HL 7/50 DC-11.5, HL 7/ 50 DCGS-11.5, HL 7/ 50 DCS-11.5, HL 7/50 DCS-13, HL 7/52 DS-11.5, HL 7/052 DS-13, HL 7/053 DS-16	VKBA 5369	●	VKHB 2162 VKHB 2306	33021/Q 32020 X/Q	VKS 6334	29)
○	HL 7/50 DC-11.5, HL 7/ 50 DCGS-11.5, HL 7/ 50 DCS-11.5, HL 7/50 DCS-13, HL 7/52 DS-11.5, HL 7/052 DS-13, HL 7/53 DS-16	VKBA 5370	●	VKHB 2163 VKHB 2165	33022 33220	VKS 6334	30)
○	NS 4/50 DCL-7.5	VKBA 5375	●	VKHB 2280	BT1-0084/Q	VKS 6315 VKS 6150 VKS 6146	
○	NS 4/50 DC-10		●	VKHB 2003	32312 J2/Q	VKS 6150	
			●	VKHB 2124 VKHB 2326	33020/Q 33116/Q	VKS 6150	

ACTROS, 2000 Ser.	●	VL 5/1 D-9		●	VKHB 2203	JH415647- 99401	24)
	●	VL 5/1 D-9	VKA 4095	●	VKHB 2002	32311 J2	VKS 6150 42)
	●	VL 5/20 DC-9, VL 5/21 DC-9	VKA 4095	●	VKHB 2002 VKHB 2002	32311 J2 32311 J2	VKS 6150
	●	VL 4/50 DC-7.5, VL 4/51 DC-7.5, VL 4/52 DC-7.5, VL 4/53 DC-7.5, VL 4/55 D-7.5, VL 4/56 D-7.5, VL 4/54 DC-8	VKBA 5039	●	VKHB 2002 VKHB 2002	32311 J2 32311 J2	VKS 6150
				●	VKHB 2072 VKHB 2070	32314 J2/Q 32310 J2/Q	VKS 6150 24)



	<ul style="list-style-type: none"> VL 4/50 DC-7.5, VL 4/51 DC-7.5, VL 4/52 DC-7.5, VL 4/53 DC-7.5, VL 4/55 D-7.5, VL 4/56 D-7.5, VL 4/54 DC-8 			<ul style="list-style-type: none"> VKHB 2307 801785 		VKS 6315 VKS 6150 VKS 6146	42,43)
	<ul style="list-style-type: none"> VL 4/50 DC-7.5, VL 4/51 DC-7.5, VL 4/52 DC-7.5, VL 4/53 DC-7.5, VL 4/55 D-7.5, VL 4/56 D-7.5, VL 4/54 DC-8 	VKBA 5375		<ul style="list-style-type: none"> VKHB 2280 BT1-0084/Q VKHB 2003 32312 J2/Q 		VKS 6315 VKS 6150 VKS 6146	42),44)
	<ul style="list-style-type: none"> HL 7/50 DC-11.5, HL 7/ 50 DCGS-11.5, HL 7/50 HL 7/ 50 DCS-13, HL 7/ 52 DS-11.5, HL 7/ 052 DS-13, HL 7/ 53 DS-16 	VKBA 5369		<ul style="list-style-type: none"> VKHB 2162 33021/Q VKHB 2306 32020 X/Q 		VKS 6334	29)
	<ul style="list-style-type: none"> HL 7/50 DC-11.5, HL 7/ 50 DCGS-11.5, HL 7/ 50 DCS-11.5, HL 7/50 DCS-13, HL 7/52 DS-11.5, HL 7/052 DS-13, HL 7/53 DS-16 	VKBA 5370		<ul style="list-style-type: none"> VKHB 2163 33022 VKHB 2165 33220 		VKS 6334	30)
	<ul style="list-style-type: none"> NS 4/50 DCL-7.5 	VKBA 5375		<ul style="list-style-type: none"> VKHB 2280 BT1-0084/Q 		VKS 6315 VKS 6150 VKS 6146	
	<ul style="list-style-type: none"> NS 4/50 DC-10 			<ul style="list-style-type: none"> VKHB 2003 32312 J2/Q VKHB 2124 33020/Q VKHB 2326 33116/Q 		VKS 6150	
ACTROS, 2500 Ser.	<ul style="list-style-type: none"> VL 5/1 D-9 			<ul style="list-style-type: none"> VKHB 2203 JH415647-99401 			24)
	<ul style="list-style-type: none"> VL 5/21 DC-9 		VKA 4095	<ul style="list-style-type: none"> VKHB 2002 32311 J2 		VKS 6150	
	<ul style="list-style-type: none"> VL 4/50 DC-7.5, VL 4/51 DC-7.5, VL 4/52 DC-7.5, VL 4/53 DC-7.5, VL 4/55 D-7.5, VL 4/56 D-7.5, VL 4/54 DC-8 	VKBA 5039		<ul style="list-style-type: none"> VKHB 2002 32311 J2 VKHB 2002 32311 J2 			
	<ul style="list-style-type: none"> VL 4/50 DC-7.5, VL 4/51 DC-7.5, VL 4/52 DC-7.5, VL 4/53 DC-7.5, VL 4/55 D-7.5, 			<ul style="list-style-type: none"> VKHB 2072 32314 J2/Q VKHB 2070 32310 J2/Q 		VKS 6150	24)





MERCEDES-BENZ

.../...

VL 4/56 D-7.5,
VL 4/54 DC-8

- VKHB 2307 801785 VKS 6315 42,43)
- VKHB 2003 32312 J2/Q VKS 6150 VKS 6146

- VL 4/50 DC-7.5,
VL 4/51 DC-7.5,
VL 4/52 DC-7.5,
VL 4/53 DC-7.5,
VL 4/55 D-7.5,
VL 4/56 D-7.5,
VL 4/54 DC-8

VKBA 5375

- VKHB 2280 BT1-0084/Q VKS 6315 42),44)
- VKHB 2003 32312 J2/Q VKS 6150 VKS 6146

- HL 7/50 DC-11.5,
VL 7/
50 DCGS-11.5,
HL 7/
50 DCS-11.5,
HL 7/050 DCS-13,
HL 7/52 DS-11.5,
HL 7/052 DS-13

VKBA 5369

- VKHB 2162 33021/Q VKS 6334 29)
- VKHB 2306 32020 X/Q

- HL 7/50 DC-11.5,
HL 7/
50 DCGS-11.5,
HL 7/
50 DCS-11.5,
HL 7/050 DCS-13,
HL 7/52 DS-11.5,
HL 7/052 DS-13

VKBA 5370

- VKHB 2163 33022 VKS 6334 30)
- VKHB 2165 33220

- NS 4/50 DCL-7.5

VKBA 5375

- VKHB 2280 BT1-0084/Q VKS 6315 VKS 6150 VKS 6146
- VKHB 2003 32312 J2/Q

- NS 4/50 DC-10

- VKHB 2124 33020/Q VKS 6150
- VKHB 2326 33116/Q

ACTROS, 2600 Ser.

- VL 5/1 D-9

- VKHB 2203 JH415647-99401 24)
- VKHB 2002 32311 J2

- VL 5/1 D-9

VKA 4095

- VKHB 2002 32311 J2 VKS 6150 42)
- VKHB 2002 32311 J2

- VL 5/20 DC-9,
VL 5/21 DC-9

VKA 4095

- VKHB 2002 32311 J2 VKS 6150
- VKHB 2002 32311 J2

- VL 4/50 DC-7.5,
VL 4/51 DC-7.5,
VL 4/52 DC-7.5,
VL 4/55 D-7.5,
VL 4/56 D-7.5,
VL 4/54 DC-8

VKBA 5039

- VKHB 2072 32314 J2/Q VKS 6150 24)
- VKHB 2070 32310 J2/Q

- VL 4/50 DC-7.5,
VL 4/51 DC-7.5,
VL 4/52 DC-7.5,
VL 4/55 D-7.5,
VL 4/56 D-7.5,
VL 4/54 DC-8

- VKHB 2307 801785 VKS 6315 42,43)
- VKHB 2003 32312 J2/Q VKS 6150 VKS 6146



	<ul style="list-style-type: none"> ● VL 4/50 DC-7.5, VL 4/51 DC-7.5, VL 4/52 DC-7.5, VL 4/55 D-7.5, VL 4/56 D-7.5, VL 4/54 DC-8 	VKBA 5375		<ul style="list-style-type: none"> ● VKHB 2280 	BT1-0084/Q	VKS 6315 VKS 6150 VKS 6146	42),44)
	<ul style="list-style-type: none"> ● VKHB 2003 				32312 J2/Q		
	<ul style="list-style-type: none"> ○ HL 7/50 DC-11.5, HL 7/ 50 DCGS-11.5, HL 7/ 50 DCS-11.5, HL 7/050 DCS-13, HL 7/52 DS-11.5, HL 7/052 DS-13 	VKBA 5369		<ul style="list-style-type: none"> ● VKHB 2162 ● VKHB 2306 	33021/Q 32020 X/Q	VKS 6334	29)
	<ul style="list-style-type: none"> ○ HL 7/50 DC-11.5, HL 7/ 50 DCGS-11.5, HL 7/ 50 DCS-11.5, HL 7/050 DCS-13, HL 7/52 DS-11.5, HL 7/052 DS-13 	VKBA 5370		<ul style="list-style-type: none"> ● VKHB 2163 ● VKHB 2165 	33022 33220	VKS 6334	30)
	<ul style="list-style-type: none"> ○ NS 4/50 DCL-7.5 	VKBA 5375		<ul style="list-style-type: none"> ● VKHB 2280 	BT1-0084/Q	VKS 6315 VKS 6150 VKS 6146	
	<ul style="list-style-type: none"> ○ NS 4/50 DC-10 			<ul style="list-style-type: none"> ● VKHB 2003 ● VKHB 2124 ● VKHB 2326 	32312 J2/Q 33020/Q 33116/Q	VKS 6150	
ACTROS, 3200 Ser.	<ul style="list-style-type: none"> ● VL 4/53 DC-7.5, VL 4/55 D-7.5 	VKBA 5039		<ul style="list-style-type: none"> ● VKHB 2072 ● VKHB 2070 	32314 J2/Q 32310 J2/Q	VKS 6150	24)
	<ul style="list-style-type: none"> ● VL 4/53 DC-7.5, VL 4/55 D-7.5 			<ul style="list-style-type: none"> ● VKHB 2307 	801785	VKS 6315 VKS 6150 VKS 6146	42,43)
	<ul style="list-style-type: none"> ● VL 4/53 DC-7.5, VL 4/55 D-7.5 	VKBA 5375		<ul style="list-style-type: none"> ● VKHB 2003 	32312 J2/Q	VKS 6146	
	<ul style="list-style-type: none"> ● VL 4/53 DC-7.5, VL 4/55 D-7.5 			<ul style="list-style-type: none"> ● VKHB 2280 	BT1-0084/Q	VKS 6315 VKS 6150 VKS 6146	42,44)
	<ul style="list-style-type: none"> ● VL 4/53 DC-7.5, VL 4/55 D-7.5 			<ul style="list-style-type: none"> ● VKHB 2003 	32312 J2/Q	VKS 6146	
	<ul style="list-style-type: none"> ○ HL 7/50 DC-11.5, HL 7/ 50 DCGS-11.5, HL 7/ 50 DCS-11.5, HL 7/52 DS-11.5, HL 7/052 DS-13 	VKBA 5369		<ul style="list-style-type: none"> ● VKHB 2162 ● VKHB 2306 	33021/Q 32020 X/Q	VKS 6334	29)
	<ul style="list-style-type: none"> ○ HL 7/50 DC-11.5, HL 7/ 50 DCGS-11.5, HL 7/ 50 DCS-11.5, HL 7/52 DS-11.5, HL 7/052 DS-13 	VKBA 5370		<ul style="list-style-type: none"> ● VKHB 2163 ● VKHB 2165 	33022 33220	VKS 6334	30)
	<ul style="list-style-type: none"> ○ NS 4/50 DCL-7.5 	VKBA 5375		<ul style="list-style-type: none"> ● VKHB 2280 	BT1-0084/Q	VKS 6315 VKS 6150 VKS 6146	
				<ul style="list-style-type: none"> ● VKHB 2003 	32312 J2/Q	VKS 6146	





MERCEDES-BENZ

.../...

○ NS 4/50 DC-10

● VKHB 2124
● VKHB 2326

33020/Q
33116/Q

VKS 6150

ACTROS, 3300 Ser

● VL 5/1 D-9

● VKHB 2203 JH415647-99401
● VKHB 2002 32311 J2

24)

● VL 5/1 D-9

VKA 4095

● VKHB 2002 32311 J2
● VKHB 2002 32311 J2

VKS 6150

42)

● VL 5/20 DC-9,
VL 5/21 DC-9

VKA 4095

● VKHB 2002 32311 J2
● VKHB 2002 32311 J2

VKS 6150

● VL 4/50 DC-7.5,
VL 4/55 D-7.5,
VL 4/56 D-7.5,
VL 4/54 DC-8

VKBA 5039

● VKHB 2072 32314 J2/Q
● VKHB 2070 32310 J2/Q

VKS 6150

24)

● VL 4/50 DC-7.5,
VL 4/55 D-7.5,
VL 4/56 D-7.5,
VL 4/54 DC-8

● VKHB 2307 801785
● VKHB 2003 32312 J2/Q

VKS 6315
VKS 6150
VKS 6146

42,43)

● VL 4/50 DC-7.5,
VL 4/55 D-7.5,
VL 4/56 D-7.5,
VL 4/54 DC-8

VKBA 5375

● VKHB 2280 BT1-0084/Q
● VKHB 2003 32312 J2/Q

VKS 6315
VKS 6150
VKS 6146

42,44)

○ HL 7/050 DCS-13,
HL 7/50 DCS-16,
HL 7/52 DS-11.5,
HL 7/052 DS-13,
HL 7/53 DS-16

VKBA 5369

● VKHB 2162 33021/Q
● VKHB 2306 32020 X/Q

VKS 6334

29)

○ HL 7/050 DCS-13,
HL 7/50 DCS-16,
HL 7/52 DS-11.5,
HL 7/052 DS-13,
HL 7/53 DS-16

VKBA 5370

● VKHB 2163 33022
● VKHB 2165 33220

VKS 6334

30)

○ NS 4/50 DCL-7.5

VKBA 5375

● VKHB 2280 BT1-0084/Q
● VKHB 2003 32312 J2/Q

VKS 6315
VKS 6150
VKS 6146

○ NS 4/50 DC-10

● VKHB 2124 33020/Q
● VKHB 2326 33116/Q

VKS 6150

ACTROS, 4100 Ser.

● VL 5/1 D-9

● VKHB 2203 JH415647-99401
● VKHB 2002 32311 J2

24)

● VL 5/1 D-9

VKA 4095

● VKHB 2002 32311 J2
● VKHB 2002 32311 J2

VKS 6150

42)

● VL 4/53 DC-7.5,
VL 4/27 D-7.5,
VL 4/55 D-7.5

VKBA 5039

● VKHB 2072 32314 J2/Q
● VKHB 2070 32310 J2/Q

VKS 6150

24)



●	VL 4/53 DC-7.5, VL 4/27 D-7.5, VL 4/55 D-7.5		●	VKHB 2307	801785	VKS 6315 VKS 6150 VKS 6146	42,43)
●	VL 4/53 DC-7.5, VL 4/27 D-7.5, VL 4/55 D-7.5	VKBA 5375	●	VKHB 2003	32312 J2/Q		
○	HL 7/050 DCS-13, HL 7/052 DS-13, HL 7/53 DS-16	VKBA 5369	●	VKHB 2280	BT1-0084/Q	VKS 6315 VKS 6150 VKS 6146	42,44)
○	HL 7/050 DCS-13, HL 7/052 DS-13, HL 7/53 DS-16	VKBA 5370	●	VKHB 2003	32312 J2/Q		
○	NS 4/50 DCL-7.5	VKBA 5375	●	VKHB 2162	33021/Q	VKS 6334	29)
○	NS 4/50 DC-10		●	VKHB 2306	32020 X/Q		
			●	VKHB 2163	33022	VKS 6334	30)
			●	VKHB 2165	33220		
			●	VKHB 2280	BT1-0084/Q	VKS 6315 VKS 6150 VKS 6146	
			●	VKHB 2003	32312 J2/Q		
			●	VKHB 2124	33020/Q	VKS 6150	
			●	VKHB 2326	33116/Q		











MERCEDES-BENZ "Baumuster"

730.001-.002, 730.004			●	VKHB 2064	529656	VKS 6157	
730.005			●	VKHB 2066	33214/Q	VKS 6175	
730.006-.010			●	VKHB 2068	33210/Q		
730.011-.012			●	VKHB 2051	33213/Q	VKS 6157	
			●	VKHB 2065	33208/Q		
730.016-.019			●	VKHB 2066	33214/Q	VKS 6175	11)
			●	VKHB 2068	33210/Q		
			●	VKHB 2066	33214/Q	VKS 6175	10)
			●	VKHB 2067	33209/Q		
730.020			●	VKHB 2051	33213/Q	VKS 6157	
			●	VKHB 2065	33208/Q		
730.021			●	VKHB 2066	33214/Q	VKS 6175	
			●	VKHB 2068	33210/Q		
730.022			●	VKHB 2051	33213/Q	VKS 6157	
			●	VKHB 2065	33208/Q		



MERCEDES-BENZ "Baumuster" .../...

730.030-.031				•	VKHB 2064	529656	VKS 6157	
730.034				•	VKHB 2066	33214/Q	VKS 6175	10)
				•	VKHB 2067	33209/Q		
				•	VKHB 2066	33214/Q	VKS 6175	11)
				•	VKHB 2068	33210/Q		
730.036, 730.039				•	VKHB 2064	529656	VKS 6157	
730.041, 730.043				•	VKHB 2066	33214/Q	VKS 6175	
				•	VKHB 2068	33210/Q		
730.044				•	VKHB 2051	33213/Q	VKS 6157	
				•	VKHB 2065	33208/Q		
730.045				•	VKHB 2066	33214/Q	VKS 6175	
				•	VKHB 2068	33210/Q		
730.048				•	VKHB 2051	33213/Q	VKS 6157	
				•	VKHB 2065	33208/Q		
730.050				•	VKHB 2066	33214/Q	VKS 6175	
				•	VKHB 2068	33210/Q		
730.052, 730.056-.060, 730.062-.066				•	VKHB 2051	33213/Q	VKS 6157	
				•	VKHB 2065	33208/Q		
730.100-.101				•	VKHB 2082	33019/Q	VKS 6194	
				•	VKHB 2323	32021 X/ 528595		
730.200, 730.230-.231				•	VKHB 2066	33214/Q	VKS 6175	
				•	VKHB 2067	33209/Q		
730.403-.404		VKBA 596		•				
				•				
730.405, 730.407-.414		VKBA 3434		•				
				•				
730.445-.446		VKBA 596		•				
				•				
730.447-.448		VKBA 3434		•				
				•				









									
730.502			VKBA 5025		<ul style="list-style-type: none"> ● VKHB 2058 ● VKHB 2018 ● VKHB 2054 ● VKHB 2055 ● VKHB 2056 ● VKHB 2057 	32304 J2/Q 32207 J2/Q 2789/2720/ QCL7C 1380/1328/Q 33109/Q 33205/QVQ077	VKS 6299	6) 7) 8)	
730.503-.504			VKBA 5025		<ul style="list-style-type: none"> ● VKHB 2054 ● VKHB 2055 ● VKHB 2056 ● VKHB 2057 	2789/2720/ QCL7C 1380/1328/Q 33109/Q 33205/QVQ077	VKS 6299	4) 5)	
730.505			VKBA 5025		<ul style="list-style-type: none"> ● VKHB 2056 ● VKHB 2057 	33109/Q 33205/QVQ077	VKS 6299		
730.506			VKBA 5025		<ul style="list-style-type: none"> ● VKHB 2054 ● VKHB 2055 ● VKHB 2056 ● VKHB 2057 	2789/2720/ QCL7C 1380/1328/Q 33109/Q 33205/QVQ077	VKS 6299	4) 5)	
730.531			VKBA 5025		<ul style="list-style-type: none"> ● VKHB 2054 ● VKHB 2055 ● VKHB 2056 ● VKHB 2057 	2789/2720/ QCL7C 1380/1328/Q 33109/Q 33205/QVQ077	VKS 6299	4) 5)	
730.532			VKBA 5025		<ul style="list-style-type: none"> ● VKHB 2058 ● VKHB 2018 ● VKHB 2054 ● VKHB 2055 ● VKHB 2056 ● VKHB 2057 	32304 J2/Q 32207 J2/Q 2789/2720/ QCL7C 1380/1328/Q 33109/Q 33205/QVQ077	VKS 6299	6) 7) 8)	
730.533			VKBA 5025		<ul style="list-style-type: none"> ● VKHB 2056 ● VKHB 2057 	33109/Q 33205/QVQ077	VKS 6299		
730.534-.535			VKBA 5025		<ul style="list-style-type: none"> ● VKHB 2054 ● VKHB 2055 ● VKHB 2056 ● VKHB 2057 	2789/2720/ QCL7C 1380/1328/Q 33109/Q 33205/QVQ077	VKS 6299	4) 5)	
730.600-.603, 730.630			VKBA 5025		<ul style="list-style-type: none"> ● VKHB 2056 ● VKHB 2057 	33109/Q 33205/QVQ077	VKS 6299		
730.702					<ul style="list-style-type: none"> ● VKHB 2060 ● VKHB 2016 	32011 X/Q 32206 J2/Q	VKS 6159		





MERCEDES-BENZ "Baumuster" .../...

730.703-.704		VKBA 5026	● ●	VKHB 2059 VKHB 2007	33111/Q 32306 J2/Q	VKS 6159
730.705		VKBA 5028	● ●	VKHB 2061 VKHB 2007	33211/Q 32306 J2/Q	VKS 6148
730.706		VKBA 5026	● ●	VKHB 2059 VKHB 2007	33111/Q 32306 J2/Q	VKS 6159
730.708-.709		VKBA 5028	● ●	VKHB 2061 VKHB 2007	33211/Q 32306 J2/Q	VKS 6148
730.713-.714			● ●	VKHB 2318 VKHB 2317	33111 JR 32306 JR	
730.023-.024			● ●	VKHB 2319 VKHB 2320	33213 JR 33208 JR-1/ 33208 J	
730.730		VKBA 5026	● ●	VKHB 2059 VKHB 2007	33111/Q 32306 J2/Q	VKS 6159
730.731			● ●	VKHB 2061 VKHB 2064	33211/Q 529656	VKS 6148
730.732		VKBA 5026	● ●	VKHB 2059 VKHB 2007	33111/Q 32306 J2/Q	VKS 6159
730.733		VKBA 5028	● ●	VKHB 2061 VKHB 2007	33211/Q 32306 J2/Q	VKS 6148
730.736			● ●	VKHB 2061 VKHB 2064	33211/Q 529656	VKS 6148
730.800		VKBA 5026	● ●	VKHB 2059 VKHB 2007	33111/Q 32306 J2/Q	VKS 6159
730.801		VKBA 5028	● ●	VKHB 2061 VKHB 2007	33211/Q 32306 J2/Q	VKS 6148
730.802, 730.830-.832			● ●	VKHB 2061 VKHB 2064	33211/Q 529656	VKS 6148
731.000, 731.002, 731.004-.009, 731.012, 731.031-.033, 731.035-.037, 731.044-.045, 731.048-.057			●	VKHB 2172	331974 A/Q	

								
					●	VKHB 2161	32019 X/Q	VKS 6194
731.700					●	VKHB 2321	33017/Q	
731.720					●	VKHB 2124 VKHB 2169	33020/Q 32017 X/Q	
739.001-.003					●	VKHB 2070	32310 J2/Q	
739.006			VKBA 5039		●	VKHB 2072 VKHB 2070	32314 J2/Q 32310 J2/Q	VKS 6150
739.007, 739.016-.019, 739.030-.031			VKBA 5038	VKA 4094	●	VKHB 2071 VKHB 2070	332330 B/Q 32310 J2/Q	VKS 6158 VKS 6146
739.032			VKBA 5039		●	VKHB 2072 VKHB 2070	32314 J2/Q 32310 J2/Q	VKS 6150
739.033			VKBA 5038	VKA 4094	●	VKHB 2071 VKHB 2070	332330 B/Q 32310 J2/Q	VKS 6158 VKS 6146
739.034, 739.036			VKBA 5039		●	VKHB 2072 VKHB 2070	32314 J2/Q 32310 J2/Q	VKS 6150
739.037-.039					●	VKHB 2071 VKHB 2068	332330 B/Q 33210/Q	VKS 6158 VKS 6146
739.040-.047			VKBA 5039		●	VKHB 2072 VKHB 2070	32314 J2/Q 32310 J2/Q	VKS 6150
739.048-.049			VKBA 5038	VKA 4094	●	VKHB 2071 VKHB 2070	332330 B/Q 32310 J2/Q	VKS 6158 VKS 6146
739.050, 739.052-.053			VKBA 5039		●	VKHB 2072 VKHB 2070	32314 J2/Q 32310 J2/Q	VKS 6150
739.054-.055			VKBA 5038	VKA 4094	●	VKHB 2071 VKHB 2070	332330 B/Q 32310 J2/Q	VKS 6158 VKS 6146
739.056-.061, 739.064, 739.066, 739.070			VKBA 5039		●	VKHB 2072 VKHB 2070	32314 J2/Q 32310 J2/Q	VKS 6150
739.071-.072			VKBA 5038	VKA 4094	●	VKHB 2071 VKHB 2070	332330 B/Q 32310 J2/Q	VKS 6158 VKS 6146





MERCEDES-BENZ "Baumuster" .../...

739.073-.074,
739.076-.081

VKBA 5039

● ●

VKHB 2072
VKHB 2070

32314 J2/Q
32310 J2/Q

VKS 6150

739.082

VKBA 5038

VKA 4094

● ●

VKHB 2071
VKHB 2070

332330 B/Q
32310 J2/Q

VKS 6158
VKS 6146

739.083

VKBA 5039

● ●

VKHB 2072
VKHB 2070

32314 J2/Q
32310 J2/Q

VKS 6150

739.084

VKBA 5038

VKA 4094

● ●

VKHB 2071
VKHB 2070

332330 B/Q
32310 J2/Q

VKS 6158
VKS 6146

739.086

VKBA 5039

● ●

VKHB 2072
VKHB 2070

32314 J2/Q
32310 J2/Q

VKS 6150

739.087-.088

VKBA 5038

VKA 4094

● ●

VKHB 2071
VKHB 2070

332330 B/Q
32310 J2/Q

VKS 6158
VKS 6146

739.089-.092

VKBA 5039

● ●

VKHB 2072
VKHB 2070

32314 J2/Q
32310 J2/Q

VKS 6150

739.093

VKBA 5038

VKA 4094

● ●

VKHB 2071
VKHB 2070

332330 B/Q
32310 J2/Q

VKS 6158
VKS 6146

739.094

VKBA 5039

● ●

VKHB 2072
VKHB 2070

32314 J2/Q
32310 J2/Q

VKS 6150

739.096-.099

VKBA 5038

VKA 4094

● ●

VKHB 2071
VKHB 2070

332330 B/Q
32310 J2/Q

VKS 6158
VKS 6146

739.100

VKBA 5039

● ●

VKHB 2071
VKHB 2068

332330 B/Q
33210/Q

VKS 6158
VKS 6146

739.102, 739.104

VKBA 5038

VKA 4094

● ●

VKHB 2071
VKHB 2070

332330 B/Q
32310 J2/Q

VKS 6158
VKS 6146

739.105-.106, 739.109

VKBA 5039

● ●

VKHB 2071
VKHB 2068

332330 B/Q
33210/Q

VKS 6158
VKS 6146

739.110-.111

VKBA 5038

VKA 4094

● ●

VKHB 2071
VKHB 2070

332330 B/Q
32310 J2/Q

VKS 6158
VKS 6146

739.112

VKBA 5038

VKA 4094

● ●
● ●











VKHB 2071
VKHB 2070
VKHB 2071
VKHB 2068

332330 B/Q
32310 J2/Q
332330 B/Q
33210/Q

VKS 6158
VKS 6146
VKS 6158
VKS 6146

14)

13)











										
739.113				VKBA 5038	VKA 4094	● ●	VKHB 2071 VKHB 2070	332330 B/Q 32310 J2/Q	VKS 6158 VKS 6146	
739.114				VKBA 5039		● ●	VKHB 2072 VKHB 2070	32314 J2/Q 32310 J2/Q	VKS 6150	
739.115				VKBA 5038	VKA 4094	● ● ● ●	VKHB 2071 VKHB 2070 VKHB 2071 VKHB 2068	332330 B/Q 32310 J2/Q 332330 B/Q 33210/Q	VKS 6158 VKS 6146 VKS 6158 VKS 6146	
739.116-.117				VKBA 5039		● ●	VKHB 2072 VKHB 2070	32314 J2/Q 32310 J2/Q	VKS 6150	
739.118-.120				VKBA 5038	VKA 4094	● ●	VKHB 2071 VKHB 2070	332330 B/Q 32310 J2/Q	VKS 6158 VKS 6146	
739.121-.123				VKBA 5039		● ●	VKHB 2072 VKHB 2070	32314 J2/Q 32310 J2/Q	VKS 6150	
739.130-.131				VKBA 5038	VKA 4094	● ● ●	VKHB 2071 VKHB 2068 VKHB 2071 VKHB 2070	332330 B/Q 33210/Q 332330 B/Q 32310 J2/Q	VKS 6158 VKS 6146 VKS 6158 VKS 6146	13) 14)
739.133-.134				VKBA 5039		● ●	VKHB 2072 VKHB 2070	32314 J2/Q 32310 J2/Q	VKS 6150	
739.136				VKBA 5038	VKA 4094	● ● ●	VKHB 2071 VKHB 2068 VKHB 2071 VKHB 2070	332330 B/Q 33210/Q 332330 B/Q 32310 J2/Q	VKS 6158 VKS 6146 VKS 6158 VKS 6146	13) 14)
739.137						● ●	VKHB 2071 VKHB 2068	332330 B/Q 33210/Q	VKS 6158 VKS 6146	
739.138				VKBA 5038	VKA 4094	● ●	VKHB 2071 VKHB 2070	332330 B/Q 32310 J2/Q	VKS 6158 VKS 6146	
739.139				VKBA 5038	VKA 4094	● ● ●	VKHB 2071 VKHB 2068 VKHB 2071 VKHB 2070	332330 B/Q 33210/Q 332330 B/Q 32310 J2/Q	VKS 6158 VKS 6146 VKS 6158 VKS 6146	28) 27)
739.140						● ●	VKHB 2071 VKHB 2068	332330 B/Q 33210/Q	VKS 6158 VKS 6146	
739.140-.145				VKBA 5038	VKA 4094	● ●	VKHB 2071 VKHB 2070	332330 B/Q 32310 J2/Q	VKS 6158 VKS 6146	





MERCEDES-BENZ "Baumuster" .../...

739.146-.149		VKBA 5039		●	VKHB 2072 VKHB 2070	32314 J2/Q 32310 J2/Q	VKS 6150
739.150-.157		VKBA 5038	VKA 4094	●	VKHB 2071 VKHB 2070	332330 B/Q 32310 J2/Q	VKS 6158 VKS 6146
739.158-.159		VKBA 5039		●	VKHB 2072 VKHB 2070	32314 J2/Q 32310 J2/Q	VKS 6150
739.160		VKBA 5038	VKA 4094	●	VKHB 2071 VKHB 2070	332330 B/Q 32310 J2/Q	VKS 6158 VKS 6146
739.161		VKBA 5039		●	VKHB 2072 VKHB 2070	32314 J2/Q 32310 J2/Q	VKS 6150
739.162		VKBA 5038	VKA 4094	●	VKHB 2071 VKHB 2070	332330 B/Q 32310 J2/Q	VKS 6158 VKS 6146
739.163-.165		VKBA 5039		●	VKHB 2072 VKHB 2070	32314 J2/Q 32310 J2/Q	VKS 6150
739.166-.173		VKBA 5038	VKA 4094	●	VKHB 2071 VKHB 2070	332330 B/Q 32310 J2/Q	VKS 6158 VKS 6146
739.174-.175		VKBA 5039		●	VKHB 2072 VKHB 2070	32314 J2/Q 32310 J2/Q	VKS 6150
739.177-.178		VKBA 5038	VKA 4094	●	VKHB 2071 VKHB 2070	332330 B/Q 32310 J2/Q	VKS 6158 VKS 6146
739.179-.181		VKBA 5039		●	VKHB 2072 VKHB 2070	32314 J2/Q 32310 J2/Q	VKS 6150
739.182-.184		VKBA 5038	VKA 4094	●	VKHB 2071 VKHB 2070	332330 B/Q 32310 J2/Q	VKS 6158 VKS 6146
739.187-.188, 739.190		VKBA 5039		●	VKHB 2072 VKHB 2070	32314 J2/Q 32310 J2/Q	VKS 6150
739.191-.195		VKBA 5038	VKA 4094	●	VKHB 2071 VKHB 2070	332330 B/Q 32310 J2/Q	VKS 6158 VKS 6146
739.197-.198		VKBA 5039		●	VKHB 2072 VKHB 2070	32314 J2/Q 32310 J2/Q	VKS 6150

									
739.199, 739.207, 739.209			VKBA 5038	VKA 4094	●	VKHB 2071 VKHB 2070	332330 B/Q 32310 J2/Q	VKS 6158 VKS 6146	
739.400-401					●	VKHB 2203 VKHB 2002	JH415647- 99401 32311 J2		
739.410-411				VKA 4095	●	VKHB 2203 VKHB 2002 VKHB 2002 VKHB 2002	JH415647- 99401 32311 J2 32311 J2 32311 J2	VKS 6150	24) 42)
739.430-431, 739.434					●	VKHB 2203 VKHB 2002	JH415647- 99401 32311 J2		
739.500, 739.510, 739.520, 739.530-531, 739.540-543, 739.550			VKBA 5039 VKBA 5375		●	VKHB 2072 VKHB 2070 VKHB 2307 VKHB 2003 VKHB 2280 VKHB 2003	32314 J2/Q 32310 J2/Q 801785 32312 J2/Q BT1-0084/Q 32312 J2/Q	VKS 6150 VKS 6315 VKS 6150 VKS 6146 VKS 6315 VKS 6150 VKS 6146	24) 42,43) 42),44)
739.560, 739.570				VKA 4095	●	VKHB 2002 VKHB 2002	32311 J2 32311 J2	VKS 6150	
740.000					●	VKHB 2162 VKHB 2161 VKHB 2146 VKHB 2161	33021/Q 32019 X/Q 33021/QVB091 32019 X/Q	VKS 6183 VKS 6181 VKS 6334	25) 26)
740.001					●	VKHB 2160 VKHB 2161	32021 X/Q 32019 X/Q	VKS 6183 VKS 6181	
740.002					●	VKHB 2163 VKHB 2164 VKHB 2163 VKHB 2164	33022 30220 J2 33022 30220 J2	VKS 6183 VKS 6181 VKS 6334	25) 26)
740.003					●	VKHB 2162 VKHB 2161 VKHB 2146 VKHB 2161	33021/Q 32019 X/Q 33021/QVB091 32019 X/Q	VKS 6183 VKS 6181 VKS 6334	25) 26)





MERCEDES-BENZ "Baumuster" .../...

740.004

-
-

VKHB 2160
VKHB 2161

32021 X/Q
32019 X/Q

VKS 6183
VKS 6181

740.005

-
-
-
-

VKHB 2163
VKHB 2164
VKHB 2163
VKHB 2164

33022
30220 J2
33022
30220 J2

VKS 6183
VKS 6181
VKS 6334

25)
26)

740.006-.007

-
-
-
-

VKHB 2162
VKHB 2161
VKHB 2146
VKHB 2161

33021/Q
32019 X/Q
33021/QVB091
32019 X/Q

VKS 6183
VKS 6181
VKS 6334

25)
26)

740.008

-
-
-
-

VKHB 2163
VKHB 2164
VKHB 2163
VKHB 2164

33022
30220 J2
33022
30220 J2

VKS 6183
VKS 6181
VKS 6334

25)
26)

740.009

-
-
-
-

VKHB 2162
VKHB 2161
VKHB 2146
VKHB 2161

33021/Q
32019 X/Q
33021/QVB091
32019 X/Q

VKS 6183
VKS 6181
VKS 6334

25)
26)

740.030

-
-
-
-

VKHB 2162
VKHB 2161
VKHB 2146
VKHB 2161

33021/Q
32019 X/Q
33021/QVB091
32019 X/Q

VKS 6183
VKS 6181
VKS 6334

25)
26)

740.031

-
-
-
-

VKHB 2163
VKHB 2164
VKHB 2163
VKHB 2164

33022
30220 J2
33022
30220 J2

VKS 6183
VKS 6181
VKS 6334

25)
26)

740.033-.034

-
-
-
-

VKHB 2162
VKHB 2161
VKHB 2146
VKHB 2161

33021/Q
32019 X/Q
33021/QVB091
32019 X/Q

VKS 6183
VKS 6181
VKS 6334

25)
26)

740.035-.037

-
-
-
-

VKHB 2163
VKHB 2164
VKHB 2163
VKHB 2164

33022
30220 J2
33022
30220 J2

VKS 6183
VKS 6181
VKS 6334

25)
26)

740.039-.043











-
-
-
-

VKHB 2163
VKHB 2164
VKHB 2163
VKHB 2164

33022
30220 J2
33022
30220 J2

VKS 6183
VKS 6181
VKS 6334

25)
26)

										
740.045						<ul style="list-style-type: none"> ● VKHB 2162 ● VKHB 2161 ● VKHB 2146 ● VKHB 2161 	33021/Q 32019 X/Q 33021/QVB091 32019 X/Q	VKS 6183 VKS 6181 VKS 6334	25) 26)	
740.047-.051						<ul style="list-style-type: none"> ● VKHB 2162 ● VKHB 2161 ● VKHB 2146 ● VKHB 2161 	33021/Q 32019 X/Q 33021/QVB091 32019 X/Q	VKS 6183 VKS 6181 VKS 6334	25) 26)	
740.053						<ul style="list-style-type: none"> ● VKHB 2163 ● VKHB 2164 ● VKHB 2163 ● VKHB 2164 	33022 30220 J2 33022 30220 J2	VKS 6183 VKS 6181 VKS 6334	25) 26)	
740.054-.056						<ul style="list-style-type: none"> ● VKHB 2162 ● VKHB 2161 ● VKHB 2146 ● VKHB 2161 	33021/Q 32019 X/Q 33021/QVB091 32019 X/Q	VKS 6183 VKS 6181 VKS 6334	25) 26)	
740.057-.058						<ul style="list-style-type: none"> ● VKHB 2163 ● VKHB 2164 ● VKHB 2163 ● VKHB 2164 	33022 30220 J2 33022 30220 J2	VKS 6183 VKS 6181 VKS 6334	25) 26)	
740.059-.064						<ul style="list-style-type: none"> ● VKHB 2162 ● VKHB 2161 ● VKHB 2146 ● VKHB 2161 	33021/Q 32019 X/Q 33021/QVB091 32019 X/Q	VKS 6183 VKS 6181 VKS 6334	25) 26)	
740.065-.071						<ul style="list-style-type: none"> ● VKHB 2163 ● VKHB 2164 ● VKHB 2163 ● VKHB 2164 	33022 30220 J2 33022 30220 J2	VKS 6183 VKS 6181 VKS 6334	25) 26)	
740.072						<ul style="list-style-type: none"> ● VKHB 2162 ● VKHB 2161 ● VKHB 2146 ● VKHB 2161 	33021/Q 32019 X/Q 33021/QVB091 32019 X/Q	VKS 6183 VKS 6181 VKS 6334	25) 26)	
740.074						<ul style="list-style-type: none"> ● VKHB 2162 ● VKHB 2161 ● VKHB 2146 ● VKHB 2161 	33021/Q 32019 X/Q 33021/QVB091 32019 X/Q	VKS 6183 VKS 6181 VKS 6334	25) 26)	
740.100-.104						<ul style="list-style-type: none"> ● VKHB 2162 ● VKHB 2161 ● VKHB 2146 ● VKHB 2161 	33021/Q 32019 X/Q 33021/QVB091 32019 X/Q	VKS 6183 VKS 6181 VKS 6334	25) 26)	





MERCEDES-BENZ "Baumuster" .../...

740.105

-

VKHB 2160
VKHB 2161

32021 X/Q
32019 X/Q

VKS 6183
VKS 6181

740.106

-
-
-
-

VKHB 2162
VKHB 2161
VKHB 2146
VKHB 2161

33021/Q
32019 X/Q
33021/QVB091
32019 X/Q

VKS 6183
VKS 6181
VKS 6334

25)
26)

740.107

-
-
-
-

VKHB 2163
VKHB 2164
VKHB 2163
VKHB 2164

33022
30220 J2
33022
30220 J2

VKS 6183
VKS 6181
VKS 6334

25)
26)

740.109

-
-
-
-

VKHB 2163
VKHB 2164
VKHB 2163
VKHB 2164

33022
30220 J2
33022
30220 J2

VKS 6183
VKS 6181
VKS 6334

25)
26)

740.110-.113

-
-
-
-

VKHB 2162
VKHB 2161
VKHB 2146
VKHB 2161

33021/Q
32019 X/Q
33021/QVB091
32019 X/Q

VKS 6183
VKS 6181
VKS 6334

25)
26)

740.114

-
-
-
-

VKHB 2163
VKHB 2164
VKHB 2163
VKHB 2164

33022
30220 J2
33022
30220 J2

VKS 6183
VKS 6181
VKS 6334

25)
26)

740.115-.117

-
-
-
-

VKHB 2162
VKHB 2161
VKHB 2146
VKHB 2161

33021/Q
32019 X/Q
33021/QVB091
32019 X/Q

VKS 6183
VKS 6181
VKS 6334

25)
26)

740.119

-
-
-
-

VKHB 2162
VKHB 2161
VKHB 2146
VKHB 2161

33021/Q
32019 X/Q
33021/QVB091
32019 X/Q

VKS 6183
VKS 6181
VKS 6334

25)
26)

740.130-.133

-
-
-
-

VKHB 2162
VKHB 2161
VKHB 2146
VKHB 2161

33021/Q
32019 X/Q
33021/QVB091
32019 X/Q

VKS 6183
VKS 6181
VKS 6334

25)
26)

740.134-.135











-
-
-
-

VKHB 2163
VKHB 2164
VKHB 2163
VKHB 2164

33022
30220 J2
33022
30220 J2

VKS 6183
VKS 6181
VKS 6334

25)
26)

									
740.136						<ul style="list-style-type: none"> ● VKHB 2162 ● VKHB 2161 ● VKHB 2146 ● VKHB 2161 	33021/Q 32019 X/Q 33021/QVB091 32019 X/Q	VKS 6183 VKS 6181 VKS 6334	25) 26)
740.138-.139						<ul style="list-style-type: none"> ● VKHB 2163 ● VKHB 2164 ● VKHB 2163 ● VKHB 2164 	33022 30220 J2 33022 30220 J2	VKS 6183 VKS 6181 VKS 6334	25) 26)
740.140-.147						<ul style="list-style-type: none"> ● VKHB 2162 ● VKHB 2161 ● VKHB 2146 ● VKHB 2161 	33021/Q 32019 X/Q 33021/QVB091 32019 X/Q	VKS 6183 VKS 6181 VKS 6334	25) 26)
740.148						<ul style="list-style-type: none"> ● VKHB 2163 ● VKHB 2164 ● VKHB 2163 ● VKHB 2164 	33022 30220 J2 33022 30220 J2	VKS 6183 VKS 6181 VKS 6334	25) 26)
740.149-.155						<ul style="list-style-type: none"> ● VKHB 2162 ● VKHB 2161 ● VKHB 2146 ● VKHB 2161 	33021/Q 32019 X/Q 33021/QVB091 32019 X/Q	VKS 6183 VKS 6181 VKS 6334	25) 26)
740.157						<ul style="list-style-type: none"> ● VKHB 2162 ● VKHB 2161 ● VKHB 2146 ● VKHB 2161 	33021/Q 32019 X/Q 33021/QVB091 32019 X/Q	VKS 6183 VKS 6181 VKS 6334	25) 26)
740.159-.172						<ul style="list-style-type: none"> ● VKHB 2162 ● VKHB 2161 ● VKHB 2146 ● VKHB 2161 	33021/Q 32019 X/Q 33021/QVB091 32019 X/Q	VKS 6183 VKS 6181 VKS 6334	25) 26)
740.174-.175						<ul style="list-style-type: none"> ● VKHB 2162 ● VKHB 2161 ● VKHB 2146 ● VKHB 2161 	33021/Q 32019 X/Q 33021/QVB091 32019 X/Q	VKS 6183 VKS 6181 VKS 6334	25) 26)
740.176-.179						<ul style="list-style-type: none"> ● VKHB 2163 ● VKHB 2164 ● VKHB 2163 ● VKHB 2164 	33022 30220 J2 33022 30220 J2	VKS 6183 VKS 6181 VKS 6334	25) 26)
740.180						<ul style="list-style-type: none"> ● VKHB 2162 ● VKHB 2161 ● VKHB 2146 ● VKHB 2161 	33021/Q 32019 X/Q 33021/QVB091 32019 X/Q	VKS 6183 VKS 6181 VKS 6334	25) 26)





MERCEDES-BENZ "Baumuster" .../...

740.181-.184

- VKHB 2163 33022 VKS 6183 25)
- VKHB 2164 30220 J2 VKS 6181
- VKHB 2163 33022 VKS 6334 26)
- VKHB 2164 30220 J2

740.185-.192

- VKHB 2162 33021/Q VKS 6183 25)
- VKHB 2161 32019 X/Q VKS 6181
- VKHB 2146 33021/QVB091 VKS 6334 26)
- VKHB 2161 32019 X/Q

740.195-.198

- VKHB 2162 33021/Q VKS 6183 25)
- VKHB 2161 32019 X/Q VKS 6181
- VKHB 2146 33021/QVB091 VKS 6334 26)
- VKHB 2161 32019 X/Q

740.301-.302

- VKHB 2162 33021/Q VKS 6183 25)
- VKHB 2161 32019 X/Q VKS 6181
- VKHB 2146 33021/QVB091 VKS 6334 26)
- VKHB 2161 32019 X/Q

740.304

- VKHB 2162 33021/Q VKS 6183 25)
- VKHB 2161 32019 X/Q VKS 6181
- VKHB 2146 33021/QVB091 VKS 6334 26)
- VKHB 2161 32019 X/Q

740.305

- VKHB 2163 33022 VKS 6183
- VKHB 2165 33220 VKS 6181

740.306-.307

- VKHB 2163 33022 VKS 6183 25)
- VKHB 2164 30220 J2 VKS 6181
- VKHB 2163 33022 VKS 6334 26)
- VKHB 2164 30220 J2

740.308











- VKHB 2162 33021/Q VKS 6183 25)
- VKHB 2161 32019 X/Q VKS 6181
- VKHB 2146 33021/QVB091 VKS 6334 26)
- VKHB 2161 32019 X/Q

740.309-.310

- VKHB 2163 33022 VKS 6183 25)
- VKHB 2164 30220 J2 VKS 6181
- VKHB 2163 33022 VKS 6334 26)
- VKHB 2164 30220 J2

740.311-.312

- VKHB 2162 33021/Q VKS 6183 25)
- VKHB 2161 32019 X/Q VKS 6181
- VKHB 2146 33021/QVB091 VKS 6334 26)
- VKHB 2161 32019 X/Q











										
740.313						<ul style="list-style-type: none"> ● VKHB 2163 ● VKHB 2164 ● VKHB 2163 ● VKHB 2164 	33022 30220 J2 33022 30220 J2	VKS 6183 VKS 6181 VKS 6334	25) 26)	
740.314						<ul style="list-style-type: none"> ● VKHB 2162 ● VKHB 2161 ● VKHB 2146 ● VKHB 2161 	33021/Q 32019 X/Q 33021/QVB091 32019 X/Q	VKS 6183 VKS 6181 VKS 6334	25) 26)	
740.318-319						<ul style="list-style-type: none"> ● VKHB 2162 ● VKHB 2161 ● VKHB 2146 ● VKHB 2161 	33021/Q 32019 X/Q 33021/QVB091 32019 X/Q	VKS 6183 VKS 6181 VKS 6334	25) 26)	
740.330-333						<ul style="list-style-type: none"> ● VKHB 2162 ● VKHB 2161 ● VKHB 2146 ● VKHB 2161 	33021/Q 32019 X/Q 33021/QVB091 32019 X/Q	VKS 6183 VKS 6181 VKS 6334	25) 26)	
740.334						<ul style="list-style-type: none"> ● VKHB 2163 ● VKHB 2164 	33022 30220 J2	VKS 6183 VKS 6181	25)	
740.334-335						<ul style="list-style-type: none"> ● VKHB 2163 ● VKHB 2164 	33022 30220 J2	VKS 6334	26)	
740.335						<ul style="list-style-type: none"> ● VKHB 2162 ● VKHB 2161 ● VKHB 2146 ● VKHB 2161 	33021/Q 32019 X/Q 33021/QVB091 32019 X/Q	VKS 6183 VKS 6181 VKS 6334	25) 26)	
740.335-336						<ul style="list-style-type: none"> ● VKHB 2163 ● VKHB 2164 	33022 30220 J2	VKS 6183 VKS 6181	25)	
740.336						<ul style="list-style-type: none"> ● VKHB 2163 ● VKHB 2164 	33022 30220 J2	VKS 6334	26)	
740.337						<ul style="list-style-type: none"> ● VKHB 2162 ● VKHB 2161 ● VKHB 2146 ● VKHB 2161 	33021/Q 32019 X/Q 33021/QVB091 32019 X/Q	VKS 6183 VKS 6181 VKS 6334	25) 26)	
740.338-339						<ul style="list-style-type: none"> ● VKHB 2163 ● VKHB 2164 ● VKHB 2163 ● VKHB 2164 	33022 30220 J2 33022 30220 J2	VKS 6183 VKS 6181 VKS 6334	25) 26)	
740.340						<ul style="list-style-type: none"> ● VKHB 2162 ● VKHB 2161 	33021/Q 32019 X/Q	VKS 6183 VKS 6181	25)	





MERCEDES-BENZ "Baumuster" .../...

					<ul style="list-style-type: none"> ● VKHB 2146 ● VKHB 2161 	33021/QVB091 32019 X/Q	VKS 6334	26)
740.341					<ul style="list-style-type: none"> ● VKHB 2163 ● VKHB 2164 ● VKHB 2163 ● VKHB 2164 	33022 30220 J2 33022 30220 J2	VKS 6183 VKS 6181 VKS 6334	25) 26)
740.342					<ul style="list-style-type: none"> ● VKHB 2162 ● VKHB 2161 ● VKHB 2146 ● VKHB 2161 	33021/Q 32019 X/Q 33021/QVB091 32019 X/Q	VKS 6183 VKS 6181 VKS 6334	25) 26)
740.346					<ul style="list-style-type: none"> ● VKHB 2146 ● VKHB 2161 ● VKHB 2162 ● VKHB 2161 	33021/QVB091 32019 X/Q 33021/Q 32019 X/Q	VKS 6334 VKS 6183 VKS 6181	26) 25)
740.347					<ul style="list-style-type: none"> ● VKHB 2163 ● VKHB 2164 ● VKHB 2163 ● VKHB 2164 	33022 30220 J2 33022 30220 J2	VKS 6334 VKS 6183 VKS 6181	26) 25)
740.348					<ul style="list-style-type: none"> ● VKHB 2146 ● VKHB 2161 ● VKHB 2162 ● VKHB 2161 	33021/QVB091 32019 X/Q 33021/Q 32019 X/Q	VKS 6334 VKS 6183 VKS 6181	26) 25)
740.350-.351					<ul style="list-style-type: none"> ● VKHB 2163 ● VKHB 2164 ● VKHB 2163 ● VKHB 2164 	33022 30220 J2 33022 30220 J2	VKS 6183 VKS 6181 VKS 6334	25) 26)
740.352-.354					<ul style="list-style-type: none"> ● VKHB 2162 ● VKHB 2161 ● VKHB 2146 ● VKHB 2161 	33021/Q 32019 X/Q 33021/QVB091 32019 X/Q	VKS 6183 VKS 6181 VKS 6334	25) 26)
740.356-.357					<ul style="list-style-type: none"> ● VKHB 2146 ● VKHB 2161 ● VKHB 2162 ● VKHB 2161 	33021/QVB091 32019 X/Q 33021/Q 32019 X/Q	VKS 6334 VKS 6183 VKS 6181	26) 25)
740.364-.366					<ul style="list-style-type: none"> ● VKHB 2146 ● VKHB 2161 ● VKHB 2162 ● VKHB 2161 	33021/QVB091 32019 X/Q 33021/Q 32019 X/Q	VKS 6334 VKS 6183 VKS 6181	26) 25)

										
740.367-.368						<ul style="list-style-type: none"> ● VKHB 2163 ● VKHB 2164 ● VKHB 2163 ● VKHB 2164 	33022 30220 J2 33022 30220 J2	VKS 6183 VKS 6181 VKS 6334	25) 26)	
740.369						<ul style="list-style-type: none"> ● VKHB 2162 ● VKHB 2161 ● VKHB 2146 ● VKHB 2161 	33021/Q 32019 X/Q 33021/QVB091 32019 X/Q	VKS 6183 VKS 6181 VKS 6334	25) 26)	
740.370-.372						<ul style="list-style-type: none"> ● VKHB 2163 ● VKHB 2164 ● VKHB 2163 ● VKHB 2164 	33022 30220 J2 33022 30220 J2	VKS 6183 VKS 6181 VKS 6334	25) 26)	
740.374-.376						<ul style="list-style-type: none"> ● VKHB 2162 ● VKHB 2161 ● VKHB 2146 ● VKHB 2161 	33021/Q 32019 X/Q 33021/QVB091 32019 X/Q	VKS 6183 VKS 6181 VKS 6334	25) 26)	
740.380-.382						<ul style="list-style-type: none"> ● VKHB 2163 ● VKHB 2164 ● VKHB 2163 ● VKHB 2164 	33022 30220 J2 33022 30220 J2	VKS 6334 VKS 6183 VKS 6181	26) 25)	
740.383						<ul style="list-style-type: none"> ● VKHB 2146 ● VKHB 2161 ● VKHB 2162 ● VKHB 2161 	33021/QVB091 32019 X/Q 33021/Q 32019 X/Q	VKS 6334 VKS 6183 VKS 6181	26) 25)	
740.384-.385						<ul style="list-style-type: none"> ● VKHB 2163 ● VKHB 2164 ● VKHB 2163 ● VKHB 2164 	33022 30220 J2 33022 30220 J2	VKS 6183 VKS 6181 VKS 6334	25) 26)	
740.386						<ul style="list-style-type: none"> ● VKHB 2146 ● VKHB 2161 ● VKHB 2162 ● VKHB 2161 	33021/QVB091 32019 X/Q 33021/Q 32019 X/Q	VKS 6334 VKS 6183 VKS 6181	26) 25)	
740.387-.388						<ul style="list-style-type: none"> ● VKHB 2163 ● VKHB 2164 ● VKHB 2163 ● VKHB 2164 	33022 30220 J2 33022 30220 J2	VKS 6334 VKS 6183 VKS 6181	26) 25)	
740.392-.393						<ul style="list-style-type: none"> ● VKHB 2146 ● VKHB 2161 ● VKHB 2162 ● VKHB 2161 	33021/QVB091 32019 X/Q 33021/Q 32019 X/Q	VKS 6334 VKS 6183 VKS 6181	26) 25)	





MERCEDES-BENZ "Baumuster" .../...

740.394-.395

- VKHB 2163 33022 VKS 6183 25)
- VKHB 2164 30220 J2 VKS 6181
- VKHB 2163 33022 VKS 6334 26)
- VKHB 2164 30220 J2

740.396

- VKHB 2162 33021/Q VKS 6183 25)
- VKHB 2161 32019 X/Q VKS 6181
- VKHB 2146 33021/QVB091 VKS 6334 26)
- VKHB 2161 32019 X/Q

740.397

- VKHB 2163 33022 VKS 6183
- VKHB 2165 33220 VKS 6181

740.398

- VKHB 2163 33022 VKS 6183 25)
- VKHB 2164 30220 J2 VKS 6181
- VKHB 2163 33022 VKS 6334 26)
- VKHB 2164 30220 J2

740.500

- VKHB 2162 33021/Q VKS 6183 25)
- VKHB 2161 32019 X/Q VKS 6181
- VKHB 2146 33021/QVB091 VKS 6334 26)
- VKHB 2161 32019 X/Q

740.501

- VKHB 2163 33022 VKS 6183
- VKHB 2165 33220 VKS 6181

740.502

- VKHB 2163 33022 VKS 6334 26)
- VKHB 2164 30220 J2
- VKHB 2163 33022 VKS 6183 25)
- VKHB 2164 30220 J2 VKS 6181

740.530-.532

- VKHB 2163 33022 VKS 6183 25)
- VKHB 2164 30220 J2 VKS 6181
- VKHB 2163 33022 VKS 6334 26)
- VKHB 2164 30220 J2

740.536-.538











- VKHB 2163 33022 VKS 6183 25)
- VKHB 2164 30220 J2 VKS 6181
- VKHB 2163 33022 VKS 6334 26)
- VKHB 2164 30220 J2

740.539

- VKHB 2163 33022 VKS 6183
- VKHB 2165 33220 VKS 6181

740.540

- VKHB 2163 33022 VKS 6183 25)
- VKHB 2164 30220 J2 VKS 6181

										
						<ul style="list-style-type: none"> ● VKHB 2163 ● VKHB 2164 	33022 30220 J2	VKS 6334	26)	
740.544						<ul style="list-style-type: none"> ● VKHB 2163 ● VKHB 2165 	33022 33220	VKS 6183 VKS 6181		
740.545-.548						<ul style="list-style-type: none"> ● VKHB 2163 ● VKHB 2164 ● VKHB 2163 ● VKHB 2164 	33022 30220 J2 33022 30220 J2	VKS 6334 VKS 6183 VKS 6181	26) 25)	
740.901						<ul style="list-style-type: none"> ● VKHB 2162 ● VKHB 2161 ● VKHB 2146 ● VKHB 2161 	33021/Q 32019 X/Q 33021/QVB091 32019 X/Q	VKS 6183 VKS 6181 VKS 6334	25) 26)	
740.903-.906						<ul style="list-style-type: none"> ● VKHB 2162 ● VKHB 2161 ● VKHB 2146 ● VKHB 2161 	33021/Q 32019 X/Q 33021/QVB091 32019 X/Q	VKS 6183 VKS 6181 VKS 6334	25) 26)	
740.908						<ul style="list-style-type: none"> ● VKHB 2163 ● VKHB 2164 ● VKHB 2163 ● VKHB 2164 	33022 30220 J2 33022 30220 J2	VKS 6334 VKS 6183 VKS 6181	26) 25)	
740.909						<ul style="list-style-type: none"> ● VKHB 2146 ● VKHB 2161 	33021/QVB091 32019 X/Q	VKS 6334	26)	
740.909-.910						<ul style="list-style-type: none"> ● VKHB 2162 ● VKHB 2161 	33021/Q 32019 X/Q	VKS 6183 VKS 6181	25)	
740.910						<ul style="list-style-type: none"> ● VKHB 2051 ● VKHB 2065 	33213/Q 33208/Q	VKS 6157	26)	
740.911						<ul style="list-style-type: none"> ● VKHB 2163 ● VKHB 2164 ● VKHB 2163 ● VKHB 2164 	33022 30220 J2 33022 30220 J2	VKS 6334 VKS 6183 VKS 6181	26) 25)	
740.912						<ul style="list-style-type: none"> ● VKHB 2162 ● VKHB 2161 ● VKHB 2146 ● VKHB 2161 	33021/Q 32019 X/Q 33021/QVB091 32019 X/Q	VKS 6183 VKS 6181 VKS 6334	25) 26)	
740.914-.916						<ul style="list-style-type: none"> ● VKHB 2146 ● VKHB 2161 	33021/QVB091 32019 X/Q	VKS 6334	26)	





MERCEDES-BENZ "Baumuster" .../...

740.914-.920

● ● VKHB 2162 33021/Q VKS 6183 25)
● VKHB 2161 32019 X/Q VKS 6181

740.917

● ● VKHB 2051 33213/Q VKS 6157 26)
● VKHB 2065 33208/Q

740.918-.920

● ● VKHB 2146 33021/QVB091 VKS 6334 26)
● VKHB 2161 32019 X/Q

740.921-.929

● ● VKHB 2163 33022 VKS 6334 26)
● VKHB 2164 30220 J2
● ● VKHB 2163 33022 VKS 6183 25)
● VKHB 2164 30220 J2 VKS 6181

740.931

● ● VKHB 2163 33022 VKS 6334 26)
● VKHB 2164 30220 J2
● ● VKHB 2163 33022 VKS 6183 25)
● VKHB 2164 30220 J2 VKS 6181

740.932

● ● VKHB 2146 33021/QVB091 VKS 6334 26)
● VKHB 2161 32019 X/Q
● ● VKHB 2162 33021/Q VKS 6183 25)
● VKHB 2161 32019 X/Q VKS 6181

740.935

● ● VKHB 2163 33022 VKS 6183 25)
● VKHB 2164 30220 J2 VKS 6181
● ● VKHB 2163 33022 VKS 6334 26)
● VKHB 2164 30220 J2

740.936

● ● VKHB 2146 33021/QVB091 VKS 6334 26)
● VKHB 2161 32019 X/Q
● ● VKHB 2162 33021/Q VKS 6183 25)
● VKHB 2161 32019 X/Q VKS 6181

740.952-.953











● ● VKHB 2146 33021/QVB091 VKS 6334 26)
● VKHB 2161 32019 X/Q
● ● VKHB 2162 33021/Q VKS 6183 25)
● VKHB 2161 32019 X/Q VKS 6181

740.954

● ● VKHB 2163 33022 VKS 6183
● VKHB 2165 33220 VKS 6181

740.955

● ● VKHB 2163 33022 VKS 6334 26)
● VKHB 2164 30220 J2
● ● VKHB 2163 33022 VKS 6183 25)
● VKHB 2164 30220 J2 VKS 6181

									
740.956-.957					<ul style="list-style-type: none"> ● VKHB 2146 ● VKHB 2161 ● VKHB 2162 ● VKHB 2161 	33021/QVB091 32019 X/Q 33021/Q 32019 X/Q	VKS 6334 VKS 6183 VKS 6181	26) 25)	
740.958-.959					<ul style="list-style-type: none"> ● VKHB 2163 ● VKHB 2164 ● VKHB 2163 ● VKHB 2164 	33022 30220 J2 33022 30220 J2	VKS 6183 VKS 6181 VKS 6334	25) 26)	
740.960					<ul style="list-style-type: none"> ● VKHB 2162 ● VKHB 2161 ● VKHB 2146 ● VKHB 2161 	33021/Q 32019 X/Q 33021/QVB091 32019 X/Q	VKS 6183 VKS 6181 VKS 6334	25) 26)	
740.961-.963					<ul style="list-style-type: none"> ● VKHB 2163 ● VKHB 2164 ● VKHB 2163 ● VKHB 2164 	33022 30220 J2 33022 30220 J2	VKS 6334 VKS 6183 VKS 6181	26) 25)	
740.964					<ul style="list-style-type: none"> ● VKHB 2146 ● VKHB 2161 ● VKHB 2162 ● VKHB 2161 	33021/QVB091 32019 X/Q 33021/Q 32019 X/Q	VKS 6334 VKS 6183 VKS 6181	26) 25)	
740.965-.966					<ul style="list-style-type: none"> ● VKHB 2163 ● VKHB 2164 ● VKHB 2163 ● VKHB 2164 	33022 30220 J2 33022 30220 J2	VKS 6334 VKS 6183 VKS 6181	26) 25)	
740.968					<ul style="list-style-type: none"> ● VKHB 2163 ● VKHB 2164 ● VKHB 2163 ● VKHB 2164 	33022 30220 J2 33022 30220 J2	VKS 6334 VKS 6183 VKS 6181	26) 25)	
740.974					<ul style="list-style-type: none"> ● VKHB 2162 ● VKHB 2161 ● VKHB 2146 ● VKHB 2161 	33021/Q 32019 X/Q 33021/QVB091 32019 X/Q	VKS 6183 VKS 6181 VKS 6334	25) 26)	
741.200-.203, 741.300-.304, 741.330-.337					<ul style="list-style-type: none"> ● VKHB 2075 	33895/33822/Q			
741.400-.401, 741.404, 741.406, 741.436-.439			VKBA 1470		<ul style="list-style-type: none"> ● 			1)	
741.520-.521, 741.526-.530, 741.540					<ul style="list-style-type: none"> ● VKHB 2060 ● VKHB 2017 	32011 X/Q 32210 J2/Q	VKS 6159		





MERCEDES-BENZ "Baumuster" .../...

741.550, 741.559

-

VKHB 2234
VKHB 2017

32012 X/QCL7C
32210 J2/Q

VKS 6288

741.560, 741.570

-

VKHB 2154
VKHB 2060

32014 X/Q
32011 X/Q

VKS 6173

741.580

VKBA 5048

VKA 4103

-

VKHB 2155
VKHB 2156

331293/Q
33011/Q

VKS 6172

742.001-.002

-

VKHB 2075

33895/33822/Q

742.100

-

VKHB 2076
VKHB 2059

47490/47420
33111/Q

742.201-.204, 742.230

-

VKHB 2137
VKHB 2233

JM 714249/
210/Q
33112/QVB259

742.300

-

VKHB 2041
VKHB 2079

580/572/Q
330356 A/Q

VKS 6178

742.400, 742.410-.414

-

VKHB 2154
VKHB 2060

32014 X/Q
32011 X/Q

VKS 6173

742.420-.421, 742.430,
742.432-.443

VKBA 5048

VKA 4103

-

VKHB 2155
VKHB 2156

331293/Q
33011/Q

VKS 6172

742.450, 742.460-.462

-

VKHB 2137
VKHB 2233

JM 714249/
210/Q
33112/QVB259

VKS 6174

742.470-.471,
742.480-.487

VKBA 5048

VKA 4103

-

VKHB 2155
VKHB 2156

331293/Q
33011/Q

VKS 6172

742.503

VKBA 5048

VKA 4103

-

VKHB 2155
VKHB 2156

331293/Q
33011/Q

VKS 6172

37)

744.300-.302

-

VKHB 2041
VKHB 2079

580/572/Q
330356 A/Q











VKS 6178

744.303-.305

-

VKHB 2026
VKHB 2079

32216 J2/Q
330356 A/Q

									
744.309-.311, 744.330-.333					●	VKHB 2041 VKHB 2079	580/572/Q 330356 A/Q	VKS 6178	
744.334, 744.336-.338					●	VKHB 2026 VKHB 2079	32216 J2/Q 330356 A/Q		
744.339-.340					●	VKHB 2080 VKHB 2081	32217 J2/Q 331074/Q	VKS 6151	
744.341-.342, 744.344-.349					●	VKHB 2041 VKHB 2079	580/572/Q 330356 A/Q	VKS 6178	
744.351					●	VKHB 2026 VKHB 2079	32216 J2/Q 330356 A/Q		
744.352, 744.400-.402, 744.405, 744.407-.409, 744.412-.414, 744.430, 744.432-.433					●	VKHB 2080 VKHB 2081	32217 J2/Q 331074/Q	VKS 6151	
744.434			VKBA 5052		●	VKHB 2082 VKHB 2028	33019/Q 33215/Q	VKS 6154	
744.435-.437					●	VKHB 2080 VKHB 2081	32217 J2/Q 331074/Q	VKS 6151	
744.438			VKBA 5052		●	VKHB 2082 VKHB 2028	33019/Q 33215/Q	VKS 6154	
744.442-.443					●	VKHB 2080 VKHB 2081	32217 J2/Q 331074/Q	VKS 6151	
744.500-.502, 744.504-.508, 744.530-.532, 744.802-.804, 744.807-.810, 744.830-.835, 744.842, 744.845, 744.854-.856, 744.863, 744.868-.871, 744.876-.877			VKBA 5052		●	VKHB 2082 VKHB 2028	33019/Q 33215/Q	VKS 6154	
744.900, 744.902-.919					●	VKHB 2041 VKHB 2079	580/572/Q 330356 A/Q	VKS 6178	
744.920					●	VKHB 2158 VKHB 2081	33117/Q 331074/Q	VKS 6178	
744.921					●	VKHB 2082 VKHB 2028	33019/Q 33215/Q		



MERCEDES-BENZ "Baumuster" .../...

744.930, 744.932,
744.936-.940, 744.942

● VKHB 2158 33117/Q VKS 6178
● VKHB 2081 331074/Q

744.947-.949

● VKHB 2082 33019/Q
● VKHB 2028 33215/Q

744.950, 744.952-.955,
744.957-.960,
744.978-.979,
744.988-.989

● VKHB 2157 32016 X/Q VKS 6175
● VKHB 2159 33113/QVB022

745.100-.101,
745.104-.108

VKBA 5052 ● VKHB 2082 33019/Q VKS 6154
● VKHB 2028 33215/Q

745.109

● VKHB 2083 CK-598 A/
● VKHB 2033 K-592 A
32215 J2/Q

745.110-.114, 745.131

VKBA 5052 ● VKHB 2082 33019/Q VKS 6154
● VKHB 2028 33215/Q

745.139, 745.142

● VKHB 2083 CK-598 A/
● VKHB 2033 K-592 A
32215 J2/Q

745.143-.145,
745.147-.149

VKBA 5052 ● VKHB 2082 33019/Q VKS 6154
● VKHB 2028 33215/Q

745.600-.611,
745.613-.614, 745.616,
745.620-.625,
745.630-.639,
745.642-.650,
745.653-.657,
745.659-.661, 745.663,
745.666-.689,
745.700-.703,
745.730-.733,
745.736-.742,
745.750-.755, 745.774,
745.780-.787, 745.791,
745.799-.800

VKBA 5056 VKA 4110 ● VKHB 2124 33020/Q VKS 6176
● VKHB 2158 33117/Q

745.810, 745.812,
745.820, 745.822,
745.824-.827











● VKHB 2082 33019/Q
● VKHB 2028 33215/Q

745.880-.881

VKBA 5056 VKA 4110 ● VKHB 2124 33020/Q VKS 6176
● VKHB 2158 33117/Q

748.210-.211

VKBA 5370 ● VKHB 2163 33022 VKS 6334 30)
● VKHB 2165 33220
VKBA 5369 ● VKHB 2162 33021/Q VKS 6334 29)











										
						●	VKHB 2306	32020 X/Q		
748.214			VKBA 5370 VKBA 5369			● ●	VKHB 2163 VKHB 2165	33022 33220	VKS 6334	30)
						●	VKHB 2162 VKHB 2306	33021/Q 32020 X/Q	VKS 6334	29)
748.216			VKBA 5370 VKBA 5369			● ●	VKHB 2163 VKHB 2165	33022 33220	VKS 6334	30)
						●	VKHB 2162 VKHB 2306	33021/Q 32020 X/Q	VKS 6334	29)
748.218			VKBA 5369 VKBA 5370			● ●	VKHB 2162 VKHB 2306	33021/Q 32020 X/Q	VKS 6334	29)
						●	VKHB 2163 VKHB 2165	33022 33220	VKS 6334	30)
748.230			VKBA 5370 VKBA 5369			● ●	VKHB 2163 VKHB 2165	33022 33220	VKS 6334	30)
						●	VKHB 2162 VKHB 2306	33021/Q 32020 X/Q	VKS 6334	29)
748.234			VKBA 5370 VKBA 5369			● ●	VKHB 2163 VKHB 2165	33022 33220	VKS 6334	30)
						●	VKHB 2162 VKHB 2306	33021/Q 32020 X/Q	VKS 6334	29)
748.236			VKBA 5370 VKBA 5369			● ●	VKHB 2163 VKHB 2165	33022 33220	VKS 6334	30)
						●	VKHB 2162 VKHB 2306	33021/Q 32020 X/Q	VKS 6334	29)
748.238			VKBA 5370 VKBA 5369			● ●	VKHB 2163 VKHB 2165	33022 33220	VKS 6334	30)
						●	VKHB 2162 VKHB 2306	33021/Q 32020 X/Q	VKS 6334	29)
748.400-.401						● ●	VKHB 2162 VKHB 2161	33021/Q 32019 X/Q	VKS 6183 VKS 6181	25)
						●	VKHB 2146 VKHB 2161	33021/QVB091 32019 X/Q	VKS 6334	26)
748.402-.403						● ●	VKHB 2163 VKHB 2164	33022 30220 J2	VKS 6334	26)
						●	VKHB 2163 VKHB 2164	33022 30220 J2	VKS 6183 VKS 6181	25)
748.430-.433						●	VKHB 2146 VKHB 2161	33021/QVB091 32019 X/Q	VKS 6334	26)





MERCEDES-BENZ "Baumuster" .../...

				<ul style="list-style-type: none"> ● VKHB 2162 33021/Q ● VKHB 2161 32019 X/Q 	VKS 6183 VKS 6181	25)
748.434-.436				<ul style="list-style-type: none"> ● VKHB 2163 33022 ● VKHB 2164 30220 J2 ● VKHB 2163 33022 ● VKHB 2164 30220 J2 	VKS 6334 VKS 6183 VKS 6181	26) 25)
748.437-.439				<ul style="list-style-type: none"> ● VKHB 2162 33021/Q ● VKHB 2161 32019 X/Q ● VKHB 2146 33021/QVB091 ● VKHB 2161 32019 X/Q 	VKS 6183 VKS 6181 VKS 6334	25) 26)
748.440				<ul style="list-style-type: none"> ● VKHB 2163 33022 ● VKHB 2164 30220 J2 ● VKHB 2163 33022 ● VKHB 2164 30220 J2 	VKS 6183 VKS 6181 VKS 6334	25) 26)
748.441-.445				<ul style="list-style-type: none"> ● VKHB 2162 33021/Q ● VKHB 2161 32019 X/Q ● VKHB 2146 33021/QVB091 ● VKHB 2161 32019 X/Q 	VKS 6183 VKS 6181 VKS 6334	25) 26)
748.446-.448				<ul style="list-style-type: none"> ● VKHB 2163 33022 ● VKHB 2164 30220 J2 ● VKHB 2163 33022 ● VKHB 2164 30220 J2 	VKS 6183 VKS 6181 VKS 6334	25) 26)
748.449-.451				<ul style="list-style-type: none"> ● VKHB 2146 33021/QVB091 ● VKHB 2161 32019 X/Q ● VKHB 2162 33021/Q ● VKHB 2161 32019 X/Q 	VKS 6334 VKS 6183 VKS 6181	26) 25)
748.452-.454				<ul style="list-style-type: none"> ● VKHB 2163 33022 ● VKHB 2164 30220 J2 ● VKHB 2163 33022 ● VKHB 2164 30220 J2 	VKS 6334 VKS 6183 VKS 6181	26) 25)
748.455-.459				<ul style="list-style-type: none"> ● VKHB 2162 33021/Q ● VKHB 2161 32019 X/Q ● VKHB 2146 33021/QVB091 ● VKHB 2161 32019 X/Q 	VKS 6183 VKS 6181 VKS 6334	25) 26)
748.460-.462				<ul style="list-style-type: none"> ● VKHB 2163 33022 ● VKHB 2164 30220 J2 ● VKHB 2163 33022 ● VKHB 2164 30220 J2 	VKS 6183 VKS 6181 VKS 6334	25) 26)











										
748.463						<ul style="list-style-type: none"> ● VKHB 2146 ● VKHB 2161 ● VKHB 2162 ● VKHB 2161 	33021/QVB091 32019 X/Q	VKS 6334	26)	
						<ul style="list-style-type: none"> ● VKHB 2162 ● VKHB 2161 	33021/Q 32019 X/Q	VKS 6183 VKS 6181	25)	
748.464						<ul style="list-style-type: none"> ● VKHB 2163 ● VKHB 2164 ● VKHB 2163 ● VKHB 2164 	33022 30220 J2	VKS 6183 VKS 6181	25)	
						<ul style="list-style-type: none"> ● VKHB 2163 ● VKHB 2164 	33022 30220 J2	VKS 6334	26)	
748.465						<ul style="list-style-type: none"> ● VKHB 2146 ● VKHB 2161 ● VKHB 2162 ● VKHB 2161 	33021/QVB091 32019 X/Q	VKS 6334	26)	
						<ul style="list-style-type: none"> ● VKHB 2162 ● VKHB 2161 	33021/Q 32019 X/Q	VKS 6183 VKS 6181	25)	
748.466-.468						<ul style="list-style-type: none"> ● VKHB 2163 ● VKHB 2164 ● VKHB 2163 ● VKHB 2164 	33022 30220 J2	VKS 6334	26)	
						<ul style="list-style-type: none"> ● VKHB 2163 ● VKHB 2164 	33022 30220 J2	VKS 6183 VKS 6181	25)	
748.469-.470						<ul style="list-style-type: none"> ● VKHB 2162 ● VKHB 2161 ● VKHB 2146 ● VKHB 2161 	33021/Q 32019 X/Q	VKS 6183 VKS 6181	25)	
						<ul style="list-style-type: none"> ● VKHB 2146 ● VKHB 2161 	33021/QVB091 32019 X/Q	VKS 6334	26)	
748.471						<ul style="list-style-type: none"> ● VKHB 2163 ● VKHB 2164 ● VKHB 2163 ● VKHB 2164 	33022 30220 J2	VKS 6334	26)	
						<ul style="list-style-type: none"> ● VKHB 2163 ● VKHB 2164 	33022 30220 J2	VKS 6183 VKS 6181	25)	
748.590			VKBA 5401			<ul style="list-style-type: none"> ● VKHB 2163 ● VKHB 2329 	33022 KHM.220110/ 567549	VKS 6353		
748.900-.901						<ul style="list-style-type: none"> ● VKHB 2146 ● VKHB 2161 ● VKHB 2162 ● VKHB 2161 	33021/QVB091 32019 X/Q	VKS 6334	26)	
						<ul style="list-style-type: none"> ● VKHB 2162 ● VKHB 2161 	33021/Q 32019 X/Q	VKS 6183 VKS 6181	25)	
748.902, 748.904-.907						<ul style="list-style-type: none"> ● VKHB 2162 ● VKHB 2082 	33021/Q 33019/Q	VKS 6183 VKS 6181		
748.908						<ul style="list-style-type: none"> ● VKHB 2146 ● VKHB 2161 ● VKHB 2162 ● VKHB 2161 	33021/QVB091 32019 X/Q	VKS 6334	26)	
						<ul style="list-style-type: none"> ● VKHB 2162 ● VKHB 2161 	33021/Q 32019 X/Q	VKS 6183 VKS 6181	25)	
748.910						<ul style="list-style-type: none"> ● VKHB 2146 ● VKHB 2161 	33021/QVB091 32019 X/Q	VKS 6334	26)	





MERCEDES-BENZ "Baumuster" .../...

				<ul style="list-style-type: none"> ● VKHB 2162 33021/Q VKS 6183 25) ● VKHB 2161 32019 X/Q VKS 6181
748.911				<ul style="list-style-type: none"> ● VKHB 2162 33021/Q VKS 6183 ● VKHB 2082 33019/Q VKS 6181
748.912				<ul style="list-style-type: none"> ● VKHB 2146 33021/QVB091 VKS 6334 26) ● VKHB 2161 32019 X/Q ● VKHB 2162 33021/Q VKS 6183 25) ● VKHB 2161 32019 X/Q VKS 6181
748.913-.922, 748.925-.930, 748.932-.933, 748.936				<ul style="list-style-type: none"> ● VKHB 2162 33021/Q VKS 6183 ● VKHB 2082 33019/Q VKS 6181
748.990-.999				<ul style="list-style-type: none"> ● VKHB 2146 33021/QVB091 VKS 6334 26) ● VKHB 2161 32019 X/Q ● VKHB 2162 33021/Q VKS 6183 25) ● VKHB 2161 32019 X/Q VKS 6181
749.000				<ul style="list-style-type: none"> ● VKHB 2070 32310 J2/Q
749.001, 749.003-.004				<ul style="list-style-type: none"> ● VKHB 2071 332330 B/Q VKS 6158 ● VKHB 2068 33210/Q VKS 6146
749.005		VKBA 5052		<ul style="list-style-type: none"> ● VKHB 2082 33019/Q VKS 6154 ● VKHB 2028 33215/Q
749.006				<ul style="list-style-type: none"> ● VKHB 2071 332330 B/Q VKS 6158 ● VKHB 2068 33210/Q VKS 6146
749.007		VKBA 5052		<ul style="list-style-type: none"> ● VKHB 2082 33019/Q VKS 6154 ● VKHB 2028 33215/Q
749.010				<ul style="list-style-type: none"> ● VKHB 2071 332330 B/Q VKS 6158 ● VKHB 2068 33210/Q VKS 6146
749.011				<ul style="list-style-type: none"> ● VKHB 2124 33020/Q VKS 6150 ● VKHB 2326 33116/Q
749.031-.036				<ul style="list-style-type: none"> ● VKHB 2071 332330 B/Q VKS 6158 ● VKHB 2068 33210/Q VKS 6146

										
749.100-.101						●	VKHB 2070	32310 J2/Q		
749.102-.103, 749.105-.107			VKBA 5038	VKA 4094	●	●	VKHB 2071 VKHB 2070	332330 B/Q 32310 J2/Q	VKS 6158 VKS 6146	
749.108			VKBA 5375		●	●	VKHB 2280 VKHB 2003	BT1-0084/Q 32312 J2/Q	VKS 6315 VKS 6150 VKS 6146	
749.130-.141			VKBA 5038	VKA 4094	●	●	VKHB 2071 VKHB 2070	332330 B/Q 32310 J2/Q	VKS 6158 VKS 6146	
749.300-.301			VKBA 5548		●	●	VKHB 2225 VKHB 2002	33217/Q 32311 J2	VKS 6150	
770.000-.003					●	●	VKHB 2321 VKHB 2044	33017/Q 33014	VKS 6350	38)
					●	●	VKHB 2124 VKHB 2326	33020/Q 33116/Q	VKS 6351	39)
					●	●	VKHB 2082 VKHB 2170	33019/Q 32018 X/Q	VKS 6352	40)
					●	●	VKHB 2041 VKHB 2328	580/572/Q 504376 A	VKS 6178	41)
OPEL										
MOVANO, 1.9 DTI	●		VKBA 3500		●	●				1)
	●		VKBA 3613		●	●				2)
MOVANO	●		VKBA 3613		●	●				3)
MOVANO, 2.8 DTI	●		VKBA 3500		●	●				4)
	●		VKBA 3500		●	●				5)
MOVANO, 2.8 DTI	●		VKBA 3613		●	●				6)
	●		VKBA 3613		●	●				7)
MOVANO	○		VKBA 3501		●	●				8)
	○		VKBA 3614		●	●				9)











OPEL .../...

VIVARO	•		VKBA 3616	•			10)
	•		VKBA 3618	•			11)
	○		VKBA 3617	•			13)

PEUGOET

Boxer 1.9 D, 1.9 TD, 2.0 HDI, 2.0 i	•		VKBA 1444	•			19)
Boxer 1.9 D, 1.9 TD, 2.0 HDI, 2.0 i	•		VKBA 3640	•			21)
Boxer 1.9 D, 1.9 TD, 2.0 HDI, 2.0 i	•		VKBA 3428	•			20)
	•		VKBA 3641	•			22)
Boxer 2.0, 2.0 Hdi, 2.2 Hdi	•		VKBA 3640	•			23)
	•		VKBA 3641	•			24)
Boxer 2.5 D, 2.5 TD, 2.5 TDI, 2.8 HDI	•		VKBA 1444	•			19)
	•		VKBA 3428	•			20)
	•		VKBA 3640	•			21)
	•		VKBA 3641	•			22)
Boxer 2.8 HDi	•		VKBA 3640	•			23)
	•		VKBA 3641	•			24)
Boxer 4X4: 1.9 TD, 2.0 i, 2.5 D, 2.5 TD, 2.5 TDI	•		VKBA 1444	•			25)
	•		VKBA 3428	•			26)
	•		VKBA 3640	•			27)
	•		VKBA 3641	•			28)

									
Boxer 4X4: 2.8 Hdi	•			VKBA 3640		•			23)
	•			VKBA 3641		•			24)
Boxer 1.9 D, 1.9 TD, 2,0 HDI, 2.0 i		○		VKBA 3429		•			19)
		○		VKBA 3430		•			20)
Boxer 1.9 D, 1.9 TD, 2,0HDI, 2.0 i		○		VKBA 3642		•			29)
Boxer 2.0, 2.0 Hdi, 2.2 Hdi		○		VKBA 3642		•			30)
Boxer 2.5 D, 2.5 TD, 2.5 TDI, 2.8 HDI		○		VKBA 3429		•			19)
		○		VKBA 3430		•			20)
		○		VKBA 3642		•			29)
Boxer 2.8 HDI		○		VKBA 3642		•			30)
		○		VKBA 3429		•			32)
		○		VKBA 3430		•			33)
Boxer 4X4: 1.9 TD, 2.0 i, 2.5 D, 2.5 TD, 2.5 TDI		○		VKBA 1444		•			34)
J 5 1.8, 2.0	•			VKBA 844		•			1)
J 5	•			VKBA 1444		•			2)
J 5 2.0, 2.5 D	•			VKBA 844		•			3)
J 5	•			VKBA 1444		•			4)
J 5 4X4	•			VKBA 1444		•			2)





PEUGOET .../...

J 5	<input type="radio"/>	VKBA 845	•	5)
	<input type="radio"/>	VKBA 1445	•	6)
J 5	<input type="radio"/>	VKBA 1462	•	7)
J 5	<input type="radio"/>	VKBA 1446	•	8)
	<input type="radio"/>	VKBA 1463	•	9)
J 5 1.8	<input type="radio"/>	VKBA 1445	•	10)
J 5	<input type="radio"/>	VKBA 846	•	11)
J 5 1.8	<input type="radio"/>	VKBA 1446	•	12)
J 5 1.9 D, 2.0, 2.5 TD	<input type="radio"/>	VKBA 1445	•	13)
	<input type="radio"/>	VKBA 1446	•	14)
J 5 2.0, 2.5 D	<input type="radio"/>	VKBA 1445	•	36)
	<input type="radio"/>	VKBA 1446	•	37)
J 5 4X4	<input type="radio"/>	VKBA 1312	•	2)
J 7	<input checked="" type="radio"/>	VKBA 804	•	16)
J 9	<input checked="" type="radio"/>	VKBA 804	•	18)



RENAULT (RVI)

MASTER I	•		VKBA 829	•			128)
	•		VKBA 847	•			129)
		○	VKBA 828	•			128)
		○	VKBA 848	•			129)
MASTER II	•		VKBA 3500	•			130)
MASTER II	•		VKBA 3613	•			131)
MASTER II, 2.5 D (ED0A, FD0A, HD0A, HD1A, JD0A, JD1A, UD0A, UD1A, UD4A)	•		VKBA 3500	•			132)
MASTER II, 2.8 dTi (FD2B, JD0B, JD1B)	•		VKBA 3500	•			133)
MASTER II, 2.8 dTi (FD0F, FD0R, FD3F, HD0F, HD1F, UD0F, UD1F, UD4F)	•		VKBA 3613	•			134)
MASTER II, 1.9 dTi (FD0L, FD0P)		○	VKBA 3501	•			135)
		○	VKBA 3614	•			136)
MASTER II, 1.9 dTi (JD0L, JD1L, JD1P)		○	VKBA 3501	•			137)
		○	VKBA 3614	•			138)
MASTER II, 2.2 dCi 90 (FD0G, FD0N, FD2N, FD3G, FD3N)		○	VKBA 3501	•			135)
		○	VKBA 3614	•			136)
MASTER II, 2.2 dCi 90 (JD0G, JD0N, JD1G, JD1N)		○	VKBA 3501	•			137)
		○	VKBA 3614	•			138)















RENAULT (RVI)

.../...

MASTER II, 2.2 dCi 90 (ED0G, ED0N, HD0G, HD0N, HD1G, HD1N, UD0G, UD0N, UD1G, UD1N, UD4G, UD4N)	<input type="radio"/>	VKBA 3501	•	139)
	<input type="radio"/>	VKBA 3614	•	140)
MASTER II, 2.5 D (FD0A, FD0E, FD2E, FD3E)	<input type="radio"/>	VKBA 3501	•	141)
	<input type="radio"/>	VKBA 3614	•	142)
MASTER II, 2.5 dCi 120 (FD0M, FD0U, FD0V, FD2M, FD3M, FD3U, FD3V, FD8M, FD8V)	<input type="radio"/>	VKBA 3501	•	147)
	<input type="radio"/>	VKBA 3614	•	148)
MASTER II, 2.5 D (JD0A, JD0E, JD1A, JD1E)	<input type="radio"/>	VKBA 3501	•	145)
	<input type="radio"/>	VKBA 3614	•	146)
MASTER II, 2.5 dCi 120 (JD0M, JD1M)	<input type="radio"/>	VKBA 3501	•	147)
	<input type="radio"/>	VKBA 3614	•	148)
MASTER II, 2.5 D (ED0A, ED0E, HD0A, HD0E, HD1A, HD1E, UD0A, UD0E, UD1A, UD1E, UD4A, UD4E)	<input type="radio"/>	VKBA 3501	•	149)
	<input type="radio"/>	VKBA 3614	•	150)
MASTER II, 2.5 dCi 120 (ED0M, ED0U, ED0V, ED8U, ED8V, HD0M, HD0U, HD0V, HD1M, HD1U, HD1V, UD0M, UD0V, UD1M, UD1U, UD1V, UD4M, UD4U, UD8V)	<input type="radio"/>	VKBA 3501	•	151)
	<input type="radio"/>	VKBA 3614	•	152)
MASTER II, 2.8 dTi (FD0C, FD0F, FD0R, FD2B, FD2F, FD3C, FD3F)	<input type="radio"/>	VKBA 3501	•	153)
	<input type="radio"/>	VKBA 3614	•	154)
MASTER II, 2.8 dTi (JD0B, JD0F, JD1B, JD1F)	<input type="radio"/>	VKBA 3501	•	153)
	<input type="radio"/>	VKBA 3614	•	154)











									
MASTER II, 2.8 dTi (ED0C, ED0F, HD0C, HD1C, HD1F, UD0C, UD0F, UD1C, UD1F, UD4C, UD4F)	<input type="radio"/>		VKBA 3501		•				155)
	<input type="radio"/>		VKBA 3614		•				156)
MASTER II, 3.0 dCi 140 (FD0S, FD2T, FD3S)	<input type="radio"/>		VKBA 3501		•				157)
	<input type="radio"/>		VKBA 3614		•				158)
MASTER II, 3.0 dCi 140 (JD0T, JD1T)	<input type="radio"/>		VKBA 3501		•				159)
	<input type="radio"/>		VKBA 3614		•				160)
MASTER II, 3.0 dCi 140 (ED0S, ED8S, HD1S, UD0S, UD1S, UD4F, UD8S)	<input type="radio"/>		VKBA 3501		•				161)
	<input type="radio"/>		VKBA 3614		•				162)
Trafic I	<input checked="" type="radio"/>		VKBA 909		•				100)
	<input checked="" type="radio"/>		VKBA 908		•				101)
4x4: Trafic I	<input checked="" type="radio"/>		VKBA 909		•				113)
Trafic I	<input type="radio"/>		VKBA 977		•				114)
4x4: Trafic I	<input type="radio"/>		VKBA 849		•				115)
Trafic I	<input type="radio"/>		VKBA 849		•				101)
	<input type="radio"/>		VKBA 830		•				116)
	<input type="radio"/>		VKBA 977		•				117)
4x4: Trafic I	<input type="radio"/>		VKBA 848		•				118)
Trafic I	<input type="radio"/>		VKBA 828		•				96)
	<input type="radio"/>		VKBA 3407		•				97)
Trafic II	<input checked="" type="radio"/>		VKBA 908		•				98)





RENAULT (RVI) .../...

	●		VKBA 909		● ●			119)
4x4: Trafic II	●		VKBA 909		● ●			120)
	○		VKBA 848		● ●			120)
Trafic II	○		VKBA 848		● ●			121)
	○		VKBA 828		● ●			122)
	○		VKBA 3407		● ●			123)
Trafic III	●		VKBA 3616		● ●			124)
	●		VKBA 3618		● ●			125)
	●		VKBA 3648		● ●			126)
	○		VKBA 3617		● ●			127)
Magnum 390/430/470/ 560	●	E 81	VKBA 5308		● ●			72)
	○	1341			● ●	VKHB 2192 VKHB 2194	JF 9549/9510 33216/Q	VKS 6201
	○	11 E/F	VKBA 5504	VKA 4202	● ●	VKHB 2029	HM 218248/W/ 2A/210/2A/Q	VKS 6205 103)
	○	840 A			● ●	VKHB 2051	33213/Q	
	○	1345			● ●	VKHB 2161 VKHB 2158	32019 X/Q 33117/Q	VKS 6201 104)
	○	1370			● ●	VKHB 2192 VKHB 2337	JF 9549/9510 JT 9049/9010	VKS 6201
	○	1370			● ●	VKHB 2192 VKHB 2158	JF 9549/9510 33117/Q	VKS 6201
Magnum 400/440/480 E-TECH	○	840 A			● ●	VKHB 2161 VKHB 2158	32019 X/Q 33117/Q	VKS 6201
	○	1341			● ●	VKHB 2192 VKHB 2194	JF 9549/9510 33216/Q	VKS 6201
	○	1370			● ●	VKHB 2192 VKHB 2158	JF 9549/9510 33117/Q	VKS 6201
	○	1345			● ●	VKHB 2192 VKHB 2337	JF 9549/9510 JT 9049/9010	VKS 6201
Magnum E-TECH	○	840 A			● ●	VKHB 2161 VKHB 2158	32019 X/Q 33117/Q	VKS 6201

									
	<ul style="list-style-type: none"> ○ 1341 ○ 1370 ○ 1345 				<ul style="list-style-type: none"> ● VKHB 2192 ● VKHB 2194 ● VKHB 2192 ● VKHB 2158 ● VKHB 2192 ● VKHB 2337 	<ul style="list-style-type: none"> JF 9549/9510 33216/Q JF 9549/9510 33117/Q JF 9549/9510 JT 9049/9010 		<ul style="list-style-type: none"> VKS 6201 VKS 6201 VKS 6201 	
110.130 6x6	<ul style="list-style-type: none"> ● MDRFP 4000 ○ MRFP 4000 				<ul style="list-style-type: none"> ● VKHB 2044 ● VKHB 2154 ● VKHB 2044 ● VKHB 2154 	<ul style="list-style-type: none"> 33014 32014 X/Q 33014 32014 X/Q 			
110.150 4x4	<ul style="list-style-type: none"> ● SINPAR MD 3000 ● SINPAR MD 3000 ● SINPAR MD 4000 ● 3MRDIF-155/ 156/158/171/ 214/216/219 ● 3MRDIF-8274 ● 3MRDIS-8500 FW ○ P 620 D1 ○ P 620 F ○ P 1021 K 				<ul style="list-style-type: none"> ● VKHB 2046 ● VKHB 2282 ● VKHB 2044 ● VKHB 2154 ● VKHB 2170 ● VKHB 2170 ● VKHB 2282 ● VKHB 2169 ● VKHB 2169 ● VKHB 2169 ● VKHB 2169 ● VKHB 2044 ● VKHB 2140 ● VKHB 2048 ● VKHB 2046 ● ● 	<ul style="list-style-type: none"> 33015/Q 32015 X/Q 33014 32014 X/Q 32018 X/Q 32018 X/Q 32015 X/Q 32017 X/Q 32017 X/Q 32017 X/Q 32017 X/Q 33014 33016/Q 33018/Q 33015/Q 		<ul style="list-style-type: none"> 82) 83) 41) 41) 41) 41) 41) 41) 41) 41) 41) 41) 41) 41) 41) 	
110/150, 110/170 4x4	<ul style="list-style-type: none"> ● E 408-05 ○ P821, P 1021 				<ul style="list-style-type: none"> ● VKHB 2061 ● VKHB 2065 ● ● 	<ul style="list-style-type: none"> 33211/Q 33208/Q 		<ul style="list-style-type: none"> VKS 6239 VKS 6234 	
110.170 4x4	<ul style="list-style-type: none"> ● SINPAR MD 3000 ● SINPAR MD 3000 ● SINPAR MD 4000 ● 3MRDIF-155/ 156/158/171/ 214/216/219 ● 3MRDIF-8274 ● 3MRDIS-8500 F W 				<ul style="list-style-type: none"> ● VKHB 2046 ● VKHB 2282 ● VKHB 2044 ● VKHB 2154 ● VKHB 2170 ● VKHB 2170 ● VKHB 2282 ● VKHB 2169 ● VKHB 2169 ● VKHB 2169 ● VKHB 2169 ● VKHB 2169 ● VKHB 2169 ● VKHB 2169 	<ul style="list-style-type: none"> 33015/Q 32015 X/Q 33014 32014 X/Q 32018 X/Q 32018 X/Q 32015 X/Q 32017 X/Q 32017 X/Q 32017 X/Q 32017 X/Q 32017 X/Q 32017 X/Q 32017 X/Q 		<ul style="list-style-type: none"> 82) 83) 41) 41) 41) 41) 41) 	





RENAULT (RVI) .../...

	<ul style="list-style-type: none"> ○ P 620 D1 ○ P 620 F ○ P 1021 K 			<ul style="list-style-type: none"> ● ● ● ● ● 	<ul style="list-style-type: none"> VKHB 2044 VKHB 2140 VKHB 2048 VKHB 2046 	<ul style="list-style-type: none"> 33014 33016/Q 33018/Q 33015/Q 	<ul style="list-style-type: none"> VKS 6234 VKS 6234 	<ul style="list-style-type: none"> 41) 41) 41)
130 B6/B6A	<ul style="list-style-type: none"> ● 401 ○ SOMA 95 			<ul style="list-style-type: none"> ● ● ● ● 	<ul style="list-style-type: none"> VKHB 2017 VKHB 2018 VKHB 2046 VKHB 2047 	<ul style="list-style-type: none"> 32210 J2/Q 32207 J2/Q 33015/Q 33013/Q 	<ul style="list-style-type: none"> VKS 6235 VKS 6237 VKS 6236 	
130 B9/B9A	<ul style="list-style-type: none"> ● 401 ○ SOMA 95 			<ul style="list-style-type: none"> ● ● ● ● 	<ul style="list-style-type: none"> VKHB 2017 VKHB 2018 VKHB 2046 VKHB 2047 	<ul style="list-style-type: none"> 32210 J2/Q 32207 J2/Q 33015/Q 33013/Q 	<ul style="list-style-type: none"> VKS 6235 VKS 6237 VKS 6236 	
130 B11/B13/B14	<ul style="list-style-type: none"> ● ○ 15 M, 15 MHD, 17 M ○ 467-26 ○ P 620 F/F1 ○ P 821 F/F1 			<ul style="list-style-type: none"> ● ● ● ● ● ● ● 	<ul style="list-style-type: none"> VKHB 2019 VKHB 2020 VKHB 2048 VKHB 2046 VKHB 2048 VKHB 2046 VKHB 2048 VKHB 2046 	<ul style="list-style-type: none"> 32211 J2/Q 32208 J2/Q 33018/Q 33015/Q 33018/Q 33015/Q 33018/Q 33015/Q 	<ul style="list-style-type: none"> VKS 6239 VKS 6233 VKS 6233 VKS 6233 VKS 6233 VKS 6233 	<ul style="list-style-type: none"> 14) 14)
150 B11/ B13	<ul style="list-style-type: none"> ● ○ 15 M, 15 MHD, 17 M ○ 467-26 ○ P 620 F/F1 ○ P 821 F/F1 			<ul style="list-style-type: none"> ● ● ● ● ● ● ● 	<ul style="list-style-type: none"> VKHB 2019 VKHB 2020 VKHB 2048 VKHB 2046 VKHB 2048 VKHB 2046 VKHB 2048 VKHB 2046 	<ul style="list-style-type: none"> 32211 J2/Q 32208 J2/Q 33018/Q 33015/Q 33018/Q 33015/Q 33018/Q 33015/Q 	<ul style="list-style-type: none"> VKS 6239 VKS 6233 VKS 6233 VKS 6233 VKS 6233 VKS 6233 	<ul style="list-style-type: none"> 14) 14)
75.130 4x4	<ul style="list-style-type: none"> ● SINPAR MD 3000 ● SINPAR MD 3000 ● SINPAR MD 4000 ● 3MRDIF-155/156/158/171/214/216/219 ● 3MRDIF-8274 			<ul style="list-style-type: none"> ● ● ● ● ● ● ● 	<ul style="list-style-type: none"> VKHB 2046 VKHB 2282 VKHB 2044 VKHB 2154 VKHB 2170 VKHB 2170 VKHB 2282 VKHB 2169 VKHB 2169 	<ul style="list-style-type: none"> 33015/Q 32015 X/Q 33014 32014 X/Q 32018 X/Q 32018 X/Q 32015 X/Q 32017 X/Q 32017 X/Q 	<ul style="list-style-type: none"> 82) 83) 41) 41) 41) 	













	<ul style="list-style-type: none"> ● 	3MRDIS-8500 F W			<ul style="list-style-type: none"> ● 	VKHB 2169 32017 X/Q		
	<ul style="list-style-type: none"> ○ 	P 620 D1			<ul style="list-style-type: none"> ● 	VKHB 2169 32017 X/Q VKHB 2169 32017 X/Q		41)
	<ul style="list-style-type: none"> ○ 	P 620 F			<ul style="list-style-type: none"> ● 	VKHB 2044 33014 VKHB 2140 33016/Q		41)
	<ul style="list-style-type: none"> ○ 	P 1021 K			<ul style="list-style-type: none"> ● 	VKHB 2048 33018/Q VKHB 2046 33015/Q	VKS 6234	41)
	<ul style="list-style-type: none"> ● 				<ul style="list-style-type: none"> ● 			VKS 6234 41)
770 KB6	<ul style="list-style-type: none"> ● 	E3A-10			<ul style="list-style-type: none"> ● 	VKHB 2173 33212/Q VKHB 2056 33109/Q		
	<ul style="list-style-type: none"> ● 	E3A-11			<ul style="list-style-type: none"> ● 	VKHB 2173 33212/Q VKHB 2056 33109/Q		
	<ul style="list-style-type: none"> ○ 	P 620 D1			<ul style="list-style-type: none"> ● 	VKHB 2044 33014 VKHB 2140 33016/Q		
	<ul style="list-style-type: none"> ○ 	P 621 B1			<ul style="list-style-type: none"> ● 	VKHB 2140 33016/Q		
85.150 4x4	<ul style="list-style-type: none"> ● 	SINPAR MD 3000			<ul style="list-style-type: none"> ● 	VKHB 2046 33015/Q VKHB 2282 32015 X/Q		82)
	<ul style="list-style-type: none"> ● 	SINPAR MD 3000			<ul style="list-style-type: none"> ● 	VKHB 2044 33014 VKHB 2154 32014 X/Q		83)
	<ul style="list-style-type: none"> ● 	SINPAR MD 4000			<ul style="list-style-type: none"> ● 	VKHB 2170 32018 X/Q VKHB 2170 32018 X/Q		
	<ul style="list-style-type: none"> ● 	3MRDIF-155/ 156/158/171/ 214/216/219			<ul style="list-style-type: none"> ● 	VKHB 2282 32015 X/Q VKHB 2169 32017 X/Q		41)
	<ul style="list-style-type: none"> ● 	3MRDIF-8274			<ul style="list-style-type: none"> ● 	VKHB 2169 32017 X/Q VKHB 2169 32017 X/Q		41)
	<ul style="list-style-type: none"> ● 	3MRDIS-8500 F W			<ul style="list-style-type: none"> ● 	VKHB 2169 32017 X/Q VKHB 2169 32017 X/Q		41)
	<ul style="list-style-type: none"> ○ 	P 620 D1			<ul style="list-style-type: none"> ● 	VKHB 2044 33014 VKHB 2140 33016/Q		41)
	<ul style="list-style-type: none"> ○ 	P 620 F			<ul style="list-style-type: none"> ● 	VKHB 2048 33018/Q VKHB 2046 33015/Q	VKS 6234	41)
	<ul style="list-style-type: none"> ○ 	P 1021 K			<ul style="list-style-type: none"> ● 		VKS 6234	41)
85/150 4x4	<ul style="list-style-type: none"> ● 	E 408-05			<ul style="list-style-type: none"> ● 	VKHB 2061 33211/Q VKHB 2065 33208/Q	VKS 6239	
	<ul style="list-style-type: none"> ○ 	P 821, P 1021			<ul style="list-style-type: none"> ● 		VKS 6234	
90 B6/B6A/B6Z/B7	<ul style="list-style-type: none"> ● 				<ul style="list-style-type: none"> ● 	VKHB 2067 33209/Q VKHB 2016 32206 J2/Q		12)
	<ul style="list-style-type: none"> ● 				<ul style="list-style-type: none"> ● 	VKHB 2067 33209/Q VKHB 2179 33206/Q		13)
	<ul style="list-style-type: none"> ○ 	669-01			<ul style="list-style-type: none"> ● 	VKHB 2044 33014	VKS 6237	



RENAULT (RVI)

.../...

	○ 70 HD		●	VKHB 2045	33012/Q	VKS 6219	
			●	VKHB 2044	33014	VKS 6237	
			●	VKHB 2045	33012/Q		
90 B8	● 401		●	VKHB 2017	32210 J2/Q	VKS 6235	
			●	VKHB 2018	32207 J2/Q		
	○ SOMA 95		●	VKHB 2046	33015/Q	VKS 6237	
			●	VKHB 2047	33013/Q	VKS 6236	
95.130 4x4	● SINPAR MD 3000		●	VKHB 2046	33015/Q		82)
			●	VKHB 2282	32015 X/Q		
	● SINPAR MD 3000		●	VKHB 2044	33014		83)
			●	VKHB 2154	32014 X/Q		
	● SINPAR MD 4000		●	VKHB 2170	32018 X/Q		41)
			●	VKHB 2170	32018 X/Q		
	● 3MRDIF-155/ 156/158/171/ 214/216/219		●	VKHB 2282	32015 X/Q		41)
			●	VKHB 2169	32017 X/Q		
	● 3MRDIF-8274		●	VKHB 2169	32017 X/Q		41)
			●	VKHB 2169	32017 X/Q		
	● 3MRDIS-8500 F W		●	VKHB 2169	32017 X/Q		41)
			●	VKHB 2169	32017 X/Q		
	○ P 620 D1		●	VKHB 2044	33014		41)
			●	VKHB 2140	33016/Q		
	○ P 620 F		●	VKHB 2048	33018/Q	VKS 6234	41)
			●	VKHB 2046	33015/Q		
	○ P 1021 K		●			VKS 6234	41)
			●				
B 110 (4x2)	●		●	VKHB 2190	33108/Q		67)
			●	VKHB 2057	33205/QVQ077		
	●		●	VKHB 2190	33108/Q		68)
			●	VKHB 2294	32305 J2		
	○ 569-01-39		●	VKHB 2060	32011 X/Q	VKS 6238	46)
			●	VKHB 2191	32010 X/Q	VKS 6229	
B 110 (4x4)	●		●	VKHB 2199	32013 X/Q		46)
			●	VKHB 2060	32011 X/Q		
	● 569-10		●	VKHB 2234	32012 X/QCL7C		47)
			●	VKHB 2191	32010 X/Q		
	○ 669-04		●	VKHB 2047	33013/Q		46)
			●	VKHB 2060	32011 X/Q		
	○ 669-04		●	VKHB 2044	33014	VKS 6237	47)
			●	VKHB 2045	33012/Q	VKS 6219	
B 120	●		●	VKHB 2190	33108/Q		67)
			●	VKHB 2057	33205/QVQ077		
	●		●	VKHB 2190	33108/Q		68)
			●	VKHB 2294	32305 J2		

										
		○ 569-01-39				●	VKHB 2060 VKHB 2191	32011 X/Q 32010 X/Q	VKS 6238 VKS 6229	46)
B 70	●	369				●	VKHB 2190 VKHB 2057	33108/Q 33205/QVQ077		17)
	●	369				●	VKHB 2188 VKHB 2189	32008 X/Q 30205 J2/Q		16)
	○	569-39				●	VKHB 2060 VKHB 2191	32011 X/Q 32010 X/Q	VKS 6238 VKS 6229	
B 80	●					●	VKHB 2190 VKHB 2057	33108/Q 33205/QVQ077		67)
	●					●	VKHB 2190 VKHB 2294	33108/Q 32305 J2		68)
	○	569-01-39				●	VKHB 2060 VKHB 2191	32011 X/Q 32010 X/Q	VKS 6238 VKS 6229	46)
B 90	●	369				●	VKHB 2190 VKHB 2057	33108/Q 33205/QVQ077		
	○	569-39				●	VKHB 2060 VKHB 2191	32011 X/Q 32010 X/Q	VKS 6238 VKS 6229	
	○	669-02				●	VKHB 2044 VKHB 2045	33014 33012/Q	VKS 6237 VKS 6219	
C 210	●	E 6A - 4C				●	VKHB 2066 VKHB 2067	33214/Q 33209/Q	VKS 6175	23)
	●	E 6A - 4C				●	VKHB 2066 VKHB 2184	33214/Q T2ED 045	VKS 6175	24)
	○	P 1332				●	VKHB 2186 VKHB 2187	JHM 720249/ JHM 720210 64432/64708	VKS 6201	
C 230/260/280/290 (4x2, 4x4)	●	E 6A - 4C				●	VKHB 2066 VKHB 2184	33214/Q T2ED 045	VKS 6175	24)
	●	E 6A - 711				●	VKHB 2066 VKHB 2184	33214/Q T2ED 045	VKS 6175	
	●	PA 721-B				●			VKS 6234	
	○	P 1332				●	VKHB 2186 VKHB 2187	JHM 720249/ JHM 720210 64432/64708	VKS 6201	
C 300/340 TI (4x2, 4x4)	●	E 6A - 4C				●	VKHB 2066 VKHB 2067	33214/Q 33209/Q	VKS 6175	23)
	●	E 6A - 4C				●	VKHB 2066 VKHB 2184	33214/Q T2ED 045	VKS 6175	24)
	●	E 6A - 711				●	VKHB 2066 VKHB 2184	33214/Q T2ED 045	VKS 6175	
	●	PA 721-B				●			VKS 6234	
	○	P 1332				●	VKHB 2186	JHM 720249/ JHM 720210	VKS 6201	





RENAULT (RVI)

.../...

● VKHB 2187 64432/64708

C 260/280/290 (6x4)

●	E5A-4E	●	VKHB 2051	33213/Q	VKS 6175	52)
		●	VKHB 2067	33209/Q		
●	E5A-4E	●	VKHB 2051	33213/Q	VKS 6175	43)
		●	VKHB 2068	33210/Q		
●	E 6A - 4C	●	VKHB 2066	33214/Q	VKS 6175	23)
		●	VKHB 2067	33209/Q		
●	E 6A - 4C	●	VKHB 2066	33214/Q	VKS 6175	24)
		●	VKHB 2184	T2ED 045		
●	E 6A - 711	●	VKHB 2066	33214/Q	VKS 6175	
		●	VKHB 2184	T2ED 045		
○	PMA/PR 1141-A	●	VKHB 2161	32019 X/Q	VKS 6201	
○	PMA/PR 1321	●	VKHB 2185	52375/52618	VKS 6201	
○	PMA/PR 1341	●	VKHB 2042	683/372		
		●	VKHB 2192	JF 9549/9510	VKS 6201	
		●	VKHB 2194	33216/Q		

C 300/340 TI (6x4)

●	E 5A-4E	●	VKHB 2051	33213/Q	VKS 6175	52)
		●	VKHB 2067	33209/Q		
●	E 5A-4E	●	VKHB 2051	33213/Q	VKS 6175	43)
		●	VKHB 2068	33210/Q		
●	E 6A - 4C	●	VKHB 2066	33214/Q	VKS 6175	23)
		●	VKHB 2067	33209/Q		
●	E 6A - 4C	●	VKHB 2066	33214/Q	VKS 6175	24)
		●	VKHB 2184	T2ED 045		
●	E 6A - 711	●	VKHB 2066	33214/Q	VKS 6175	
		●	VKHB 2184	T2ED 045		
○	PMA/PR 1141-A	●	VKHB 2161	32019 X/Q	VKS 6201	
○	PMA/PR 1321	●	VKHB 2185	52375/52618	VKS 6201	
○	PMA/PR 1341	●	VKHB 2042	683/372		
		●	VKHB 2192	JF 9549/9510	VKS 6201	
		●	VKHB 2194	33216/Q		

CBH 280/340/350/380 (6x4)











●	E 6A	●	VKHB 2066	33214/Q	VKS 6175	
		●	VKHB 2184	T2ED 045		
○	P/PMA 1532	●	VKHB 2186	JHM 720249/ JHM 720210	VKS 6201	
		●	VKHB 2187	64432/64708		

CBH 280/340/350 (6x6)

●	PA 721	●			VKS 6234	
		●	VKHB 2186	JHM 720249/ JHM 720210	VKS 6201	
○	P/PMA 1532	●	VKHB 2187	64432/64708		

CBH 320/385 (6x4)

●	E6B - 811	●	VKHB 2066	33214/Q	VKS 6175	
		●	VKHB 2184	T2ED 045		

									
	○ PMA/P 1532-01				●	VKHB 2186	JHM 720249/ JHM 720210 64432/64708	VKS 6201	
					●	VKHB 2187			
CBH 320/385 (6x6)	● PA 721 - 02				●			VKS 6234	
	○ PMA/P 1532-01				●	VKHB 2186	JHM 720249/ JHM 720210 64432/64708	VKS 6201	
					●	VKHB 2187			
CE 160 Maroc	● E 400-04/14				●	VKHB 2061	33211/Q	VKS 6239	
					●	VKHB 2065	33208/Q		
	● E 408-AA	VKBA 5342			●	VKHB 2066	33214/Q	VKS 6303	
					●	VKHB 2068	33210/Q		
	● E 408-05/13/15/ 24				●	VKHB 2061	33211/Q	VKS 6239	
					●	VKHB 2065	33208/Q		
	○ P 821-13/17				●	VKHB 2169	32017 X/Q		
					●	VKHB 2169	32017 X/Q		
	○ P 1021-03				●			VKS 6234	
	○ P 1040 F				●	VKHB 2161	32019 X/Q	VKS 6201	
					●	VKHB 2158	33117/Q		
	○ P 1041 F				●	VKHB 2161	32019 X/Q	VKS 6201	
	○ P 1140 F				●	VKHB 2161	32019 X/Q	VKS 6201	
					●	VKHB 2158	33117/Q		
	○ P 1141 F				●	VKHB 2161	32019 X/Q	VKS 6201	
					●				
CLM 280/340/350/380	● E 6A - 511				●	VKHB 2066	33214/Q	VKS 6175	
					●	VKHB 2184	T2ED 045		
	○ P 1532-11/12				●	VKHB 2186	JHM 720249/ JHM 720210 64432/64708	VKS 6201	
					●	VKHB 2187			
CLM 320/385 (4x2)	● E6A - 511/811				●	VKHB 2066	33214/Q	VKS 6175	
					●	VKHB 2184	T2ED 045		
	○ P 1532 - 01/11				●	VKHB 2186	JHM 720249/ JHM 720210 64432/64708	VKS 6201	
					●	VKHB 2187			
CLR 220 (4x2)	● E 6A - 711				●	VKHB 2066	33214/Q	VKS 6175	
					●	VKHB 2184	T2ED 045		
	○ P 1332				●	VKHB 2186	JHM 720249/ JHM 720210 64432/64708	VKS 6201	
					●	VKHB 2187			
CLR 220 (4x4)	● PA 721 B				●			VKS 6234	



RENAULT (RVI) .../...

	○ P 1332			● VKHB 2186 ● VKHB 2187	JHM 720249/ JHM 720210 64432/64708	VKS 6201	
CLR 230	● E 5A			● VKHB 2051 ● VKHB 2067	33213/Q 33209/Q	VKS 6175	52)
	● E 5A			● VKHB 2051 ● VKHB 2068	33213/Q 33210/Q	VKS 6175	43)
	● E 6A			● VKHB 2066 ● VKHB 2184	33214/Q T2ED 045	VKS 6175	
	○ P 1332			● VKHB 2186 ● VKHB 2187	JHM 720249/ JHM 720210 64432/64708	VKS 6201	
	○ PR/PMA 1341			● VKHB 2192 ● VKHB 2194	JF 9549/9510 33216/Q	VKS 6201	
	○ PR/PMA 1141 A			● VKHB 2161	32019 X/Q	VKS 6201	
G 170-11/13/15	● E 4A			● VKHB 2173 ● VKHB 2056	33212/Q 33109/Q	VKS 6202	27)
	● E 5A - 921			● VKHB 2051 ● VKHB 2067	33213/Q 33209/Q	VKS 6202	25)
	● E 5A			● VKHB 2051 ● VKHB 2067	33213/Q 33209/Q	VKS 6175	26)
	○ P 1141			● VKHB 2192 ● VKHB 2194	JF 9549/9510 33216/Q	VKS 6201	
G 170-16/17	● E 5A			● VKHB 2051 ● VKHB 2067	33213/Q 33209/Q	VKS 6202	28)
	● E 5A			● VKHB 2051 ● VKHB 2067	33213/Q 33209/Q	VKS 6175	26)
	○ P 1141			● VKHB 2192 ● VKHB 2194	JF 9549/9510 33216/Q	VKS 6201	
G 200	● E 5			● VKHB 2051 ● VKHB 2067	33213/Q 33209/Q	VKS 6175	48)
	● E 5			● VKHB 2051 ● VKHB 2067	33213/Q 33209/Q	VKS 6202	49)
	● E 5			● VKHB 2051 ● VKHB 2067	33213/Q 33209/Q	VKS 6175	50)
	● E 6			● VKHB 2066 ● VKHB 2184	33214/Q T2ED 045	VKS 6175	48)
	● E 6			● VKHB 2066 ● VKHB 2184	33214/Q T2ED 045	VKS 6202	49)
	● E 6			● VKHB 2066 ● VKHB 2184	33214/Q T2ED 045	VKS 6175	51)
	○ P 1140			● VKHB 2192 ● VKHB 2158	JF 9549/9510 33117/Q	VKS 6201	
	○ P 1141, P 1341			● VKHB 2192 ● VKHB 2194	JF 9549/9510 33216/Q	VKS 6201	
	○ P 1332			● VKHB 2186	JHM 720249/ JHM 720210	VKS 6201	



		○ P 1345			● ● ●	VKHB 2187 VKHB 2192	64432/64708 JF 9549/9510	VKS 6201	
G 210	●	E 5A - 4C			● ●	VKHB 2051 VKHB 2067	33213/Q 33209/Q	VKS 6202	28)
	●	E 5A - 4C			●	VKHB 2051 VKHB 2067	33213/Q 33209/Q	VKS 6175	26)
	●	E 5A - 23			●	VKHB 2051 VKHB 2067	33213/Q 33209/Q	VKS 6202	
	●	E 5A - 821			●	VKHB 2051 VKHB 2067	33213/Q 33209/Q	VKS 6202	80)
	●	E 5A - 821			●	VKHB 2051 VKHB 2067	33213/Q 33209/Q	VKS 6175	74)
	●	E 5A - 921			●	VKHB 2051 VKHB 2067	33213/Q 33209/Q	VKS 6202	81)
	●	E 6A - 4D			●	VKHB 2066 VKHB 2067	33214/Q 33209/Q	VKS 6175	23)
	●	E 6A - 4D			●	VKHB 2066 VKHB 2184	33214/Q T2ED 045	VKS 6175	24)
	○	P 1141, P 1341			●	VKHB 2192 VKHB 2194	JF 9549/9510 33216/Q	VKS 6201	
	○	P 1332			●	VKHB 2186 VKHB 2187	JHM 720249/ JHM 720210 64432/64708	VKS 6201	
G 210 Manager	●	E 5			● ●	VKHB 2051 VKHB 2067	33213/Q 33209/Q	VKS 6175	48)
	●	E 5			● ●	VKHB 2051 VKHB 2067	33213/Q 33209/Q	VKS 6202	49)
	●	E 5			● ●	VKHB 2051 VKHB 2067	33213/Q 33209/Q	VKS 6175	50)
	●	E 6			● ●	VKHB 2066 VKHB 2184	33214/Q T2ED 045	VKS 6175	48)
	●	E 6			● ●	VKHB 2066 VKHB 2184	33214/Q T2ED 045	VKS 6202	49)
	●	E 6			● ●	VKHB 2066 VKHB 2184	33214/Q T2ED 045	VKS 6175	51)
	○	P 1140			● ●	VKHB 2192 VKHB 2158	JF 9549/9510 33117/Q	VKS 6201	
	○	P 1141, P 1341			● ●	VKHB 2192 VKHB 2194	JF 9549/9510 33216/Q	VKS 6201	
	○	P 1332			●	VKHB 2186 VKHB 2187	JHM 720249/ JHM 720210 64432/64708	VKS 6201	
	○	P 1345			● ●	VKHB 2192	JF 9549/9510	VKS 6201	
G 220 BOM	●	E 5A - 23			● ●	VKHB 2051 VKHB 2067	33213/Q 33209/Q	VKS 6202	53)
	●	E 5A - 23			● ●	VKHB 2051 VKHB 2067	33213/Q 33209/Q	VKS 6175	50)
	●	E 5A - 23			●	VKHB 2051	33213/Q	VKS 6175	43)















RENAULT (RVI)

.../...

	●	E 5B - 4C		●	VKHB 2068	33210/Q		
	●	E 5B - 4C		●	VKHB 2051	33213/Q	VKS 6175	48)
	●	E 5B - 4C		●	VKHB 2067	33209/Q		
	●	E 5B - 4C		●	VKHB 2051	33213/Q	VKS 6202	49)
	●	E 5B - 4C		●	VKHB 2067	33209/Q		
	●	E 5B - 4C		●	VKHB 2051	33213/Q	VKS 6175	50)
	●	E 5B - 4C		●	VKHB 2067	33209/Q		
	●	E 6B - 4D		●	VKHB 2051	33213/Q	VKS 6175	43)
	●	E 6B - 4D		●	VKHB 2068	33210/Q		
	●	E 6B - 4D		●	VKHB 2066	33214/Q	VKS 6175	48)
	●	E 6B - 4D		●	VKHB 2184	T2ED 045		
	●	E 6B - 4D		●	VKHB 2066	33214/Q	VKS 6202	49)
	●	E 6B - 4D		●	VKHB 2184	T2ED 045		
	○	P 1332		●	VKHB 2066	33214/Q	VKS 6175	51)
	○	P 1341 C		●	VKHB 2184	T2ED 045		
	○	P 1345		●	VKHB 2186	JHM 720249/ JHM 720210	VKS 6201	
				●	VKHB 2187	64432/64708		
				●	VKHB 2192	JF 9549/9510	VKS 6201	
				●	VKHB 2194	33216/Q		
				●	VKHB 2192	JF 9549/9510	VKS 6201	
				●				
G 230	●	E 5A - 4C		●	VKHB 2051	33213/Q	VKS 6202	28)
	●	E 5A - 4C		●	VKHB 2067	33209/Q		
	●	E 5A - 23		●	VKHB 2051	33213/Q	VKS 6175	26)
	●	E 5A - 821		●	VKHB 2067	33209/Q		
	●	E 5A - 821		●	VKHB 2051	33213/Q	VKS 6202	
	●	E 5A - 821		●	VKHB 2067	33209/Q		
	●	E 5A - 821		●	VKHB 2051	33213/Q	VKS 6202	80)
	●	E 5A - 821		●	VKHB 2067	33209/Q		
	●	E 5A - 921		●	VKHB 2051	33213/Q	VKS 6175	74)
	●	E 5A - 921		●	VKHB 2067	33209/Q		
	●	E 5A - 921		●	VKHB 2051	33213/Q	VKS 6202	81)
	●	E 5A - 921		●	VKHB 2067	33209/Q		
	●	E 6A - 4D		●	VKHB 2066	33214/Q	VKS 6175	23)
	●	E 6A - 4D		●	VKHB 2067	33209/Q		
	●	E 6A - 4D		●	VKHB 2066	33214/Q	VKS 6175	24)
	●	E 6A - 4D		●	VKHB 2184	T2ED 045		
	○	P 1141, P 1341		●	VKHB 2192	JF 9549/9510	VKS 6201	
	○	P 1332		●	VKHB 2194	33216/Q		
				●	VKHB 2186	JHM 720249/ JHM 720210	VKS 6201	
				●	VKHB 2187	64432/64708		
G 230 Incendie	●	E 5A - 921		●	VKHB 2051	33213/Q	VKS 6202	
	●	E 5A - 4C		●	VKHB 2067	33209/Q		
	●	E 5A - 4C		●	VKHB 2051	33213/Q	VKS 6175	52)
	●	E 5A - 4C		●	VKHB 2067	33209/Q		
	●	E 5A - 4C		●	VKHB 2051	33213/Q	VKS 6175	43)
	●	E 5A - 4C		●	VKHB 2068	33210/Q		
	○	P 1141		●	VKHB 2192	JF 9549/9510	VKS 6201	











										
						●	VKHB 2194	33216/Q		
G 230 TI	●	E 5				●	VKHB 2051 VKHB 2067	33213/Q 33209/Q	VKS 6175	48)
	●	E 5				●	VKHB 2051 VKHB 2067	33213/Q 33209/Q	VKS 6202	49)
	●	E 5				●	VKHB 2051 VKHB 2067	33213/Q 33209/Q	VKS 6175	50)
	●	E 6				●	VKHB 2066 VKHB 2184	33214/Q T2ED 045	VKS 6175	48)
	●	E 6				●	VKHB 2066 VKHB 2184	33214/Q T2ED 045	VKS 6202	49)
	●	E 6				●	VKHB 2066 VKHB 2184	33214/Q T2ED 045	VKS 6175	51)
	○	P 1140				●	VKHB 2192 VKHB 2158	JF 9549/9510 33117/Q	VKS 6201	
	○	P 1141, P 1341				●	VKHB 2192 VKHB 2194	JF 9549/9510 33216/Q	VKS 6201	
	○	P 1332				●	VKHB 2186	JHM 720249/ JHM 720210	VKS 6201	
	○	P 1345				●	VKHB 2187	64432/64708	VKS 6201	
						●	VKHB 2192	JF 9549/9510	VKS 6201	
G 235 Maxter 4x2	●		VKBA 5308			●				
	○	P 1541 A				●	VKHB 2192 VKHB 2194	JF 9549/9510 33216/Q	VKS 6201	
	○	P 1545 A				●	VKHB 2192	JF 9549/9510	VKS 6201	
G 260 11/13 T	●	E 4A				●	VKHB 2173 VKHB 2056	33212/Q 33109/Q	VKS 6202	27)
	●	E 5A				●	VKHB 2051 VKHB 2067	33213/Q 33209/Q	VKS 6202	29)
	○	P 1141				●	VKHB 2192 VKHB 2194	JF 9549/9510 33216/Q	VKS 6201	
G 260 15 T	●	E 4A				●	VKHB 2173 VKHB 2056	33212/Q 33109/Q	VKS 6202	30)
	●	E 5A				●	VKHB 2051 VKHB 2067	33213/Q 33209/Q	VKS 6202	31)
	○	P 1141				●	VKHB 2192 VKHB 2194	JF 9549/9510 33216/Q	VKS 6201	
G 260 16/17 T	●	E 5A				●	VKHB 2051 VKHB 2067	33213/Q 33209/Q	VKS 6202	28)
	●	E 5A - 4C				●	VKHB 2051 VKHB 2067	33213/Q 33209/Q	VKS 6175	26)
	○	P 1141				●	VKHB 2192 VKHB 2194	JF 9549/9510 33216/Q	VKS 6201	





RENAULT (RVI) .../...











G 260 19 T	●	E 5A	●	VKHB 2051	33213/Q	VKS 6202	
			●	VKHB 2067	33209/Q		
	●	E 5A - 821	●	VKHB 2051	33213/Q	VKS 6175	74)
			●	VKHB 2067	33209/Q		
	●	E 6A	●	VKHB 2066	33214/Q	VKS 6175	23)
			●	VKHB 2067	33209/Q		
	●	E 6A	●	VKHB 2066	33214/Q	VKS 6175	24)
		●	VKHB 2184	T2ED 045			
	○	P 1332	●	VKHB 2186	JHM 720249/ JHM 720210	VKS 6201	
			●	VKHB 2187	64432/64708		
	○	P 1341, PR 1341	●	VKHB 2192	JF 9549/9510	VKS 6201	
			●	VKHB 2194	33216/Q		
G 260 22 T	●	E 5A	●	VKHB 2051	33213/Q	VKS 6202	28)
			●	VKHB 2067	33209/Q		
	○	P 1141	●	VKHB 2192	JF 9549/9510	VKS 6201	
			●	VKHB 2194	33216/Q		
G 260 26 T	●	E 6A	●	VKHB 2066	33214/Q	VKS 6175	23)
			●	VKHB 2067	33209/Q		
	●	E 6A	●	VKHB 2066	33214/Q	VKS 6175	24)
			●	VKHB 2184	T2ED 045		
	●	E 5A - 23	●	VKHB 2051	33213/Q	VKS 6202	
			●	VKHB 2067	33209/Q		
	○	P/PR 1341	●	VKHB 2192	JF 9549/9510	VKS 6201	
			●	VKHB 2194	33216/Q		
G 270 BOM	●	E 5A - 23	●	VKHB 2051	33213/Q	VKS 6202	53)
			●	VKHB 2067	33209/Q		
	●	E 5A - 23	●	VKHB 2051	33213/Q	VKS 6175	50)
			●	VKHB 2067	33209/Q		
	●	E 5A - 23	●	VKHB 2051	33213/Q	VKS 6175	43)
			●	VKHB 2068	33210/Q		
	●	E 5B - 4C	●	VKHB 2051	33213/Q	VKS 6175	48)
			●	VKHB 2067	33209/Q		
	●	E 5B - 4C	●	VKHB 2051	33213/Q	VKS 6202	49)
			●	VKHB 2067	33209/Q		
	●	E 5B - 4C	●	VKHB 2051	33213/Q	VKS 6175	50)
			●	VKHB 2067	33209/Q		
	●	E 5B - 4C	●	VKHB 2051	33213/Q	VKS 6175	43)
			●	VKHB 2068	33210/Q		
	●	E 6B - 4D	●	VKHB 2066	33214/Q	VKS 6175	48)
		●	VKHB 2184	T2ED 045			
●	E 6B - 4D	●	VKHB 2066	33214/Q	VKS 6202	49)	
		●	VKHB 2184	T2ED 045			
●	E 6B - 4D	●	VKHB 2066	33214/Q	VKS 6175	51)	
		●	VKHB 2184	T2ED 045			
	○	P 1332	●	VKHB 2186	JHM 720249/ JHM 720210	VKS 6201	
			●	VKHB 2187	64432/64708		

																				
	<ul style="list-style-type: none"> ○ P 1341 C ○ P 1345 				<ul style="list-style-type: none"> ● VKHB 2192 ● VKHB 2194 ● VKHB 2192 	<ul style="list-style-type: none"> JF 9549/9510 33216/Q JF 9549/9510 	VKS 6201		VKS 6201											
G 270 Incendie	<ul style="list-style-type: none"> ● E 5A - 921 ● E 5A - 4C ● E 5A - 4C ○ P 1141 				<ul style="list-style-type: none"> ● VKHB 2051 ● VKHB 2067 ● VKHB 2051 ● VKHB 2067 ● VKHB 2051 ● VKHB 2068 ● VKHB 2192 ● VKHB 2194 	<ul style="list-style-type: none"> 33213/Q 33209/Q 33213/Q 33209/Q 33213/Q 33210/Q JF 9549/9510 33216/Q 	VKS 6202	VKS 6175 52)	VKS 6175 43)	VKS 6201										
G 270 Maxter 4x2	<ul style="list-style-type: none"> ● P 1541 A ○ P 1545 A 	VKBA 5308			<ul style="list-style-type: none"> ● VKHB 2192 ● VKHB 2194 ● VKHB 2192 	<ul style="list-style-type: none"> JF 9549/9510 33216/Q JF 9549/9510 	VKS 6201		VKS 6201											
G 270/280 Manager 4x2, 6x2/4	<ul style="list-style-type: none"> ● E 5A - 23 ● E 5A - 23 ● E 5A - 23 ● E 5A - 4C, E 5B - 4C, E 5A - 821 ● E 5A - 4C, E 5B - 4C, E 5A - 821 ● E 5A - 4C, E 5B - 4C, E 5A - 821 ● E 5A - 4C, E 5B - 4C, E 5A - 821 ● E 5A - 4C, E 5B - 4C, E 5A - 821 ● E 6A - 4D, E 6B - 4D ● E 6A, E 6B ● E 6A, E 6B ● E 6A, E 6B ○ P 1141, P 1341 ○ P 1142, P 1345 				<ul style="list-style-type: none"> ● VKHB 2051 ● VKHB 2067 ● VKHB 2051 ● VKHB 2067 ● VKHB 2051 ● VKHB 2068 ● VKHB 2051 ● VKHB 2067 ● VKHB 2051 ● VKHB 2067 ● VKHB 2051 ● VKHB 2068 ● VKHB 2066 ● VKHB 2184 ● VKHB 2066 ● VKHB 2184 ● VKHB 2066 ● VKHB 2184 ● VKHB 2066 ● VKHB 2184 ● VKHB 2192 ● VKHB 2194 ● VKHB 2192 	<ul style="list-style-type: none"> 33213/Q 33209/Q 33213/Q 33209/Q 33213/Q 33210/Q 33213/Q 33209/Q 33213/Q 33209/Q 33213/Q 33210/Q 33214/Q T2ED 045 33214/Q T2ED 045 33214/Q T2ED 045 33214/Q T2ED 045 JF 9549/9510 33216/Q JF 9549/9510 	VKS 6202 53)	VKS 6175 50)	VKS 6175 43)	VKS 6175 48)	VKS 6202 49)	VKS 6175 50)	VKS 6175 50)	VKS 6175 43)	VKS 6175	VKS 6175 48)	VKS 6202 49)	VKS 6175 51)	VKS 6201 53)	VKS 6201



RENAULT (RVI) .../...











	○ P 1332			● VKHB 2186 ● VKHB 2187	JHM 720249/ JHM 720210 64432/64708	VKS 6201	
G 270/280 Manager 4x4	● ○ P 1141, P 1341 ○ P 1142, P 1345 ○ P 1332			● ● ● VKHB 2192 ● VKHB 2194 ● VKHB 2192 ● ● VKHB 2186 ● VKHB 2187	JF 9549/9510 33216/Q JF 9549/9510 JHM 720249/ JHM 720210 64432/64708	VKS 6234 VKS 6201 VKS 6201 VKS 6201	53)
G 270/280 Manager 6x2, 6x4, 8x4	● E 5A - 821 ● E 5A - 821 ● E 5A - 821 ● E 5A - 821 ● E 5A - 821 ● E 5A - 821 ● E 6A, E 6B ● E 6A, E 6B ● E 6A, E 6B ● E 6A - 4D, E 6B - 4D ○ PR 1141 A, PMA 1141 A ○ P 1332 ○ PMA 1341 ○ P 1345			● VKHB 2051 ● VKHB 2067 ● VKHB 2051 ● VKHB 2067 ● VKHB 2051 ● VKHB 2067 ● VKHB 2051 ● VKHB 2067 ● VKHB 2051 ● VKHB 2067 ● VKHB 2066 ● VKHB 2067 ● VKHB 2066 ● VKHB 2184 ● VKHB 2066 ● VKHB 2184 ● VKHB 2066 ● VKHB 2184 ● VKHB 2066 ● VKHB 2184 ● VKHB 2161 ● VKHB 2186 ● VKHB 2187 ● VKHB 2192 ● VKHB 2194 ● VKHB 2192	33213/Q 33209/Q 33213/Q 33209/Q 33213/Q 33209/Q 33214/Q 33209/Q 33214/Q T2ED 045 33214/Q T2ED 045 33214/Q T2ED 045 33214/Q T2ED 045 33214/Q T2ED 045 32019 X/Q JHM 720249/ JHM 720210 64432/64708 JF 9549/9510 33216/Q JF 9549/9510	VKS 6175 VKS 6202 VKS 6175 VKS 6202 VKS 6175 VKS 6175 VKS 6175 VKS 6202 VKS 6175 VKS 6202 VKS 6175 VKS 6175 VKS 6201 VKS 6201 VKS 6201 VKS 6201	75) 76) 79) 77) 78) 43) 48) 49) 51)
G 290 (VTL) 6x4	● E 6A ● E 6A ○ 1341			● VKHB 2066 ● VKHB 2184 ● VKHB 2066 ● VKHB 2184 ● VKHB 2192	33214/Q T2ED 045 33214/Q T2ED 045 JF 9549/9510	VKS 6175 VKS 6202 VKS 6201	70)

									
					●	VKHB 2194	33216/Q		
G 290 16/17 T	●	E 5A			●	VKHB 2051 VKHB 2067	33213/Q 33209/Q	VKS 6202	28)
	●	E 5A - 4C			●	VKHB 2051 VKHB 2067	33213/Q 33209/Q	VKS 6175	26)
	○	P 1141			●	VKHB 2192 VKHB 2194	JF 9549/9510 33216/Q	VKS 6201	
G 290 19 T	●	E 5A - 23			●	VKHB 2051 VKHB 2067	33213/Q 33209/Q	VKS 6202	28)
	●	E 6A			●	VKHB 2066 VKHB 2067	33214/Q 33209/Q	VKS 6175	23)
	●	E 6A			●	VKHB 2066 VKHB 2184	33214/Q T2ED 045	VKS 6175	24)
	○	P 1332			●	VKHB 2186	JHM 720249/ JHM 720210	VKS 6201	
	○	P 1341, PR 1341			●	VKHB 2187	64432/64708	VKS 6201	
	●	E 6A - 4D			●	VKHB 2066 VKHB 2184	33214/Q T2ED 045	VKS 6175	
G 290 VTL	○	PR/PMA 1341			●	VKHB 2192 VKHB 2194	JF 9549/9510 33216/Q	VKS 6201	
G 300 Maxter 4x2	●		VKBA 5308		●				
	○	P 1541 A			●	VKHB 2192 VKHB 2194	JF 9549/9510 33216/Q	VKS 6201	
	○	P 1545 A			●	VKHB 2192	JF 9549/9510	VKS 6201	
G 300 Maxter 6x4, 8x4	●	ESS - 83	VKBA 5308		●				47)
	○	PMA/PR 1141 A			●	VKHB 2161	32019 X/Q	VKS 6201	
	○	PMA/PR 1841 B			●	VKHB 2192 VKHB 2194	JF 9549/9510 33216/Q	VKS 6201	
	○	PMA/PR 1845 B			●	VKHB 2192	JF 9549/9510	VKS 6201	
G 300/330/340 TI Manager 4x2, 6x2/4	●	E 5A - 23			●	VKHB 2051 VKHB 2067	33213/Q 33209/Q	VKS 6202	53)
	●	E 5A - 23			●	VKHB 2051 VKHB 2067	33213/Q 33209/Q	VKS 6175	50)
	●	E 5A - 23			●	VKHB 2051 VKHB 2068	33213/Q 33210/Q	VKS 6175	43)
	●	E 5A - 4C, E 5B - 4C, E 5A - 821			●	VKHB 2051 VKHB 2067	33213/Q 33209/Q	VKS 6175	48)



RENAULT (RVI) .../...

	<ul style="list-style-type: none"> ● E 5A - 4C, E 5B - 4C, E 5A - 821 ● E 5A - 4C, E 5B - 4C, E 5A - 821 ● E 5A - 4C, E 5B - 4C, E 5A - 821 ● E 6A - 4D, E 6B - 4D ● E 6A, E 6B ● E 6A, E 6B ● E 6A, E 6B ○ P 1141, P 1341 ○ P 1142, P 1345 ○ P 1332 			<ul style="list-style-type: none"> ● VKHB 2051 33213/Q VKHB 2067 33209/Q ● VKHB 2051 33213/Q VKHB 2067 33209/Q ● VKHB 2051 33213/Q VKHB 2068 33210/Q ● VKHB 2066 33214/Q VKHB 2184 T2ED 045 ● VKHB 2066 33214/Q VKHB 2184 T2ED 045 ● VKHB 2066 33214/Q VKHB 2184 T2ED 045 ● VKHB 2066 33214/Q VKHB 2184 T2ED 045 ● VKHB 2192 JF 9549/9510 VKHB 2194 33216/Q ● VKHB 2192 JF 9549/9510 ● VKHB 2186 JHM 720249/ JHM 720210 VKHB 2187 64432/64708 	<ul style="list-style-type: none"> VKS 6202 49) VKS 6175 50) VKS 6175 43) VKS 6175 VKS 6175 48) VKS 6202 49) VKS 6175 51) VKS 6201 53) VKS 6201 VKS 6201
G 300/330/340 TI Manager 4x4	<ul style="list-style-type: none"> ○ P 1141, P 1341 ○ P 1142, P 1345 ○ P 1332 		<ul style="list-style-type: none"> ● VKHB 2192 JF 9549/9510 VKHB 2194 33216/Q ● VKHB 2192 JF 9549/9510 ● VKHB 2186 JHM 720249/ JHM 720210 VKHB 2187 64432/64708 	<ul style="list-style-type: none"> VKS 6234 VKS 6201 53) VKS 6201 VKS 6201 	
G 300/330/340 TI Manager 6x2, 6x4, 8x4	<ul style="list-style-type: none"> ● E 5A - 821 ● E 5A - 821 ● E 5A - 821 ● E 5A - 821 ● E 5A - 821 ● E 5A - 821 ● E 5A - 821 ● E 6A, E 6B 		<ul style="list-style-type: none"> ● VKHB 2051 33213/Q VKHB 2067 33209/Q ● VKHB 2051 33213/Q VKHB 2067 33209/Q ● VKHB 2051 33213/Q VKHB 2067 33209/Q ● VKHB 2051 33213/Q VKHB 2067 33209/Q ● VKHB 2051 33213/Q VKHB 2067 33209/Q ● VKHB 2051 33213/Q VKHB 2067 33209/Q ● VKHB 2051 33213/Q VKHB 2068 33210/Q ● VKHB 2066 33214/Q VKHB 2184 T2ED 045 	<ul style="list-style-type: none"> VKS 6175 75) VKS 6202 76) VKS 6175 79) VKS 6202 77) VKS 6175 78) VKS 6175 43) VKS 6175 48) 	

									
	<ul style="list-style-type: none"> ● E 6A, E 6B ● E 6A, E 6B ● E 6A - 4D ○ PMA/PR 1141 A ○ P 1332 ○ PMA 1341 ○ P 1345 				<ul style="list-style-type: none"> ● VKHB 2066 33214/Q ● VKHB 2184 T2ED 045 ● VKHB 2066 33214/Q ● VKHB 2184 T2ED 045 ● VKHB 2066 33214/Q ● VKHB 2184 T2ED 045 ● VKHB 2161 32019 X/Q ● VKHB 2186 JHM 720249/ JHM 720210 ● VKHB 2187 64432/64708 ● VKHB 2192 JF 9549/9510 ● VKHB 2194 33216/Q ● VKHB 2192 JF 9549/9510 	<ul style="list-style-type: none"> VKS 6202 49) VKS 6175 51) VKS 6175 VKS 6201 VKS 6201 VKS 6201 VKS 6201 			
G 320-19 (VF6-BA)	<ul style="list-style-type: none"> ● E 6A - 4D ○ P 1332 				<ul style="list-style-type: none"> ● VKHB 2066 33214/Q ● VKHB 2184 T2ED 045 ● VKHB 2186 JHM 720249/ JHM 720210 ● VKHB 2187 64432/64708 	<ul style="list-style-type: none"> VKS 6175 VKS 6201 			
G 320-19 T (VF6-BG)	<ul style="list-style-type: none"> ● E 5A - 821 ○ P 1332 				<ul style="list-style-type: none"> ● VKHB 2051 33213/Q ● VKHB 2067 33209/Q ● VKHB 2186 JHM 720249/ JHM 720210 ● VKHB 2187 64432/64708 	<ul style="list-style-type: none"> VKS 6175 VKS 6201 			
G 340 TI 4x4 (VF6-BH02)	<ul style="list-style-type: none"> ● ○ 				<ul style="list-style-type: none"> ● ● VKHB 2186 JHM 720249/ JHM 720210 ● VKHB 2187 64432/64708 	<ul style="list-style-type: none"> VKS 6234 VKS 6201 			
G 340 TI Maxter 4x2	<ul style="list-style-type: none"> ● ○ P 1541 A ○ P 1545 A 		VKBA 5308		<ul style="list-style-type: none"> ● ● VKHB 2192 JF 9549/9510 ● VKHB 2194 33216/Q ● VKHB 2192 JF 9549/9510 	<ul style="list-style-type: none"> VKS 6201 VKS 6201 			
G 340 TI Maxter 6x4, 8x4	<ul style="list-style-type: none"> ● ESS - 83 ○ PMA/PR 1141 A ○ PMA/PR 1841 B ○ PMA/PR 1845 B 		VKBA 5308		<ul style="list-style-type: none"> ● ● VKHB 2161 32019 X/Q ● VKHB 2192 JF 9549/9510 ● VKHB 2194 33216/Q ● VKHB 2192 JF 9549/9510 	<ul style="list-style-type: none"> 47) VKS 6201 VKS 6201 VKS 6201 			
G 340 TI Maxter 6x6	<ul style="list-style-type: none"> ● ○ 				<ul style="list-style-type: none"> ● VKHB 2192 JF 9549/9510 ● VKHB 2192 JF 9549/9510 	<ul style="list-style-type: none"> VKS 6201 VKS 6201 			















RENAULT (RVI)

.../...

GB 131-HR15	●	E4A			●	VKHB 2173 VKHB 2056	33212/Q 33109/Q	VKS 6202	
		○ P 920-B1/F/G/H			●			VKS 6234	
		○ P 921-B1/G/H/J			●			VKS 6234	
GB 191	●	E4A			●	VKHB 2173 VKHB 2056	33212/Q 33109/Q	VKS 6202	
		○ P 921 - B1/G			●			VKS 6234	
GB 231	●	E4A			●	VKHB 2173 VKHB 2056	33212/Q 33109/Q	VKS 6202	
		○ P 921 - B1/G			●			VKS 6234	
GBC 180	●				●	VKHB 2041	580/572/Q		
		○ Forward rear			●	VKHB 2080 VKHB 2026	32217 J2/Q 32216 J2/Q		
		○ Rear rear			●	VKHB 2080 VKHB 2026	32217 J2/Q 32216 J2/Q		
GBH 260 (6x6)	●	PKBS 3			●	VKHB 2170 VKHB 2169	32018 X/Q 32017 X/Q		
		○ PMA/PR 1032			●	VKHB 2186	JHM 720249/ JHM 720210	VKS 6201	
					●	VKHB 2187	64432/64708		
GBH 260 (6x4)	●	E 6A			●	VKHB 2066 VKHB 2067	33214/Q 33209/Q	VKS 6175	73)
		○ PMA/PR 1032			●	VKHB 2186	JHM 720249/ JHM 720210	VKS 6201	
					●	VKHB 2187	64432/64708		
GBH 280 E (6x6)	●	PA 721			●			VKS 6234	
		○ PMA/P 1532			●	VKHB 2186	JHM 720249/ JHM 720210	VKS 6201	
					●	VKHB 2187	64432/64708		
GBH 280 (6x4 D)	●	E 6A			●	VKHB 2066 VKHB 2067	33214/Q 33209/Q	VKS 6175	73)
	●	E 6A - 511			●	VKHB 2066 VKHB 2184	33214/Q T2ED 045	VKS 6175	24)
		○ PMA/PR 1032			●	VKHB 2186	JHM 720249/ JHM 720210	VKS 6201	











									
					●	VKHB 2187	64432/64708		
GBH 280 (6x4)	●	E 6A			●	VKHB 2066	33214/Q	VKS 6175	73)
	●	E 6A			●	VKHB 2067	33209/Q	VKS 6175	24)
	○	PMA/PR 1532			●	VKHB 2066	33214/Q	VKS 6175	
					●	VKHB 2184	T2ED 045	VKS 6201	
					●	VKHB 2186	JHM 720249/ JHM 720210	VKS 6201	
					●	VKHB 2187	64432/64708		
GBH 280 (6x6)	●	PKBS 3			●	VKHB 2170	32018 X/Q	VKS 6201	
	○	PMA/PR 1032			●	VKHB 2169	32017 X/Q	VKS 6201	
					●	VKHB 2186	JHM 720249/ JHM 720210	VKS 6201	
					●	VKHB 2187	64432/64708		
GC 191	●	E 5A			●	VKHB 2051	33213/Q	VKS 6202	
	○	P 1021			●	VKHB 2067	33209/Q	VKS 6201	
					●	VKHB 2185	52375/52618	VKS 6201	
					●	VKHB 2042	683/372		
GC 231	●	E 5A			●	VKHB 2051	33213/Q	VKS 6202	
	○	P 1021			●	VKHB 2067	33209/Q	VKS 6201	
					●	VKHB 2185	52375/52618	VKS 6201	
					●	VKHB 2042	683/372		
GF 191	●	E 5A			●	VKHB 2051	33213/Q	VKS 6202	
	○	P 1021			●	VKHB 2067	33209/Q	VKS 6201	
					●	VKHB 2185	52375/52618	VKS 6201	
					●	VKHB 2042	683/372		
GF 231	●	E 5A			●	VKHB 2051	33213/Q	VKS 6202	
	○	P 1021			●	VKHB 2067	33209/Q	VKS 6201	
					●	VKHB 2185	52375/52618	VKS 6201	
					●	VKHB 2042	683/372		
GLC 190	●	E 5A			●	VKHB 2051	33213/Q	VKS 6202	
	○	P 1021			●	VKHB 2067	33209/Q	VKS 6201	33)
	○	P 1321			●	VKHB 2185	52375/52618	VKS 6201	34)
					●	VKHB 2042	683/372		
					●	VKHB 2185	52375/52618	VKS 6201	
					●	VKHB 2042	683/372		
GLM 280	●	E 6A - 51			●	VKHB 2066	33214/Q	VKS 6175	23)
	●	E 6A - 51			●	VKHB 2067	33209/Q	VKS 6175	24)
	○	P 1532			●	VKHB 2066	33214/Q	VKS 6175	
					●	VKHB 2184	T2ED 045	VKS 6201	
					●	VKHB 2186	JHM 720249/ JHM 720210	VKS 6201	
					●	VKHB 2187	64432/64708		





RENAULT (RVI)	.../...
---------------	---------

GLR 190/230	●	E 6A	●	VKHB 2066	33214/Q	VKS 6175	23)
			●	VKHB 2067	33209/Q		
	●	E 6A	●	VKHB 2066	33214/Q	VKS 6175	24)
			●	VKHB 2184	T2ED 045		
	○	P 1332	●	VKHB 2186	JHM 720249/ JHM 720210	VKS 6201	
			●	VKHB 2187	64432/64708		
GLR 230 (4x4)	●	PA 721	●			VKS 6234	
			●				
	○	PMA/P 1332	●	VKHB 2186	JHM 720249/ JHM 720210	VKS 6201	
			●	VKHB 2187	64432/64708		
GR 191	●	E 6A	●	VKHB 2066	33214/Q	VKS 6175	23)
			●	VKHB 2067	33209/Q		
	●	E 6A	●	VKHB 2066	33214/Q	VKS 6175	24)
			●	VKHB 2184	T2ED 045		
	○	P 1321	●	VKHB 2185	52375/52618	VKS 6201	
			●	VKHB 2042	683/372		
	○	P 1332	●	VKHB 2186	JHM 720249/ JHM 720210	VKS 6201	
			●	VKHB 2187	64432/64708		
GR 231	●	E 6A	●	VKHB 2066	33214/Q	VKS 6175	23)
			●	VKHB 2067	33209/Q		
	●	E 6A	●	VKHB 2066	33214/Q	VKS 6175	24)
			●	VKHB 2184	T2ED 045		
	○	P 1321	●	VKHB 2185	52375/52618	VKS 6201	
			●	VKHB 2042	683/372		
	○	P 1332	●	VKHB 2186	JHM 720249/ JHM 720210	VKS 6201	
			●	VKHB 2187	64432/64708		
GR 280/350	●	E 6A	●	VKHB 2066	33214/Q	VKS 6175	
			●	VKHB 2067	33209/Q		
	○	P 1332	●	VKHB 2186	JHM 720249/ JHM 720210	VKS 6201	
			●	VKHB 2187	64432/64708		
GR 305	●	E 6A	●	VKHB 2066	33214/Q	VKS 6175	
			●	VKHB 2067	33209/Q		
	○	P 1332, P1332 B	●	VKHB 2186	JHM 720249/ JHM 720210	VKS 6201	
			●	VKHB 2187	64432/64708		
GRH 235	●	E 6A	●	VKHB 2066	33214/Q	VKS 6175	
			●	VKHB 2067	33209/Q		
	○	PMA/P 1021	●	VKHB 2185	52375/52618	VKS 6201	

									
					●	VKHB 2042	683/372		
GRH 235 R	●	E 6A			●	VKHB 2066 VKHB 2067	33214/Q 33209/Q	VKS 6175	23)
	○	PMA/P 1321			●	VKHB 2185 VKHB 2042	52375/52618 683/372	VKS 6201	
GRH 305 (6x4)	●	E 6A - 21			●	VKHB 2066 VKHB 2067	33214/Q 33209/Q	VKS 6175	
	○	PMA 1021, PMA 1321			●	VKHB 2185 VKHB 2042	52375/52618 683/372	VKS 6201	
	○	PMA 1032 B, PMA 1532			●	VKHB 2186	JHM 720249/ JHM 720210	VKS 6201	
	●				●	VKHB 2187	64432/64708	VKS 6201	
GRH 350 6x4 GRH 350 TS	●	E 6A			●	VKHB 2066 VKHB 2067	33214/Q 33209/Q	VKS 6175	
	○	PMA/PR 1032 B, PMA/P 1532			●	VKHB 2186	JHM 720249/ JHM 720210	VKS 6201	
	○	PMA/PR/ P 1021 PMA/ PR 1321			●	VKHB 2187	64432/64708	VKS 6201	
JK 50/55/60/65/75	●	402			●	VKHB 2067 VKHB 2016	33209/Q 32206 J2/Q		12)
	●	402			●	VKHB 2067 VKHB 2179	33209/Q 33206/Q		13)
	○	669			●	VKHB 2044 VKHB 2045	33014 33012/Q	VKS 6237 VKS 6219	
	○	70 HD			●	VKHB 2044 VKHB 2045	33014 33012/Q	VKS 6237	
JN 60/75/85/90/95	●	E 401			●	VKHB 2017 VKHB 2018	32210 J2/Q 32207 J2/Q	VKS 6235	
	○	SOMA 95			●	VKHB 2046 VKHB 2047	33015/Q 33013/Q	VKS 6237 VKS 6236	
JP 11	●	400			●	VKHB 2019 VKHB 2020	32211 J2/Q 32208 J2/Q	VKS 6239	
	○	P 620 F			●	VKHB 2048 VKHB 2046	33018/Q 33015/Q	VKS 6233	14)
	○	P 620 F1			●	VKHB 2048 VKHB 2046	33018/Q 33015/Q	VKS 6234	15)
	○	15 M			●	VKHB 2048 VKHB 2046	33018/Q 33015/Q	VKS 6233	





RENAULT (RVI) .../...

JP 13 A/B/C	●	400		●	VKHB 2019 VKHB 2020	32211 J2/Q 32208 J2/Q	VKS 6239	
	○	P 820 F		●	VKHB 2048 VKHB 2046	33018/Q 33015/Q	VKS 6233	14)
	○	P 820 F1		●	VKHB 2048 VKHB 2046	33018/Q 33015/Q	VKS 6234	15)
	○	15 M/MHD, 17 M		●	VKHB 2048 VKHB 2046	33018/Q 33015/Q	VKS 6233	
JP 14 BOM	●	400		●	VKHB 2019 VKHB 2020	32211 J2/Q 32208 J2/Q	VKS 6239	
	○	P 820 F		●	VKHB 2048 VKHB 2046	33018/Q 33015/Q	VKS 6233	14)
	○	P 820 F1		●	VKHB 2048 VKHB 2046	33018/Q 33015/Q	VKS 6234	15)
	○	15 M/MHD, 17 M		●	VKHB 2048 VKHB 2046	33018/Q 33015/Q	VKS 6233	
JR 19/21	●	400		●	VKHB 2019 VKHB 2020	32211 J2/Q 32208 J2/Q	VKS 6239	
	○	P 17 M		●	VKHB 2048 VKHB 2046	33018/Q 33015/Q	VKS 6233	
	○	P 821 F		●			VKS 6233	14)
	○	P 821 F1		●			VKS 6234	15)
JX 21	●	400		●	VKHB 2019 VKHB 2020	32211 J2/Q 32208 J2/Q	VKS 6239	
	○	P 17 M		●	VKHB 2048 VKHB 2046	33018/Q 33015/Q	VKS 6233	
	○	P 821 F		●			VKS 6233	14)
	○	P 821 F1		●			VKS 6234	15)
KERAX	●	-	VKBA 5308	●				105)
	●	PA 941		●	VKHB 2192 VKHB 2194	JF 9549/9510 33216/Q	VKS 6201	
	●	PA 945		●	VKHB 2192 VKHB 2337	JF 9549/9510 JT 9049/9010	VKS 6201	
	○	Trailing axle	VKBA 5308	●				106)
	○	P 1841		●	VKHB 2192 VKHB 2194	JF 9549/9510 33216/Q	VKS 6201	
	○	P 1541		●	VKHB 2192 VKHB 2194	JF 9549/9510 33216/Q	VKS 6201	
	○	P 1545		●	VKHB 2192 VKHB 2337	JF 9549/9510 JT 9049/9010	VKS 6201	
	○	P 1845		●	VKHB 2192	JF 9549/9510	VKS 6201	



					●	VKHB 2337	JT 9049/9010		
M 140/160	●	E 400			●	VKHB 2061	33211/Q	VKS 6239	54)
	●	E 400			●	VKHB 2065	33208/Q		
	●	E 5A - 221			●	VKHB 2061	33211/Q	VKS 6238	55)
	●	E 5A - 221			●	VKHB 2065	33208/Q		
	●	E 5A - 221			●	VKHB 2051	33213/Q	VKS 6202	53)
	●	E 5A - 221			●	VKHB 2067	33209/Q		
	●	E 5A - 221			●	VKHB 2051	33213/Q	VKS 6175	50)
	●	E 5A - 221			●	VKHB 2067	33209/Q		
	○	P 1140 D			●	VKHB 2051	33213/Q	VKS 6175	43)
	○	P 1141 D			●	VKHB 2068	33210/Q		
	○	P 1340 - A02			●	VKHB 2161	32019 X/Q	VKS 6201	
	○	P 1341 - A02			●	VKHB 2161	32019 X/Q	VKS 6201	
	○	P 769 - 02			●	VKHB 2192	JF 9549/9510	VKS 6201	
	○	P 769 - 02			●	VKHB 2158	33117/Q		
	○	P 769 - 02			●	VKHB 2192	JF 9549/9510	VKS 6201	
	○	P 769 - 02			●	VKHB 2194	33216/Q		
	○	P 941 - A01			●	VKHB 2161	32019 X/Q	VKS 6234	56)
	○	P 941 - A01			●	VKHB 2169	32017 X/Q		
	○	P 941 - A01			●	VKHB 2161	32019 X/Q	VKS 6201	57)
	○	P 941 - A01			●	VKHB 2169	32017 X/Q		
	○	P 941 - A01			●	VKHB 2161	32019 X/Q	VKS 6234	56)
	○	P 941 - A01			●	VKHB 2161	32019 X/Q	VKS 6201	57)
M 150/180	●	E 408 - 05			●	VKHB 2061	33211/Q	VKS 6239	
	○	P 821, P 1021			●	VKHB 2065	33208/Q		
					●			VKS 6234	
M 150/180 (VF6 40-ACA/ACC), M 180 (VF6 40-ACB/ACD)	●	E 400			●	VKHB 2061	33211/Q	VKS 6238	
	●	E 401			●	VKHB 2065	33208/Q		
	●	E 402			●	VKHB 2068	33210/Q		
	●	E 5A			●	VKHB 2182	33207/Q		
	●	E5A			●	VKHB 2067	33209/Q	VKS 6175	52)
	○	1140			●	VKHB 2182	33207/Q		
	○	1141			●	VKHB 2051	33213/Q	VKS 6175	43)
	○	1340			●	VKHB 2067	33209/Q		
	○	1341			●	VKHB 2067	33209/Q		
	○	669			●	VKHB 2051	33213/Q	VKS 6175	43)
	○	669			●	VKHB 2068	33210/Q		
	○	669			●	VKHB 2068	33210/Q	VKS 6175	43)
	○	669			●	VKHB 2161	32019 X/Q	VKS 6201	
	○	669			●	VKHB 2158	33117/Q		
	○	669			●	VKHB 2161	32019 X/Q	VKS 6201	
	○	669			●	VKHB 2192	JF 9549/9510	VKS 6201	
	○	669			●	VKHB 2158	33117/Q		
	○	669			●	VKHB 2192	JF 9549/9510	VKS 6201	
	○	669			●	VKHB 2194	33216/Q		
	○	669			●	VKHB 2044	33014	VKS 6237	61)





RENAULT (RVI) .../...

	<ul style="list-style-type: none"> ○ 669 ○ 769 - 02 ○ 769 - 05 			<ul style="list-style-type: none"> ● VKHB 2045 33012/Q ● VKHB 2282 32015 X/Q ● VKHB 2199 32013 X/Q ● VKHB 2161 32019 X/Q ● VKHB 2169 32017 X/Q ● VKHB 2046 33015/Q ● VKHB 2047 33013/Q 			<p>62)</p> <p>VKS 6201</p> <p>VKS 6237 VKS 6236</p>
M 150/180 (VF6 40-ACA/ACC), M 180 (VF6 40-ACB/ACD)	<ul style="list-style-type: none"> ○ 769 - 06 ○ 940 ○ 941 			<ul style="list-style-type: none"> ● VKHB 2282 32015 X/Q ● VKHB 2199 32013 X/Q ● VKHB 2161 32019 X/Q ● VKHB 2169 32017 X/Q ● VKHB 2161 32019 X/Q 			<p>VKS 6201</p> <p>VKS 6201</p>
M 180/210	<ul style="list-style-type: none"> ● E 408 - 05 ○ P 821, P 1021 			<ul style="list-style-type: none"> ● VKHB 2061 33211/Q ● VKHB 2065 33208/Q ● ● 			<p>VKS 6239</p> <p>VKS 6234</p>
M 200/230	<ul style="list-style-type: none"> ● E 400 ● E 400 ● E 5A - 221 ● E 5A - 221 ● E 5A - 221 ○ P 1140 D ○ P 1141 D ○ P 1340 - A02 ○ P 1341 - A02 ○ P 769 - 02 ○ P 769 - 02 ○ P 941 - A01 ○ P 941 - A01 			<ul style="list-style-type: none"> ● VKHB 2061 33211/Q ● VKHB 2065 33208/Q ● VKHB 2061 33211/Q ● VKHB 2065 33208/Q ● VKHB 2051 33213/Q ● VKHB 2067 33209/Q ● VKHB 2051 33213/Q ● VKHB 2067 33209/Q ● VKHB 2051 33213/Q ● VKHB 2068 33210/Q ● VKHB 2161 32019 X/Q ● VKHB 2161 32019 X/Q ● VKHB 2192 JF 9549/9510 ● VKHB 2158 33117/Q ● VKHB 2192 JF 9549/9510 ● VKHB 2194 33216/Q ● VKHB 2161 32019 X/Q ● VKHB 2169 32017 X/Q ● VKHB 2161 32019 X/Q ● VKHB 2169 32017 X/Q ● VKHB 2161 32019 X/Q ● VKHB 2161 32019 X/Q 		<p>VKS 6239 54)</p> <p>VKS 6238 55)</p> <p>VKS 6202 53)</p> <p>VKS 6175 50)</p> <p>VKS 6175 43)</p> <p>VKS 6201</p> <p>VKS 6201</p> <p>VKS 6201</p> <p>VKS 6201</p> <p>VKS 6234 56)</p> <p>VKS 6201 57)</p> <p>VKS 6234 56)</p> <p>VKS 6201 57)</p>	
M 210/230 TI (VF6- 40)	<ul style="list-style-type: none"> ● E 400 			<ul style="list-style-type: none"> ● VKHB 2061 33211/Q ● VKHB 2065 33208/Q 			<p>VKS 6238</p>



	•	E 401			•	VKHB 2068	33210/Q		
	•	E 402			•	VKHB 2182	33207/Q		
	•	E 5A			•	VKHB 2067	33209/Q		
	•	E 5A			•	VKHB 2182	33207/Q		
	•	E 5A			•	VKHB 2051	33213/Q	VKS 6175	52)
	•	E 5A			•	VKHB 2067	33209/Q		
	○	1140			•	VKHB 2051	33213/Q	VKS 6175	43)
	○	1141			•	VKHB 2068	33210/Q		
	○	1340			•	VKHB 2161	32019 X/Q	VKS 6201	
	○	1341			•	VKHB 2158	33117/Q		
	○	669			•	VKHB 2161	32019 X/Q	VKS 6201	
	○	669			•	VKHB 2192	JF 9549/9510	VKS 6201	
	○	669			•	VKHB 2158	33117/Q		
	○	769 - 06			•	VKHB 2192	JF 9549/9510	VKS 6201	
	○	769 - 05			•	VKHB 2194	33216/Q		
	○	769 - 02			•	VKHB 2044	33014	VKS 6237	61)
	○	940			•	VKHB 2045	33012/Q		
	○	941			•	VKHB 2282	32015 X/Q		62)
	○				•	VKHB 2199	32013 X/Q		
	○				•	VKHB 2282	32015 X/Q		
	○				•	VKHB 2199	32013 X/Q		
	○				•	VKHB 2046	33015/Q	VKS 6237	
	○				•	VKHB 2047	33013/Q	VKS 6236	
	○				•	VKHB 2161	32019 X/Q	VKS 6201	
	○				•	VKHB 2169	32017 X/Q		
	○				•	VKHB 2161	32019 X/Q	VKS 6201	
	○				•	VKHB 2169	32017 X/Q		
	○				•	VKHB 2161	32019 X/Q	VKS 6201	
	○				•				
M250	•	E5A			•	VKHB 2051	33213/Q	VKS 6175	52)
	•	E5A			•	VKHB 2067	33209/Q		
	•	E5A			•	VKHB 2051	33213/Q	VKS 6175	43)
	○	1140			•	VKHB 2068	33210/Q		
	○	1140			•	VKHB 2161	32019 X/Q		84)
	○	1141			•	VKHB 2161	32019 X/Q	VKS 6201	85)
	○	1340			•	VKHB 2158	33117/Q		
	○	1341			•	VKHB 2161	32019 X/Q	VKS 6201	
	○	669-03			•	VKHB 2192	JF 9549/9510	VKS 6201	
	○	669-03			•	VKHB 2158	33117/Q		
	○	669-05			•	VKHB 2192	JF 9549/9510	VKS 6201	
	○	769-02			•	VKHB 2194	33216/Q		
	○				•	VKHB 2044	33014		86)
	○				•	VKHB 2045	33012/Q		
	○				•	VKHB 2282	32015 X/Q		87)
	○				•	VKHB 2199	32013 X/Q		
	○				•	VKHB 2282	32015 X/Q		
	○				•	VKHB 2199	32013 X/Q		
	○				•	VKHB 2161	32019 X/Q	VKS 6201	
	○				•	VKHB 2169	32017 X/Q		





RENAULT (RVI) .../...

	<ul style="list-style-type: none"> ○ 769-05 ○ 769-06 ○ 940 ○ 941 			<ul style="list-style-type: none"> ● VKHB 2046 33015/Q ● VKHB 2047 33013/Q ● VKHB 2282 32015 X/Q ● VKHB 2199 32013 X/Q ● VKHB 2161 32019 X/Q ● VKHB 2169 32017 X/Q ● VKHB 2161 32019 X/Q 	<ul style="list-style-type: none"> VKS 6237 VKS 6236 VKS 6201 VKS 6201
ME 160 (VF6-JE 13) 4x2	<ul style="list-style-type: none"> ● E 400-04/14 ● E 408-AA ● E 408-05/ 13/15/ 24 	VKBA 5342		<ul style="list-style-type: none"> ● VKHB 2061 33211/Q ● VKHB 2065 33208/Q ● VKHB 2066 33214/Q ● VKHB 2068 33210/Q ● VKHB 2061 33211/Q ● VKHB 2065 33208/Q 	<ul style="list-style-type: none"> VKS 6239 VKS 6303 VKS 6239
ME 160 (VF6-JE 13) 4x4	<ul style="list-style-type: none"> ● 			<ul style="list-style-type: none"> ● VKHB 2169 32017 X/Q ● VKHB 2169 32017 X/Q 	
ME 160 (VF6-JE 13) 4x2, 4x4	<ul style="list-style-type: none"> ○ P 821-13/17 ○ P 1021-03 ○ P 1040 F ○ P 1041 F ○ P 1140 F ○ P 1141 F 			<ul style="list-style-type: none"> ● ● ● VKHB 2161 32019 X/Q ● VKHB 2158 33117/Q ● VKHB 2161 32019 X/Q ● VKHB 2161 32019 X/Q ● VKHB 2158 33117/Q ● VKHB 2161 32019 X/Q 	<ul style="list-style-type: none"> VKS 6234 VKS 6234 VKS 6201 VKS 6201 VKS 6201 VKS 6201
ME 160/180 (VF6-JE 15) 4x2	<ul style="list-style-type: none"> ● E 400-04/14 ● E 408-AA ● E 408-05/ 13/15/ 24 ○ P 821-13/17 ○ P 1021-03 ○ P 1040 F ○ P 1041 F ○ P 1140 F ○ P 1141 F 	VKBA 5342		<ul style="list-style-type: none"> ● VKHB 2061 33211/Q ● VKHB 2065 33208/Q ● VKHB 2066 33214/Q ● VKHB 2068 33210/Q ● VKHB 2061 33211/Q ● VKHB 2065 33208/Q ● ● ● VKHB 2161 32019 X/Q ● VKHB 2158 33117/Q ● VKHB 2161 32019 X/Q ● ● VKHB 2161 32019 X/Q ● VKHB 2158 33117/Q ● VKHB 2161 32019 X/Q 	<ul style="list-style-type: none"> VKS 6239 VKS 6303 VKS 6239 VKS 6234 VKS 6234 VKS 6201 VKS 6201 VKS 6201 VKS 6201 VKS 6201



					•				
PA 160/180 Maroc	•	E 400			•	VKHB 2061 VKHB 2065	33211/Q 33208/Q	VKS 6239	54)
	•	E 400			•	VKHB 2061 VKHB 2065	33211/Q 33208/Q	VKS 6238	55)
	•	E 5A - 221			•	VKHB 2051 VKHB 2067	33213/Q 33209/Q	VKS 6202	53)
	•	E 5A - 221			•	VKHB 2051 VKHB 2067	33213/Q 33209/Q	VKS 6175	50)
	•	E 5A - 221			•	VKHB 2051 VKHB 2068	33213/Q 33210/Q	VKS 6175	43)
	○	P 1140 D			•	VKHB 2161	32019 X/Q	VKS 6201	
	○	P 1141 D			•	VKHB 2161	32019 X/Q	VKS 6201	
	○	P 1340 - A02			•	VKHB 2192 VKHB 2158	JF 9549/9510 33117/Q	VKS 6201	
	○	P 1341 - A02			•	VKHB 2192 VKHB 2194	JF 9549/9510 33216/Q	VKS 6201	
	○	P 769 - 02			•	VKHB 2161 VKHB 2169	32019 X/Q 32017 X/Q	VKS 6234	56)
	○	P 769 - 02			•	VKHB 2161 VKHB 2169	32019 X/Q 32017 X/Q	VKS 6201	57)
	○	P 941 - A01			•	VKHB 2161	32019 X/Q	VKS 6234	56)
	○	P 941 - A01			•	VKHB 2161	32019 X/Q	VKS 6201	57)
PC 27 S	•	401			•	VKHB 2068 VKHB 2182	33210/Q 33207/Q	VKS 6235	58)
	○	769			•	VKHB 2046 VKHB 2047	33015/Q 33013/Q	VKS 6237 VKS 6236	58)
PP 160/180	•	E 400 - 06/16			•	VKHB 2061 VKHB 2065	33211/Q 33208/Q	VKS 6239	
	•	E 401 - 03			•	VKHB 2068 VKHB 2182	33210/Q 33207/Q	VKS 6235	
	○	R 769 - 01			•	VKHB 2046 VKHB 2047	33015/Q 33013/Q	VKS 6237 VKS 6236	
	○	R 769 - 02			•	VKHB 2161 VKHB 2169	32019 X/Q 32017 X/Q	VKS 6201	
Premium 260 SP	•	-	VKBA 5308		•				107)
	○	P 1341			•	VKHB 2192 VKHB 2194	JF 9549/9510 33216/Q	VKS 6201	
	○	P 1370			•	VKHB 2192 VKHB 2158	JF 9549/9510 33117/Q	VKS 6201	
Premium 6x2, 6x2/4	•		VKBA 5308		•				107)
	○	Trailing axle	VKBA 5308		•				















RENAULT (RVI)

.../...

	<ul style="list-style-type: none"> ○ - ○ P 1340 ○ P 1341 ○ P 1342, P 1345 			<ul style="list-style-type: none"> ● ● ● ● ● ● 	<ul style="list-style-type: none"> VKHB 2161 32019 X/Q VKHB 2158 33117/Q VKHB 2192 JF 9549/9510 VKHB 2158 33117/Q VKHB 2192 JF 9549/9510 VKHB 2194 33216/Q VKHB 2192 JF 9549/9510 VKHB 2337 JT 9049/9010 	<ul style="list-style-type: none"> VKS 6201 108) VKS 6201 109) VKS 6201 VKS 6201 	
Premium 6x2 Pusher FAB 22C	<ul style="list-style-type: none"> ● - ○ P 1342, P 1345 ○ P 1370 	VKBA 5308		<ul style="list-style-type: none"> ● ● ● ● 	<ul style="list-style-type: none"> VKHB 2192 JF 9549/9510 VKHB 2337 JT 9049/9010 VKHB 2192 JF 9549/9510 VKHB 2158 33117/Q 	<ul style="list-style-type: none"> VKS 6201 VKS 6201 	107)
Premium 6x2 Pusher FAB 22A	<ul style="list-style-type: none"> ● - ○ P 1340 ○ P 1341 ○ P 1342, P 1345 	VKBA 5308		<ul style="list-style-type: none"> ● ● ● ● 	<ul style="list-style-type: none"> VKHB 2192 JF 9549/9510 VKHB 2158 33117/Q VKHB 2192 JF 9549/9510 VKHB 2194 33216/Q VKHB 2192 JF 9549/9510 VKHB 2337 JT 9049/9010 	<ul style="list-style-type: none"> VKS 6201 VKS 6201 VKS 6201 	107)
Premium PR / TR 4x2	<ul style="list-style-type: none"> ● - ○ P 1340, P 1370 ○ P 1341 ○ P 1345 	VKBA 5308		<ul style="list-style-type: none"> ● ● ● ● 	<ul style="list-style-type: none"> VKHB 2192 JF 9549/9510 VKHB 2158 33117/Q VKHB 2192 JF 9549/9510 VKHB 2194 33216/Q VKHB 2192 JF 9549/9510 VKHB 2337 JT 9049/9010 	<ul style="list-style-type: none"> VKS 6201 VKS 6201 	107)
Midliner Grand Bretagne	<ul style="list-style-type: none"> ● E 402-15 ● E 401-14 ● E 400 ● E 400 ● E 5A 221 ● E 5A 22 ● E 5A 22 ○ 669-03 			<ul style="list-style-type: none"> ● ● ● ● ● ● ● ● 	<ul style="list-style-type: none"> VKHB 2067 33209/Q VKHB 2179 33206/Q VKHB 2068 33210/Q VKHB 2182 33207/Q VKHB 2061 33211/Q VKHB 2065 33208/Q VKHB 2061 33211/Q VKHB 2065 33208/Q VKHB 2051 33213/Q VKHB 2067 33209/Q VKHB 2051 33213/Q VKHB 2067 33209/Q VKHB 2051 33213/Q VKHB 2068 33210/Q VKHB 2044 33014 	<ul style="list-style-type: none"> VKS 6235 VKS 6238 54) VKS 6238 55) VKS 6202 VKS 6175 110) VKS 6175 43) 	











									
	<ul style="list-style-type: none"> ○ 769-01, 769-05 ○ 769-02 ○ 769-02 ○ P 1140 ○ P 1141 				<ul style="list-style-type: none"> ● ● ● ● ● ● ● ● ● 	<ul style="list-style-type: none"> VKHB 2045 33012/Q VKHB 2046 33015/Q VKHB 2047 33013/Q VKHB 2161 32019 X/Q VKHB 2169 32017 X/Q VKHB 2161 32019 X/Q VKHB 2169 32017 X/Q VKHB 2161 32019 X/Q VKHB 2158 33117/Q VKHB 2161 32019 X/Q 	<ul style="list-style-type: none"> VKS 6219 VKS 6237 VKS 6236 VKS 6234 56) VKS 6201 57) VKS 6201 VKS 6201 		
Midlum (FAB 43E1-43E2)	<ul style="list-style-type: none"> ○ P 1140 / 1120 SLA ○ P 1141 				<ul style="list-style-type: none"> ● ● ● 	<ul style="list-style-type: none"> VKHB 2192 JF 9549/9510 VKHB 2158 33117/Q VKHB 2161 32019 X/Q 	<ul style="list-style-type: none"> VKS 6201 VKS 6201 		
Midlum (42B3/4-44T)	<ul style="list-style-type: none"> ○ P 669 ○ P 920 ○ 1120 / 1170 ○ 1121 				<ul style="list-style-type: none"> ● ● ● ● ● ● 	<ul style="list-style-type: none"> VKHB 2199 32013 X/Q VKHB 2338 JLM 714149/ JLM 714110 VKHB 2169 32017 X/Q VKHB 2338 JLM 714149/ JLM 714110 VKHB 2161 32019 X/Q VKHB 2158 33117/Q VKHB 2161 32019 X/Q VKHB 2194 33216/Q 	<ul style="list-style-type: none"> VKS 6375 VKS 6375 VKS 6234 VKS 6234 		
Midlum (FAB 42US-44US-45US)	<ul style="list-style-type: none"> ○ P 920 ○ 1120 / 1170 ○ 1121 				<ul style="list-style-type: none"> ● ● ● ● 	<ul style="list-style-type: none"> VKHB 2169 32017 X/Q VKHB 2338 JLM 714149/ JLM 714110 VKHB 2161 32019 X/Q VKHB 2158 33117/Q VKHB 2161 32019 X/Q VKHB 2194 33216/Q 	<ul style="list-style-type: none"> VKS 6375 VKS 6234 VKS 6234 		
Midlum (FAB 42B1/ 2-43C1/2-43T/V)	<ul style="list-style-type: none"> ● E 62 AD ○ P 669 ○ P 920 ○ P 1120 / 1140 L ○ P 1141 L 	VKBA 5407			<ul style="list-style-type: none"> ● ● ● ● ● ● 	<ul style="list-style-type: none"> VKHB 2199 32013 X/Q VKHB 2338 JLM 714149/ JLM 714110 VKHB 2169 32017 X/Q VKHB 2338 JLM 714149/ JLM 714110 VKHB 2192 JF 9549/9510 VKHB 2158 33117/Q VKHB 2192 JF 9549/9510 	<ul style="list-style-type: none"> VKS 6375 VKS 6375 VKS 6201 VKS 6201 	111)	
PS 130-09/150-09	<ul style="list-style-type: none"> ● 401 ○ 769 				<ul style="list-style-type: none"> ● ● ● 	<ul style="list-style-type: none"> VKHB 2068 33210/Q VKHB 2182 33207/Q VKHB 2046 33015/Q 	<ul style="list-style-type: none"> VKS 6235 66) VKS 6237 		





RENAULT (RVI) .../...

	○ SOMA 95 HD			●	VKHB 2047	33013/Q	VKS 6236	
				●	VKHB 2046	33015/Q	VKS 6237	
				●	VKHB 2047	33013/Q	VKS 6236	
PS 150 Carrier	● 401			●	VKHB 2068	33210/Q	VKS 6235	58)
	○ 769			●	VKHB 2182	33207/Q		
				●	VKHB 2046	33015/Q	VKS 6237	58)
				●	VKHB 2047	33013/Q	VKS 6236	
PS 150/160	● E 400 - 06/16			●	VKHB 2061	33211/Q	VKS 6239	
	● E 401 - 03			●	VKHB 2065	33208/Q		
	○ R 769 - 01			●	VKHB 2068	33210/Q	VKS 6235	
	○ R 769 - 02			●	VKHB 2182	33207/Q		
				●	VKHB 2046	33015/Q	VKS 6237	
				●	VKHB 2047	33013/Q	VKS 6236	
				●	VKHB 2161	32019 X/Q	VKS 6201	
				●	VKHB 2169	32017 X/Q		
PX 28/28 T	● E 6A			●	VKHB 2066	33214/Q	VKS 6175	
	○ P 1332			●	VKHB 2067	33209/Q		
				●	VKHB 2186	JHM 720249/ JHM 720210	VKS 6201	
				●	VKHB 2187	64432/64708		
PX 30 V/VT	● E 6A - 21			●	VKHB 2066	33214/Q	VKS 6175	
	○ PMA 1021, PMA 1321			●	VKHB 2067	33209/Q		
	○ PMA 1032 B, PMA 1532			●	VKHB 2185	52375/52618 683/372	VKS 6201	
				●	VKHB 2042			
				●	VKHB 2186	JHM 720249/ JHM 720210	VKS 6201	
				●	VKHB 2187	64432/64708		
PX 30/30 T	● E 6A			●	VKHB 2066	33214/Q	VKS 6175	
	○ P 1332, P 1332 B			●	VKHB 2067	33209/Q		
				●	VKHB 2186	JHM 720249/ JHM 720210	VKS 6201	
				●	VKHB 2187	64432/64708		
PX 40 V/VT/VTs	● E 6A			●	VKHB 2066	33214/Q	VKS 6175	
	○ PMA/PR 1032 B, PMA/P 1532			●	VKHB 2067	33209/Q		
	○ PMA/PR/P 1021, PMA/PR 1321			●	VKHB 2186	JHM 720249/ JHM 720210	VKS 6201	
				●	VKHB 2187	64432/64708		
				●	VKHB 2185	52375/52618 683/372	VKS 6201	
				●	VKHB 2042			
R 310/310 T 6x4	● E6A			●	VKHB 2066	33214/Q	VKS 6175	23)
				●	VKHB 2067	33209/Q		

									
	<ul style="list-style-type: none"> ● E6A ○ PMA/PR 1321 ○ PMA/P 1532 				<ul style="list-style-type: none"> ● VKHB 2066 ● VKHB 2184 ● VKHB 2185 ● VKHB 2042 ● VKHB 2186 ● VKHB 2187 	<ul style="list-style-type: none"> 33214/Q T2ED 045 52375/52618 683/372 JHM 720249/ JHM 720210 64432/64708 	<ul style="list-style-type: none"> VKS 6175 VKS 6201 VKS 6201 	24)	
R 310/330/340/365	<ul style="list-style-type: none"> ● E 6A ○ P 1332, PMA/ P 1532 ○ P 1345 ○ PR 1341 				<ul style="list-style-type: none"> ● VKHB 2066 ● VKHB 2184 ● VKHB 2186 ● VKHB 2187 ● VKHB 2192 ● VKHB 2192 ● VKHB 2194 	<ul style="list-style-type: none"> 33214/Q T2ED 045 JHM 720249/ JHM 720210 64432/64708 JF 9549/9510 JF 9549/9510 33216/Q 	<ul style="list-style-type: none"> VKS 6175 VKS 6201 VKS 6201 VKS 6201 		
R 340 TI	<ul style="list-style-type: none"> ● E 6A - 32 ● E 6A - 32, E 6A - 33 ● E 6A - 32/33/ 211/311, E 6B - 211/311 ● E 84 - AG/EG/ GG, E 85 - CM ● E 85 - JH ○ P 1332, PMA/ P 1532 ○ PMA/PR 1341 ○ P 1345 	<ul style="list-style-type: none"> VKBA 5308 VKBA 5308 			<ul style="list-style-type: none"> ● VKHB 2066 ● VKHB 2184 ● VKHB 2066 ● VKHB 2184 ● VKHB 2066 ● VKHB 2184 ● VKHB 2186 ● VKHB 2187 ● VKHB 2192 ● VKHB 2194 ● VKHB 2192 	<ul style="list-style-type: none"> 33214/Q T2ED 045 33214/Q T2ED 045 33214/Q T2ED 045 JHM 720249/ JHM 720210 64432/64708 JF 9549/9510 33216/Q JF 9549/9510 	<ul style="list-style-type: none"> VKS 6175 VKS 6202 VKS 6175 VKS 6201 VKS 6201 VKS 6201 	48) 49) 51) 47)	
R 350	<ul style="list-style-type: none"> ● E 6A - 32 ● E 6A - 32, E 6A - 33 ● E 6A - 32/33/ 211/311, E 6B - 211/311 ● E 84 - AG/EG/ GG, E 85 - CM ● E 85 - JH 	<ul style="list-style-type: none"> VKBA 5308 VKBA 5308 			<ul style="list-style-type: none"> ● VKHB 2066 ● VKHB 2184 ● VKHB 2066 ● VKHB 2184 ● VKHB 2066 ● VKHB 2184 	<ul style="list-style-type: none"> 33214/Q T2ED 045 33214/Q T2ED 045 33214/Q T2ED 045 	<ul style="list-style-type: none"> VKS 6175 VKS 6202 VKS 6175 	48) 49) 51) 47)	





RENAULT (RVI)

.../...

○ P 1332, PMA/
P 1532

● VKHB 2186 JHM 720249/
JHM 720210
● VKHB 2187 64432/64708

VKS 6201

○ PMA/PR 1341

● VKHB 2192 JF 9549/9510
● VKHB 2194 33216/Q

VKS 6201

○ P 1345

● VKHB 2192 JF 9549/9510

VKS 6201

R 360/360 T

- E 6A
- E 6A
- P 1332 B/B1,
P 1332 E 42

● VKHB 2066 33214/Q
● VKHB 2067 33209/Q

● VKHB 2066 33214/Q
● VKHB 2184 T2ED 045

● VKHB 2186 JHM 720249/
JHM 720210
● VKHB 2187 64432/64708

VKS 6175 23)

VKS 6175 24)

VKS 6201

R 360/360 T 6x4

- RD
- RD
- PMA/PR 1321
- PMA/P 1532

● VKHB 2066 33214/Q
● VKHB 2067 33209/Q

● VKHB 2066 33214/Q
● VKHB 2184 T2ED 045

● VKHB 2185 52375/52618
● VKHB 2042 683/372

● VKHB 2186 JHM 720249/
JHM 720210
● VKHB 2187 64432/64708

VKS 6175 23)

VKS 6175 24)

VKS 6201

VKS 6201

R 370

- E 6A
- E 6A
- P 1332
- P 1345

● VKHB 2066 33214/Q
● VKHB 2184 T2ED 045

● VKHB 2066 33214/Q
● VKHB 2184 T2ED 045

● VKHB 2186 JHM 720249/
JHM 720210
● VKHB 2187 64432/64708

● VKHB 2192 JF 9549/9510

VKS 6175

VKS 6202

VKS 6201

VKS 6201

R 370 (6x4)

- E 6A
- E 6A
- PMA/P 1341
- PMA/PR 1532

● VKHB 2066 33214/Q
● VKHB 2184 T2ED 045

● VKHB 2066 33214/Q
● VKHB 2184 T2ED 045

● VKHB 2192 JF 9549/9510
● VKHB 2194 33216/Q

● VKHB 2186 JHM 720249/
JHM 720210
● VKHB 2187 64432/64708

VKS 6175

VKS 6202

VKS 6201

VKS 6201

R 370 T











- E 6A
- E 6A

● VKHB 2066 33214/Q
● VKHB 2184 T2ED 045

● VKHB 2066 33214/Q

VKS 6175

VKS 6202

										
		○ P 1332			●	VKHB 2184	T2ED 045			
		○ P 1345			●	VKHB 2186	JHM 720249/ JHM 720210 64432/64708	VKS 6201		
					●	VKHB 2187	64432/64708			
					●	VKHB 2192	JF 9549/9510	VKS 6201		
					●					
R 380	●	E 6A - 32			●	VKHB 2066	33214/Q	VKS 6175	48)	
	●	E 6A - 32, E 6A - 33			●	VKHB 2184	T2ED 045			
	●	E 6A - 32/33/ 211/311, E 6B - 211/311			●	VKHB 2066	33214/Q	VKS 6202	49)	
	●	E 85 JH	VKBA 5308		●	VKHB 2184	T2ED 045			
	○	P 1332, PMA/ P 1532			●	VKHB 2066	33214/Q	VKS 6175	51)	
	○	PMA/PR 1341			●	VKHB 2184	T2ED 045			
	○	P 1345			●	VKHB 2186	JHM 720249/ JHM 720210 64432/64708	VKS 6201		
					●	VKHB 2187	64432/64708			
					●	VKHB 2192	JF 9549/9510	VKS 6201		
					●	VKHB 2194	33216/Q			
					●	VKHB 2192	JF 9549/9510	VKS 6201		
					●					
R 385 TI	●	E 6A - 32			●	VKHB 2066	33214/Q	VKS 6175	48)	
	●	E 6A - 32, E 6A - 33			●	VKHB 2184	T2ED 045			
	●	E 6A - 32/33/ 211/311, E 6B - 211/311			●	VKHB 2066	33214/Q	VKS 6202	49)	
	●	E 84 AG/EG/ GG, E 85 CM	VKBA 5308		●	VKHB 2184	T2ED 045	VKS 6175	51)	
	●	E 85 - JH	VKBA 5308		●					47)
	○	P 1332, PMA/ P 1532			●	VKHB 2066	33214/Q	VKS 6175		
	○	PMA/PR 1341			●	VKHB 2184	T2ED 045			
	○	P 1345			●	VKHB 2186	JHM 720249/ JHM 720210 64432/64708	VKS 6201		
					●	VKHB 2187	64432/64708			
					●	VKHB 2192	JF 9549/9510	VKS 6201		
					●	VKHB 2194	33216/Q			
					●	VKHB 2192	JF 9549/9510	VKS 6201		
					●					
R 390	●	E 6A			●	VKHB 2066	33214/Q	VKS 6175		
	●	E 6A			●	VKHB 2184	T2ED 045			
					●	VKHB 2066	33214/Q	VKS 6202		
					●	VKHB 2184	T2ED 045			





RENAULT (RVI) .../...

	<ul style="list-style-type: none"> ○ P 1332 ○ P 1345 			<ul style="list-style-type: none"> ● VKHB 2186 ● VKHB 2187 ● VKHB 2192 	<p>JHM 720249/ JHM 720210 64432/64708</p> <p>JF 9549/9510</p>	<p>VKS 6201</p> <p>VKS 6201</p>
R 390 (6x4)	<ul style="list-style-type: none"> ● E 6A ● E 6A ○ PMA/PR 1341 ○ PMA/PR 1532 			<ul style="list-style-type: none"> ● VKHB 2066 ● VKHB 2184 ● VKHB 2066 ● VKHB 2184 ● VKHB 2192 ● VKHB 2194 ● VKHB 2186 ● VKHB 2187 	<p>33214/Q T2ED 045</p> <p>33214/Q T2ED 045</p> <p>JF 9549/9510 33216/Q</p> <p>JHM 720249/ JHM 720210 64432/64708</p>	<p>VKS 6175</p> <p>VKS 6202</p> <p>VKS 6201</p> <p>VKS 6201</p>
R 390 T	<ul style="list-style-type: none"> ● E 6A ● E 6A ○ P 1332 ○ P 1345 			<ul style="list-style-type: none"> ● VKHB 2066 ● VKHB 2184 ● VKHB 2066 ● VKHB 2184 ● VKHB 2186 ● VKHB 2187 ● VKHB 2192 	<p>33214/Q T2ED 045</p> <p>33214/Q T2ED 045</p> <p>JHM 720249/ JHM 720210 64432/64708</p> <p>JF 9549/9510</p>	<p>VKS 6175</p> <p>VKS 6202</p> <p>VKS 6201</p> <p>VKS 6201</p>
R 420	<ul style="list-style-type: none"> ● E 6A ● E 6A ○ P 1332 ○ P 1345 			<ul style="list-style-type: none"> ● VKHB 2066 ● VKHB 2184 ● VKHB 2066 ● VKHB 2184 ● VKHB 2186 ● VKHB 2187 ● VKHB 2192 	<p>33214/Q T2ED 045</p> <p>33214/Q T2ED 045</p> <p>JHM 720249/ JHM 720210 64432/64708</p> <p>JF 9549/9510</p>	<p>VKS 6175</p> <p>VKS 6202</p> <p>VKS 6201</p> <p>VKS 6201</p>
R 420 6x4	<ul style="list-style-type: none"> ● E 6A ● E 6A ○ PMA/PR 1341 ○ PMA/PR 1532 			<ul style="list-style-type: none"> ● VKHB 2066 ● VKHB 2184 ● VKHB 2066 ● VKHB 2184 ● VKHB 2192 ● VKHB 2194 ● VKHB 2186 ● VKHB 2187 	<p>33214/Q T2ED 045</p> <p>33214/Q T2ED 045</p> <p>JF 9549/9510 33216/Q</p> <p>JHM 720249/ JHM 720210 64432/64708</p>	<p>VKS 6175</p> <p>VKS 6202</p> <p>VKS 6201</p> <p>VKS 6201</p>
R 420 T	<ul style="list-style-type: none"> ○ P 1332 ○ P 1345 			<ul style="list-style-type: none"> ● VKHB 2186 ● VKHB 2187 ● VKHB 2192 	<p>JHM 720249/ JHM 720210 64432/64708</p> <p>JF 9549/9510</p>	<p>VKS 6201</p> <p>VKS 6201</p>













R 420 TI	•	E 6A - 32	VKBA 5308	VKBA 5308	•	VKHB 2066 VKHB 2184	33214/Q T2ED 045	VKS 6175	48)
	•	E 6A - 32, E 6A - 33			•	VKHB 2066 VKHB 2184	33214/Q T2ED 045	VKS 6202	49)
	•	E 6A - 32/33/ 211/311, E 6B - 211/311			•	VKHB 2066 VKHB 2184	33214/Q T2ED 045	VKS 6175	51)
	•	E 84 - AG/EG/ GG, E 85 - CM			•				47)
	•	E 85 - JH			•				
	○	P 1332, PMA/ P 1532			•	VKHB 2186	JHM 720249/ JHM 720210	VKS 6201	
	○	PMA/PR 1341			•	VKHB 2187	64432/64708	VKS 6201	
	○	P 1345			•	VKHB 2192 VKHB 2194	JF 9549/9510 33216/Q	VKS 6201	
R 6x4 TS	•	E 6A -32	VKBA 5308	VKBA 5308	•	VKHB 2066 VKHB 2184	33214/Q T2ED 045	VKS 6175	48)
	•	E 6A - 32, E 6A - 33			•	VKHB 2066 VKHB 2184	33214/Q T2ED 045	VKS 6202	49)
	•	E 6A - 32/33/ 211/311, E 6B - 211/311			•	VKHB 2066 VKHB 2184	33214/Q T2ED 045	VKS 6175	51)
	•	E 84 - AG/EG/ GG, E 85 - CM			•				47)
	•	E 85 - JH			•				
	○	P 1332, PMA/ P 1532			•	VKHB 2186	JHM 720249/ JHM 720210	VKS 6201	
	○	PMA/PR 1341			•	VKHB 2187	64432/64708	VKS 6201	
	○	P 1345			•	VKHB 2192 VKHB 2194	JF 9549/9510 33216/Q	VKS 6201	
RI 357	•	E 6A			•	VKHB 2066 VKHB 2184	33214/Q T2ED 045	VKS 6175	
	○	P 1332, PMA/ P 1532			•	VKHB 2186	JHM 720249/ JHM 720210	VKS 6201	
	○	P 1345			•	VKHB 2187	64432/64708	VKS 6201	
	○	PMA/PR 1341			•	VKHB 2192	JF 9549/9510	VKS 6201	





RENAULT (RVI) .../...

					●	VKHB 2194	33216/Q		
S 90 - 09 (VF6 JN)	●	401			●	VKHB 2067	33209/Q		65)
	●	401			●	VKHB 2294	32305 J2		
	○	SOMA 95			●	VKHB 2068	33210/Q	VKS 6235	66)
	○	769 - 01			●	VKHB 2182	33207/Q		
					●	VKHB 2046	33015/Q	VKS 6237	
					●	VKHB 2047	33013/Q	VKS 6236	
					●	VKHB 2046	33015/Q	VKS 6237	
					●	VKHB 2047	33013/Q	VKS 6236	
S 100 (VF6 JK)	●	401			●	VKHB 2068	33210/Q	VKS 6235	
	●	402			●	VKHB 2182	33207/Q		
	○	669			●	VKHB 2067	33209/Q		
	○	SOMA 95			●	VKHB 2179	33206/Q		
	○	769			●	VKHB 2044	33014	VKS 6237	
					●	VKHB 2045	33012/Q	VKS 6219	
					●	VKHB 2046	33015/Q	VKS 6237	18)
					●	VKHB 2047	33013/Q	VKS 6236	
					●	VKHB 2046	33015/Q	VKS 6237	19)
					●	VKHB 2047	33013/Q	VKS 6236	
S 110/130 (VF6 JK)	●	402			●	VKHB 2067	33209/Q		
	○	669			●	VKHB 2179	33206/Q		
					●	VKHB 2044	33014	VKS 6237	
					●	VKHB 2045	33012/Q	VKS 6219	
S 120/135 (VF6)	●	401			●	VKHB 2068	33210/Q	VKS 6235	59)
	●	401			●	VKHB 2182	33207/Q		60)
	●	402			●	VKHB 2068	33210/Q		59)
	●	402			●	VKHB 2182	33207/Q		60)
	○	669			●	VKHB 2067	33209/Q		61)
	○	669			●	VKHB 2179	33206/Q		62)
	○	769			●	VKHB 2067	33209/Q		
					●	VKHB 2182	33207/Q	VKS 6237	
					●	VKHB 2044	33014		
					●	VKHB 2045	33012/Q		
					●	VKHB 2282	32015 X/Q		
					●	VKHB 2199	32013 X/Q		
					●	VKHB 2046	33015/Q	VKS 6237	
					●	VKHB 2047	33013/Q	VKS 6236	
S 130 - 06/08/09 (VF6 JN)	●	401			●	VKHB 2067	33209/Q		65)
	●	401			●	VKHB 2294	32305 J2		66)
	○	SOMA 95			●	VKHB 2068	33210/Q	VKS 6235	
	○	769 - 01			●	VKHB 2182	33207/Q		
					●	VKHB 2046	33015/Q	VKS 6237	
					●	VKHB 2047	33013/Q	VKS 6236	
					●	VKHB 2046	33015/Q	VKS 6237	
					●	VKHB 2047	33013/Q	VKS 6236	

									
S 130/150/170 (VF6 JP)	<ul style="list-style-type: none"> ● 400 ○ P 620, P 820 ○ P 821 				<ul style="list-style-type: none"> ● VKHB 2061 ● VKHB 2065 ● VKHB 2048 ● VKHB 2046 ● 	33211/Q 33208/Q 33018/Q 33015/Q	VKS 6239 VKS 6234 VKS 6234		
S 135/150 (VF6 AE)	<ul style="list-style-type: none"> ● 401 ● 402 ○ 669 ○ 769 				<ul style="list-style-type: none"> ● VKHB 2068 ● VKHB 2182 ● VKHB 2067 ● VKHB 2182 ● VKHB 2282 ● VKHB 2199 ● VKHB 2046 ● VKHB 2047 	33210/Q 33207/Q 33209/Q 33207/Q 32015 X/Q 32013 X/Q 33015/Q 33013/Q	VKS 6237 VKS 6236		
S 140/160 (VF6)	<ul style="list-style-type: none"> ● 401 ● 401 ● 402 ● 402 ○ 669 ○ 769 				<ul style="list-style-type: none"> ● VKHB 2068 ● VKHB 2182 ● VKHB 2068 ● VKHB 2182 ● VKHB 2067 ● VKHB 2179 ● VKHB 2067 ● VKHB 2182 ● VKHB 2044 ● VKHB 2045 ● VKHB 2046 ● VKHB 2047 	33210/Q 33207/Q 33210/Q 33207/Q 33209/Q 33206/Q 33209/Q 33207/Q 33014 33012/Q 33015/Q 33013/Q	VKS 6235 VKS 6237 VKS 6237 VKS 6236	63) 64) 63) 64)	
S 150 - 06/08/09 (VF6 JN)	<ul style="list-style-type: none"> ● 401 ● 401 ○ SOMA 95 ○ 769 - 01 				<ul style="list-style-type: none"> ● VKHB 2067 ● VKHB 2294 ● VKHB 2068 ● VKHB 2182 ● VKHB 2046 ● VKHB 2047 ● VKHB 2046 ● VKHB 2047 	33209/Q 32305 J2 33210/Q 33207/Q 33015/Q 33013/Q 33015/Q 33013/Q	VKS 6235 VKS 6237 VKS 6236 VKS 6237 VKS 6236	65) 66)	
S 150 (VF6 JK-SC, VF6 JN-1E), S150/180 (VF6 40-ACF/ACE)	<ul style="list-style-type: none"> ● E 400 ● E 401 ● E 402 ● E 5A ● E 5A ○ 1140 ○ 1141 ○ 1340 				<ul style="list-style-type: none"> ● VKHB 2061 ● VKHB 2065 ● VKHB 2068 ● VKHB 2182 ● VKHB 2067 ● VKHB 2182 ● VKHB 2051 ● VKHB 2067 ● VKHB 2051 ● VKHB 2068 ● VKHB 2161 ● VKHB 2158 ● VKHB 2161 ● ● VKHB 2192 	33211/Q 33208/Q 33210/Q 33207/Q 33209/Q 33207/Q 33213/Q 33209/Q 33213/Q 33210/Q 32019 X/Q 33117/Q 32019 X/Q JF 9549/9510	VKS 6238 VKS 6175 VKS 6175 VKS 6201 VKS 6201 VKS 6201	52) 43)	





RENAULT (RVI) .../...

	<ul style="list-style-type: none"> ○ 1341 ○ 669 ○ 669 ○ 769 - 02 ○ 769 - 05 ○ 769 - 06 ○ 940 ○ 941 		<ul style="list-style-type: none"> ● VKHB 2158 33117/Q ● VKHB 2192 JF 9549/9510 ● VKHB 2194 33216/Q ● VKHB 2044 33014 ● VKHB 2045 33012/Q ● VKHB 2282 32015 X/Q ● VKHB 2199 32013 X/Q ● VKHB 2161 32019 X/Q ● VKHB 2169 32017 X/Q ● VKHB 2046 33015/Q ● VKHB 2047 33013/Q ● VKHB 2282 32015 X/Q ● VKHB 2199 32013 X/Q ● VKHB 2161 32019 X/Q ● VKHB 2169 32017 X/Q ● VKHB 2161 32019 X/Q 	<ul style="list-style-type: none"> VKS 6201 VKS 6237 61) 62) VKS 6201 VKS 6237 VKS 6236 VKS 6201 VKS 6201
S 170 4x4	<ul style="list-style-type: none"> ● E 408 - 05 ● SINPAR MD 3000 ● SINPAR MD 3000 ● SINPAR MD 4000 ● 3MRDIF-155/ 156/158/171/ 214/216/219 ● 3MRDIF-8274 ● 3MRDIS- 8500 F W ○ P 1021 K ○ P 821, P 1021 		<ul style="list-style-type: none"> ● VKHB 2061 33211/Q ● VKHB 2065 33208/Q ● VKHB 2046 33015/Q ● VKHB 2282 32015 X/Q ● VKHB 2044 33014 ● VKHB 2154 32014 X/Q ● VKHB 2170 32018 X/Q ● VKHB 2170 32018 X/Q ● VKHB 2282 32015 X/Q ● VKHB 2169 32017 X/Q ● VKHB 2169 32017 X/Q ● VKHB 2169 32017 X/Q ● VKHB 2169 32017 X/Q ● VKHB 2169 32017 X/Q ● VKHB 2169 32017 X/Q 	<ul style="list-style-type: none"> VKS 6239 82) 83) 41) 41) 41) 41) VKS 6234 41) VKS 6234
S 170/220 (VF6 JS)	<ul style="list-style-type: none"> ● 408 - 05 ○ P 1020 ○ P 1021 		<ul style="list-style-type: none"> ● VKHB 2061 33211/Q ● VKHB 2065 33208/Q ● ● ● 	<ul style="list-style-type: none"> VKS 6239 VKS 6234 22) VKS 6234
S 90/130/150 (VF6 JN)	<ul style="list-style-type: none"> ● 401 ○ 769 		<ul style="list-style-type: none"> ● VKHB 2068 33210/Q ● VKHB 2182 33207/Q ● VKHB 2046 33015/Q ● VKHB 2047 33013/Q 	<ul style="list-style-type: none"> VKS 6235 66) VKS 6237 VKS 6236



	○	SOMA 95			●	VKHB 2046 VKHB 2047	33015/Q 33013/Q	VKS 6237 VKS 6236	
S 210	●	E5A			●	VKHB 2051 VKHB 2067	33213/Q 33209/Q	VKS 6175	52)
	●	E5A			●	VKHB 2051 VKHB 2068	33213/Q 33210/Q	VKS 6175	43)
	○	1140			●	VKHB 2161	32019 X/Q		84)
	○	1140			●	VKHB 2161 VKHB 2158	32019 X/Q 33117/Q	VKS 6201	85)
	○	1141			●	VKHB 2161	32019 X/Q	VKS 6201	
	○	1340			●	VKHB 2192 VKHB 2158	JF 9549/9510 33117/Q	VKS 6201	
	○	1341			●	VKHB 2192 VKHB 2194	JF 9549/9510 33216/Q	VKS 6201	
	○	669-03			●	VKHB 2044 VKHB 2045	33014 33012/Q		86)
	○	669-03			●	VKHB 2282 VKHB 2199	32015 X/Q 32013 X/Q		87)
	○	669-05			●	VKHB 2282 VKHB 2199	32015 X/Q 32013 X/Q		
	○	769-02			●	VKHB 2161 VKHB 2169	32019 X/Q 32017 X/Q	VKS 6201	
	○	769-05			●	VKHB 2046 VKHB 2047	33015/Q 33013/Q	VKS 6237 VKS 6236	
	○	769-06			●	VKHB 2282 VKHB 2199	32015 X/Q 32013 X/Q		
	○	940			●	VKHB 2161 VKHB 2169	32019 X/Q 32017 X/Q	VKS 6201	
	○	941			●	VKHB 2161	32019 X/Q	VKS 6201	
SE 160/180 Maroc	●	E 400-04/14			●	VKHB 2061 VKHB 2065	33211/Q 33208/Q	VKS 6239	
	●	E 408-AA	VKBA 5342		●	VKHB 2066 VKHB 2068	33214/Q 33210/Q	VKS 6303	
	●	E 408- 05/13/15/ 24			●	VKHB 2061 VKHB 2065	33211/Q 33208/Q	VKS 6239	
	○	P 821-13/17			●	VKHB 2169 VKHB 2169	32017 X/Q 32017 X/Q		VKS 6234
	○	P 1021-03			●				VKS 6234
	○	P 1040 F			●	VKHB 2161 VKHB 2158	32019 X/Q 33117/Q	VKS 6201	
	○	P 1041 F			●	VKHB 2161	32019 X/Q	VKS 6201	
	○	P 1140 F			●	VKHB 2161 VKHB 2158	32019 X/Q 33117/Q	VKS 6201	
	○	P 1141 F			●	VKHB 2161	32019 X/Q	VKS 6201	















RENAULT (RVI)

.../...

SG 2	<ul style="list-style-type: none"> ● 79 ○ 362 - 16BR - 17 MR - 26BR 	<ul style="list-style-type: none"> ● ● ● ● 	<ul style="list-style-type: none"> ● VKHB 2020 ● VKHB 2294 ● VKHB 2017 ● VKHB 2296 	<ul style="list-style-type: none"> 32208 J2/Q 32305 J2 32210 J2/Q 30209 J2/Q 	
SG 3	<ul style="list-style-type: none"> ● 603 ○ 212-01 	<ul style="list-style-type: none"> ● ● ● ● 	<ul style="list-style-type: none"> ● VKHB 2020 ● VKHB 2294 ● VKHB 2296 	<ul style="list-style-type: none"> 32208 J2/Q 32305 J2 30209 J2/Q 	<ul style="list-style-type: none"> 90) 90)
SG 4	<ul style="list-style-type: none"> ● 		<ul style="list-style-type: none"> ● ● 	<ul style="list-style-type: none"> ● VKHB 2067 ● VKHB 2294 	<ul style="list-style-type: none"> 33209/Q 32305 J2
TB 191	<ul style="list-style-type: none"> ● E4A ○ P 921 - B1/G 	<ul style="list-style-type: none"> ● ● ● 	<ul style="list-style-type: none"> ● VKHB 2173 ● VKHB 2056 	<ul style="list-style-type: none"> 33212/Q 33109/Q 	<ul style="list-style-type: none"> VKS 6202 VKS 6234
TB 231	<ul style="list-style-type: none"> ● E4A ○ P 921 - B1/G 	<ul style="list-style-type: none"> ● ● ● 	<ul style="list-style-type: none"> ● VKHB 2173 ● VKHB 2056 	<ul style="list-style-type: none"> 33212/Q 33109/Q 	<ul style="list-style-type: none"> VKS 6202 VKS 6234
TBH 260 (6x4)	<ul style="list-style-type: none"> ● E 6A ○ PMA/PR 1032 	<ul style="list-style-type: none"> ● ● ● 	<ul style="list-style-type: none"> ● VKHB 2066 ● VKHB 2067 ● VKHB 2186 ● VKHB 2187 	<ul style="list-style-type: none"> 33214/Q 33209/Q JHM 720249/ JHM 720210 64432/64708 	<ul style="list-style-type: none"> VKS 6175 73) VKS 6201
TBH 280 E (6x6)	<ul style="list-style-type: none"> ● PA 721 ○ PMA/P 1532 	<ul style="list-style-type: none"> ● ● ● 	<ul style="list-style-type: none"> ● VKHB 2186 ● VKHB 2187 	<ul style="list-style-type: none"> JHM 720249/ JHM 720210 64432/64708 	<ul style="list-style-type: none"> VKS 6234 VKS 6201
TBH 280 (6x4 D)	<ul style="list-style-type: none"> ● E 6A ● E 6A - 511 ○ PMA/PR 1032 	<ul style="list-style-type: none"> ● ● ● ● 	<ul style="list-style-type: none"> ● VKHB 2066 ● VKHB 2067 ● VKHB 2066 ● VKHB 2184 ● VKHB 2186 ● VKHB 2187 	<ul style="list-style-type: none"> 33214/Q 33209/Q 33214/Q T2ED 045 JHM 720249/ JHM 720210 64432/64708 	<ul style="list-style-type: none"> VKS 6175 73) VKS 6175 24) VKS 6201
TBH 280 (6x4)	<ul style="list-style-type: none"> ● E 6A 	<ul style="list-style-type: none"> ● 	<ul style="list-style-type: none"> ● VKHB 2066 ● VKHB 2067 	<ul style="list-style-type: none"> 33214/Q 33209/Q 	<ul style="list-style-type: none"> VKS 6175 73)

									
	<ul style="list-style-type: none"> ● E 6A ○ PMA/P 1532 				<ul style="list-style-type: none"> ● VKHB 2066 ● VKHB 2184 ● VKHB 2186 ● VKHB 2187 	33214/Q T2ED 045 JHM 720249/ JHM 720210 64432/64708	VKS 6175 24) VKS 6201		
TBH 280 (6x6)	<ul style="list-style-type: none"> ● PKBS 3 ○ PMA/PR 1032 			<ul style="list-style-type: none"> ● VKHB 2170 ● VKHB 2169 ● VKHB 2186 ● VKHB 2187 	32018 X/Q 32017 X/Q JHM 720249/ JHM 720210 64432/64708	VKS 6201			
TR 280/350	<ul style="list-style-type: none"> ● E 6A ○ P 1332 			<ul style="list-style-type: none"> ● VKHB 2066 ● VKHB 2067 ● VKHB 2186 ● VKHB 2187 	33214/Q 33209/Q JHM 720249/ JHM 720210 64432/64708	VKS 6175 VKS 6201			
TLM 280	<ul style="list-style-type: none"> ● E 6A - 51 ● E 6A - 51 ○ P 1532 			<ul style="list-style-type: none"> ● VKHB 2066 ● VKHB 2067 ● VKHB 2066 ● VKHB 2184 ● VKHB 2186 ● VKHB 2187 	33214/Q 33209/Q 33214/Q T2ED 045 JHM 720249/ JHM 720210 64432/64708	VKS 6175 23) VKS 6175 24) VKS 6201			
TR 305	<ul style="list-style-type: none"> ● E 6A ○ P 1332, P1332 B 			<ul style="list-style-type: none"> ● VKHB 2066 ● VKHB 2067 ● VKHB 2186 ● VKHB 2187 	33214/Q 33209/Q JHM 720249/ JHM 720210 64432/64708	VKS 6175 VKS 6201			
TRH 305 (6x4)	<ul style="list-style-type: none"> ● E 6A - 21 ○ PMA 1021, PMA 1321 ○ PMA 1032 B, PMA 1532 			<ul style="list-style-type: none"> ● VKHB 2066 ● VKHB 2067 ● VKHB 2185 ● VKHB 2042 ● VKHB 2186 ● VKHB 2187 	33214/Q 33209/Q 52375/52618 683/372 JHM 720249/ JHM 720210 64432/64708	VKS 6175 VKS 6201 VKS 6201			
TRH 350 6x4 TRH 350 TS	<ul style="list-style-type: none"> ● E 6A ○ PMA/PR 1032 B, PMA/P 1532 ○ PMA/PR/P 1021, PMA/PR 1321 			<ul style="list-style-type: none"> ● VKHB 2066 ● VKHB 2067 ● VKHB 2186 ● VKHB 2187 ● VKHB 2185 ● VKHB 2042 	33214/Q 33209/Q JHM 720249/ JHM 720210 64432/64708 52375/52618 683/372	VKS 6175 VKS 6201 VKS 6201			





RENAULT (RVI) .../...

TRM 2000

●	SOMA 3 MRDIPF-8250	●	VKHB 2243	JM 511946/ JM 511910/Q	88)
●	SOMA 3 MRDIPF-8250	●	VKHB 2154	32014 X/Q	
●	SOMA 3 MRDISP-8500	●	VKHB 2243	JM 511946/ JM 511910/Q	89)
●	SOMA 3 MRDISP-8500	●	VKHB 2154	32014 X/Q	
○	SOMA 3 MRPF- 8250	●	VKHB 2243	JM 511946/ JM 511910/Q	88)
○	SOMA 3 MRPF- 8250	●	VKHB 2154	32014 X/Q	
○	SOMA 3 MRSP- 8500	●	VKHB 2243	JM 511946/ JM 511910/Q	89)
○	SOMA 3 MRSP- 8500	●	VKHB 2154	32014 X/Q	

TRM 4000

●	HWT 1093	●	VKHB 2041	580/572/Q	
●	HWT 1093	●	VKHB 2208	567/563	
●	SOMA 12	●	VKHB 2282	32015 X/Q	

SCANIA

L 80, LB 80

●		●	VKHB 2001	32308 J2/Q	
○	R601, R640	●	VKHB 2026	32216 J2/Q	
○	R601, R640	●	VKHB 2033	32215 J2/Q	

L 81, LB 81

●	AM55	●	VKHB 2001	32308 J2/Q	1)
●	AM55	●	VKHB 2002	32311 J2	2)
●	AM55	●	VKHB 2001	32308 J2/Q	

LB 81











●	AM60	VKBA 5064	●	VKHB 2003	32312 J2/Q	VKS 6108
●	AM60	VKBA 5064	●	VKHB 2004	32309 J2/Q	

L 81, LB 81

○	R640	●	VKHB 2026	32216 J2/Q	3)
○	R640	●	VKHB 2033	32215 J2/Q	
○	R640	●	VKHB 2026	32216 J2/Q	VKS 6109
○	R640	●	VKHB 2028	33215/Q	4)
○	R640	●	VKHB 2026	32216 J2/Q	5)
○	R640	●	VKHB 2033	32215 J2/Q	

G 82, P 82, P 82 M, P 82 H

●	AM55	●	VKHB 2002	32311 J2	6)
●	AM55	●	VKHB 2001	32308 J2/Q	
●	AM55	●	VKHB 2002	32311 J2	VKS 6108
●	AM55	●	VKHB 2001	32308 J2/Q	7)
●	AM55	●	VKHB 2002	32311 J2	8)











									
	<ul style="list-style-type: none"> ● AM55 ● AM60 ○ AD80 ○ AD80 ○ AD90, ADA90 ○ AD90, ADA90 ○ AD90, ADA90 ○ AD90, ADA90 ○ AD90, ADA90 ○ AD90, ADA90 		VKBA 5064	VKA 4036	<ul style="list-style-type: none"> ● VKHB 2001 ● VKHB 2002 ● VKHB 2001 ● VKHB 2003 ● VKHB 2004 ● VKHB 2026 ● VKHB 2028 ● VKHB 2026 ● VKHB 2033 ● VKHB 2029 ● VKHB 2029 ● VKHB 2029 ● VKHB 2029 ● VKHB 2030 ● VKHB 2030 ● VKHB 2029 ● VKHB 2029 ● VKHB 2030 ● VKHB 2030 	<ul style="list-style-type: none"> 32308 J2/Q 32311 J2 32308 J2/Q 32312 J2/Q 32309 J2/Q 32216 J2/Q 33215/Q 32216 J2/Q 32215 J2/Q HM 218248/W/2A/210/2A/Q HM 218248/W/2A/210/2A/Q HM 218248/W/2A/210/2A/Q HM 218248/W/2A/210/2A/Q 32218 J2/Q 32218 J2/Q HM 218248/W/2A/210/2A/Q HM 218248/W/2A/210/2A/Q 32218 J2/Q 32218 J2/Q 	VKS 6108	9)	
	○ Trailing axle		VKA 4038	<ul style="list-style-type: none"> ● VKHB 2029 ● VKHB 2029 ● VKHB 2030 ● VKHB 2030 	<ul style="list-style-type: none"> HM 218248/W/2A/210/2A/Q HM 218248/W/2A/210/2A/Q 32218 J2/Q 32218 J2/Q 	VKS 6111	10),98)		
	○ Trailing axle		VKBA 5064	<ul style="list-style-type: none"> ● VKHB 2003 ● VKHB 2004 	<ul style="list-style-type: none"> 32312 J2/Q 32309 J2/Q 	VKS 6108			
	○ Trailing axle, ASA60		VKBA 5064	<ul style="list-style-type: none"> ● VKHB 2003 ● VKHB 2004 ● VKHB 2024 ● VKHB 2006 	<ul style="list-style-type: none"> 32312 J2/Q 32309 J2/Q T2ED 070/QCLNVB061 T2ED 055/QCLN 	VKS 6108			
	○ Trailing axle, ASA70								
	● AM55			<ul style="list-style-type: none"> ● VKHB 2002 ● VKHB 2001 	<ul style="list-style-type: none"> 32311 J2 32308 J2/Q 	VKS 6108	15)		
	● AM55			<ul style="list-style-type: none"> ● VKHB 2002 ● VKHB 2001 	<ul style="list-style-type: none"> 32311 J2 32308 J2/Q 	VKS 6108	16)		
	● AM60		VKBA 5064	<ul style="list-style-type: none"> ● VKHB 2003 ● VKHB 2004 	<ul style="list-style-type: none"> 32312 J2/Q 32309 J2/Q 	VKS 6108			
	○ AD80			<ul style="list-style-type: none"> ● VKHB 2026 ● VKHB 2028 	<ul style="list-style-type: none"> 32216 J2/Q 33215/Q 	VKS 6109	10)		





SCANIA .../...

	○ AD80			● ●	VKHB 2026 VKHB 2033	32216 J2/Q 32215 J2/Q	VKS 6109	5)
T 82 M (4x2), T82 H (4x2, 6x2)	○ AD90	VKBA 5067	VKA 4036	● ●	VKHB 2029 VKHB 2029	HM 218248/W/ 2A/210/2A/Q HM 218248/W/ 2A/210/2A/Q	VKS 6111 VKS 6105	10)
	○ AD90			● ●	VKHB 2030 VKHB 2030	32218 J2/Q 32218 J2/Q	VKS 6105	12)
T 82 M (4x2), T 82 H (4x2, 6x2)	○ AD90	VKBA 5067	VKA 4036	● ●	VKHB 2029 VKHB 2029	HM 218248/W/ 2A/210/2A/Q HM 218248/W/ 2A/210/2A/Q	VKS 6111 VKS 6105	13),98)
T 82 H (6x2)	○ Trailing axle, AS90	VKBA 5067	VKA 4036	● ●	VKHB 2029 VKHB 2029	HM 218248/W/ 2A/210/2A/Q HM 218248/W/ 2A/210/2A/Q	VKS 6111 VKS 6105	5),98)
	○ Trailing axle, AS90		VKA 4038	● ●	VKHB 2029 VKHB 2029	HM 218248/W/ 2A/210/2A/Q HM 218248/W/ 2A/210/2A/Q	VKS 6111	10),98)
L 85, LS 85	●			● ●	VKHB 2001	32308 J2/Q		
LB 85, LBS 85	●		VKBA 5064	● ●	VKHB 2003 VKHB 2004	32312 J2/Q 32309 J2/Q	VKS 6108	
L 85, LS 85, LB 85, LBS 85	○ R650, RD650, R651, R751			● ●	VKHB 2030 VKHB 2030	32218 J2/Q 32218 J2/Q	VKS 6105	
LS 85, LBS 85	○ Trailing axle			● ●	VKHB 2030 VKHB 2030	32218 J2/Q 32218 J2/Q		
L 86, LS 86	● AM55			● ●	VKHB 2001 VKHB 2002	32308 J2/Q 32311 J2		1)
	● AM55			● ●	VKHB 2001	32308 J2/Q		2)
L 86, LS 86, LB 86, LBS 86	● AM60	VKBA 5064		● ●	VKHB 2003 VKHB 2004	32312 J2/Q 32309 J2/Q	VKS 6108	
	○ R651, R653, R751, R752	VKBA 5067	VKA 4036	● ●	VKHB 2029 VKHB 2029	HM 218248/W/ 2A/210/2A/Q HM 218248/W/ 2A/210/2A/Q	VKS 6111 VKS 6105	18),98)
	○ R651, R653, R751, R752			● ●	VKHB 2030 VKHB 2030	32218 J2/Q 32218 J2/Q	VKS 6105	17)

										
		○ R651, R653, R751, R752			● ●	VKHB 2030 VKHB 2030	32218 J2/Q 32218 J2/Q	VKS 6105	5)	
LS 86, LBS 86		○ Trailing axle			● ●	VKHB 2030 VKHB 2030	32218 J2/Q 32218 J2/Q	VKS 6105	17)	
		○ Trailing axle			● ●	VKHB 2029 VKHB 2029	HM 218248/W/ 2A/210/2A/Q HM 218248/W/ 2A/210/2A/Q		18)	
		○ Trailing axle			● ●	VKHB 2030 VKHB 2030	32218 J2/Q 32218 J2/Q		5)	
G 92, P 92, P 92 M, P 92 H		● AM55			● ●	VKHB 2002 VKHB 2001	32311 J2 32308 J2/Q	VKS 6108	6)	
		● AM55			● ●	VKHB 2002 VKHB 2001	32311 J2 32308 J2/Q		7)	
		● AM55			● ●	VKHB 2002 VKHB 2001	32311 J2 32308 J2/Q		8)	
		● AM55			● ●	VKHB 2002 VKHB 2001	32311 J2 32308 J2/Q		VKS 6108	9)
		● AM60	VKBA 5064		● ●	VKHB 2003 VKHB 2004	32312 J2/Q 32309 J2/Q		VKS 6108	
		○ AD80			● ●	VKHB 2026 VKHB 2028	32216 J2/Q 33215/Q		VKS 6109	10)
		○ AD80			● ●	VKHB 2026 VKHB 2033	32216 J2/Q 32215 J2/Q		VKS 6109	5)
		○ AD90	VKBA 5067	VKA 4036	● ●	VKHB 2029 VKHB 2029	HM 218248/W/ 2A/210/2A/Q HM 218248/W/ 2A/210/2A/Q		VKS 6111	11),98)
		○ AD90			● ●	VKHB 2030 VKHB 2030	32218 J2/Q 32218 J2/Q		VKS 6105	14)
		○ AD90	VKBA 5067	VKA 4036	● ●	VKHB 2029 VKHB 2029	HM 218248/W/ 2A/210/2A/Q HM 218248/W/ 2A/210/2A/Q		VKS 6111	20),98)
		○ AD90, ADA90			● ●	VKHB 2030 VKHB 2030	32218 J2/Q 32218 J2/Q		VKS 6105	19)
		○ AD90, ADA90	VKBA 5067	VKA 4036	● ●	VKHB 2029 VKHB 2029	HM 218248/W/ 2A/210/2A/Q HM 218248/W/ 2A/210/2A/Q		VKS 6111	10),98)
G 92 H, P 92 H, R 92 H (6x2)		○ Trailing axle AS90			● ●	VKHB 2030 VKHB 2030	32218 J2/Q 32218 J2/Q		5)	
G 92 M, P 92 M (6x2)		○ Trailing axle	VKBA 5064		● ●	VKHB 2003 VKHB 2004	32312 J2/Q 32309 J2/Q	VKS 6108	5)	
G 92, P 92, P 92 M, P 92 H		○ Trailing axle, ASA60	VKBA 5064		● ●	VKHB 2003 VKHB 2004	32312 J2/Q 32309 J2/Q	VKS 6108	10)	





SCANIA .../...

	○ Trailing axle, ASA70			● VKHB 2024 ● VKHB 2006	T2ED 070/ QCLNVB061 T2ED 055/QCLN		10)
G 92, P 92 (6x2, 6x4)	○ Trailing axle, ASA60 ○ Trailing axle, ASA70 ○ Trailing axle, ARA55	VKBA 5064		● VKHB 2003 ● VKHB 2004 ● VKHB 2024 ● VKHB 2006 ● VKHB 2002 ● VKHB 2001	32312 J2/Q 32309 J2/Q T2ED 070/ QCLNVB061 T2ED 055/QCLN 32311 J2 32308 J2/Q	VKS 6108 VKS 6108	
P 92 H (6x2)	○ Trailing axle, AS90		VKA 4038	● VKHB 2029 ● VKHB 2029	HM 218248/W/ 2A/210/2A/Q HM 218248/W/ 2A/210/2A/Q	VKS 6111	10),98)
G 93, P 93, R 93, P 93 M, P 93 H, T 93	● AM56 ● AM56 ● AM61 ● AM70 ● AM70 ● AM70 ● AM800, AM820 ○ AD100 ○ AD100 ○ AD80 ○ AD80 ○ AD90, ADA90		VKA 4207 VKA 4207 VKA 4036	● VKHB 2228 ● VKHB 2004 ● VKHB 2003 ● VKHB 2004 ● VKHB 2003 ● VKHB 2004 ● VKHB 2024 ● VKHB 2006 ● VKHB 2024 ● VKHB 2006 ● VKHB 2024 ● VKHB 2006 ● ● ● VKHB 2032 ● VKHB 2032 ● VKHB 2032 ● VKHB 2032 ● VKHB 2026 ● VKHB 2028 ● VKHB 2026 ● VKHB 2033 ● VKHB 2029 ● VKHB 2029	T2EE 060/Q 32309 J2/Q 32312 J2/Q 32309 J2/Q 32312 J2/Q 32309 J2/Q T2ED 070/ QCLNVB061 T2ED 055/QCLN T2ED 070/ QCLNVB061 T2ED 055/QCLN T2ED 070/ QCLNVB061 T2ED 055/QCLN HM 220149 A/ W/110/QV002 HM 220149 A/ W/110/QV002 HM 220149 A/ W/110/QV002 HM 220149 A/ W/110/QV002 32216 J2/Q 33215/Q 32216 J2/Q 32215 J2/Q HM 218248/W/ 2A/210/2A/Q HM 218248/W/ 2A/210/2A/Q	VKS 6284 VKS 6261 VKS 6261 VKS 6261 VKS 6261 VKS 6109 VKS 6109 VKS 6111 VKS 6105	10) 5) 21) 14) 35) 36) 22) 27) 10) 5) 22),98)



	○ AD90, ADA90	VKBA 5067	VKA 4036	● VKHB 2029	HM 218248/W/ 2A/210/2A/Q	VKS 6111	23),98)
				● VKHB 2029	HM 218248/W/ 2A/210/2A/Q	VKS 6105	
	○ AD90, ADA90			● VKHB 2030	32218 J2/Q	VKS 6111	24),98)
				● VKHB 2030	32218 J2/Q	VKS 6105	
	○ AD90, ADA90			● VKHB 2030	32218 J2/Q		25)
				● VKHB 2030	32218 J2/Q	VKS 6105	
	○ ARA56			● VKHB 2228	T2EE 060/Q	VKS 6284	26)
				● VKHB 2004	32309 J2/Q		
	○ Trailing axle			● VKHB 2030	32218 J2/Q		5)
				● VKHB 2030	32218 J2/Q		
	○ Trailing axle, AS90		VKA 4038	● VKHB 2029	HM 218248/W/ 2A/210/2A/Q	VKS 6111	
				● VKHB 2029	HM 218248/W/ 2A/210/2A/Q		
	○ Trailing axle, AS60	VKBA 5064		● VKHB 2003	32312 J2/Q	VKS 6108	
				● VKHB 2004	32309 J2/Q		
	○ Trailing axle, ASA70			● VKHB 2024	T2ED 070/ QCLNVB061		
				● VKHB 2006	T2ED 055/QCLN		
	○ Trailing axle, ASA80			● VKHB 2026	32216 J2/Q	VKS 6109	10)
				● VKHB 2028	33215/Q		
94D, 94L, 94C, 94G	● AM620	VKBA 5314		●			85)
				●			
	● AM620, AM920	VKBA 5314		●			86)
				●			
	● AM620, AM920, AMA860	VKBA 5314		●			87)
				●			
	● AM820D	VKBA 5314		●			99)
				●			
	● AM900	VKBA 5314		●			47)
				●			
	● AM920	VKBA 5314		●			89)
				●			
	● AM740, AMA740, AMA860	VKBA 5314		●			88)
				●			
	○ AD1100		VKA 4369	● VKHB 2029	HM 218248/W/ 2A/210/2A/Q	VKS 6111	10),98)
				● VKHB 2029	HM 218248/W/ 2A/210/2A/Q		
	○ AD1100			● VKHB 2029	HM 218248/W/ 2A/210/2A/Q	VKS 6372	108)
				● VKHB 2029	HM 218248/W/ 2A/210/2A/Q		
	○ AD1100P			● VKHB 2029	HM 218248/W/ 2A/210/2A/Q		103)
				● VKHB 2029	HM 218248/W/ 2A/210/2A/Q		
	○ ADA1100		VKA 4369	● VKHB 2029	HM 218248/W/ 2A/210/2A/Q	VKS 6111	98)
				● VKHB 2029	HM 218248/W/ 2A/210/2A/Q		















SCANIA .../...

○ ADA1100		● VKHB 2029	HM 218248/W/ 2A/210/2A/Q	VKS 6372	108)
		● VKHB 2029	HM 218248/W/ 2A/210/2A/Q		
○ AD1300, ADA1300	VKA 4369	● VKHB 2029	HM 218248/W/ 2A/210/2A/Q	VKS 6111	98)
		● VKHB 2029	HM 218248/W/ 2A/210/2A/Q		
○ AD1300, ADA1300		● VKHB 2029	HM 218248/W/ 2A/210/2A/Q	VKS 6372	108)
		● VKHB 2029	HM 218248/W/ 2A/210/2A/Q		
○ AD1500P, ADA1500P		● VKHB 2147	T2EE 100		101)
		● VKHB 2147	T2EE 100		
○ AS900	VKA 4038	● VKHB 2029	HM 218248/W/ 2A/210/2A/Q	VKS 6111	21),98)
		● VKHB 2029	HM 218248/W/ 2A/210/2A/Q		
○ AS900		● VKHB 2029	HM 218248/W/ 2A/210/2A/Q	VKS 6372	108)
		● VKHB 2029	HM 218248/W/ 2A/210/2A/Q		
○ ASA1000	VKA 4038	● VKHB 2029	HM 218248/W/ 2A/210/2A/Q	VKS 6111	10),98)
		● VKHB 2029	HM 218248/W/ 2A/210/2A/Q		
○ ASA1000		● VKHB 2029	HM 218248/W/ 2A/210/2A/Q	VKS 6372	108)
		● VKHB 2029	HM 218248/W/ 2A/210/2A/Q		
○ ASA1000D	VKA 4038	● VKHB 2029	HM 218248/W/ 2A/210/2A/Q	VKS 6111	98),99)
		● VKHB 2029	HM 218248/W/ 2A/210/2A/Q		
○ ASA1000D		● VKHB 2029	HM 218248/W/ 2A/210/2A/Q	VKS 6372	108)
		● VKHB 2029	HM 218248/W/ 2A/210/2A/Q		
○ AS1300	VKA 4038	● VKHB 2029	HM 218248/W/ 2A/210/2A/Q	VKS 6111	98)
		● VKHB 2029	HM 218248/W/ 2A/210/2A/Q		
○ AS1300		● VKHB 2029	HM 218248/W/ 2A/210/2A/Q	VKS 6372	108)
		● VKHB 2029	HM 218248/W/ 2A/210/2A/Q		

L 110, LS 110

●		●			
○ R650, RD650, R651, R751		● VKHB 2001	32308 J2/Q		
		● VKHB 2030	32218 J2/Q	VKS 6105	
		● VKHB 2030	32218 J2/Q		
○ RP750		● VKHB 2031	32219 J2		
		● VKHB 2031	32219 J2		











									
LS 110		<input type="radio"/> Trailing axle			● ●	VKHB 2030 VKHB 2030	32218 J2/Q 32218 J2/Q		
LT 110	●				● ●	VKHB 2001	32308 J2/Q		
		<input type="radio"/>			● ●	VKHB 2030 VKHB 2030	32218 J2/Q 32218 J2/Q	VKS 6105	
LB 110, LBS 110	●		VKBA 5064		● ●	VKHB 2003 VKHB 2004	32312 J2/Q 32309 J2/Q	VKS 6108	
		<input type="radio"/> R650, RD650, R651, R751			● ●	VKHB 2030 VKHB 2030	32218 J2/Q 32218 J2/Q	VKS 6105	
		<input type="radio"/> RP750			● ●	VKHB 2031 VKHB 2031	32219 J2 32219 J2		
LBS 110		<input type="radio"/> Trailing axle			● ●	VKHB 2030 VKHB 2030	32218 J2/Q 32218 J2/Q		
LBT 110	●		VKBA 5064		● ●	VKHB 2003 VKHB 2004	32312 J2/Q 32309 J2/Q	VKS 6108	
		<input type="radio"/>			● ●	VKHB 2030 VKHB 2030	32218 J2/Q 32218 J2/Q	VKS 6105	
L 111, LS 111, LT 111	● ● ●	AM55 AM55 AM60	VKBA 5064		● ● ● ●	VKHB 2001 VKHB 2002 VKHB 2001	32308 J2/Q 32311 J2 32308 J2/Q	VKS 6108	1) 2)
		<input type="radio"/> AD90			● ●	VKHB 2003 VKHB 2004	32312 J2/Q 32309 J2/Q	VKS 6108	17)
		<input type="radio"/> AD90	VKBA 5067	VKA 4036	● ●	VKHB 2030 VKHB 2030	32218 J2/Q 32218 J2/Q	VKS 6105	18),98)
		<input type="radio"/> AD90			● ●	VKHB 2029 VKHB 2029	HM 218248/W/ 2A/210/2A/Q HM 218248/W/ 2A/210/2A/Q	VKS 6111 VKS 6105	5)
L 111, LT 111		<input type="radio"/> AD90	VKBA 5067	VKA 4036	● ●	VKHB 2030 VKHB 2030	32218 J2/Q 32218 J2/Q	VKS 6105	
		<input type="radio"/> AD90			● ●	VKHB 2029 VKHB 2029	HM 218248/W/ 2A/210/2A/Q HM 218248/W/ 2A/210/2A/Q	VKS 6111 VKS 6105	11),98)
L 111, LS 111, LT 111		<input type="radio"/> AD95			● ●	VKHB 2031 VKHB 2031	32219 J2 32219 J2		29)
LT 111		<input type="radio"/> AD95			● ●	VKHB 2031 VKHB 2031	32219 J2 32219 J2	VKS 6105	28)





SCANIA .../...

L 111, LS 111, LT 111	○ AD100			● VKHB 2032 ● VKHB 2032	HM 220149 A/ W/110/QV002 HM 220149 A/ W/110/QV002		
LS 111	○ Trailing axle ○ Trailing axle ○ Trailing axle		VKA 4038	● VKHB 2030 ● VKHB 2030 ● VKHB 2029 ● VKHB 2029 ● VKHB 2030 ● VKHB 2030	32218 J2/Q 32218 J2/Q HM 218248/W/ 2A/210/2A/Q HM 218248/W/ 2A/210/2A/Q 32218 J2/Q 32218 J2/Q	VKS 6111	17) 18),98) 5)
LB 111, LBS 111, LBT 111	● AM60	VKBA 5064		● VKHB 2003 ● VKHB 2004	32312 J2/Q 32309 J2/Q	VKS 6108	
LBT 111 FB	○ AD80 ○ AD80 ○ AD80			● VKHB 2026 ● VKHB 2033 ● VKHB 2026 ● VKHB 2028 ● VKHB 2026 ● VKHB 2033	32216 J2/Q 32215 J2/Q 32216 J2/Q 33215/Q 32216 J2/Q 32215 J2/Q	VKS 6109	30) 31) 5)
LB 111, LBS 111, LBT 111 BB/FB	○ AD90 ○ AD90 ○ AD90	VKBA 5067	VKA 4036	● VKHB 2030 ● VKHB 2030 ● VKHB 2029 ● VKHB 2029 ● VKHB 2030 ● VKHB 2030	32218 J2/Q 32218 J2/Q HM 218248/W/ 2A/210/2A/Q HM 218248/W/ 2A/210/2A/Q 32218 J2/Q 32218 J2/Q	VKS 6105 VKS 6111 VKS 6105 VKS 6105	30) 31),98) 5)
LB 111, LBT 111 BB	○ AD90 ○ AD95	VKBA 5067	VKA 4036	● VKHB 2029 ● VKHB 2029 ● VKHB 2031 ● VKHB 2031	HM 218248/W/ 2A/210/2A/Q HM 218248/W/ 2A/210/2A/Q 32219 J2 32219 J2	VKS 6111 VKS 6105 VKS 6105	11),98) 28)
LB 111, LBS 111, LBT 111 BB	○ AD95 ○ AD100 ○ Trailing axle ○ Trailing axle		VKA 4038	● VKHB 2031 ● VKHB 2031 ● VKHB 2032 ● VKHB 2032 ● VKHB 2030 ● VKHB 2030 ● VKHB 2029 ● VKHB 2029	32219 J2 32219 J2 HM 220149 A/ W/110/QV002 HM 220149 A/ W/110/QV002 32218 J2/Q 32218 J2/Q HM 218248/W/ 2A/210/2A/Q HM 218248/W/ 2A/210/2A/Q	VKS 6111	29) 30) 31),98)











									
		○ Trailing axle			● ●	VKHB 2030 VKHB 2030	32218 J2/Q 32218 J2/Q		5)
G 112 M, P 112 M, R 112 M, P 112 H, P 112 E, R 112 H, R 112 E	●	AM55			● ●	VKHB 2002 VKHB 2001	32311 J2 32308 J2/Q		6)
	●	AM55			● ●	VKHB 2002 VKHB 2001	32311 J2 32308 J2/Q	VKS 6108	7)
	●	AM55			● ●	VKHB 2002 VKHB 2001	32311 J2 32308 J2/Q		8)
	●	AM55			● ●	VKHB 2002 VKHB 2001	32311 J2 32308 J2/Q	VKS 6108	9)
G 112, P 112, R 112	●	AM60	VKBA 5064		● ●	VKHB 2003 VKHB 2004	32312 J2/Q 32309 J2/Q	VKS 6108	
G 112 M, P 112 M, R 112 M	●	AM70			● ●	VKHB 2024 VKHB 2006	T2ED 070/ QCLNVB061 T2ED 055/QCLN		32)
	○	AD80			● ●	VKHB 2026 VKHB 2028	32216 J2/Q 33215/Q	VKS 6109	10)
	○	AD80			● ●	VKHB 2026 VKHB 2033	32216 J2/Q 32215 J2/Q	VKS 6109	5)
G 112, P 112, R 112	○	AD90, ADA90	VKBA 5067	VKA 4036	● ●	VKHB 2029 VKHB 2029	HM 218248/W/ 2A/210/2A/Q HM 218248/W/ 2A/210/2A/Q	VKS 6111 VKS 6105	10),98)
	○	AD90, ADA90			● ●	VKHB 2030 VKHB 2030	32218 J2/Q 32218 J2/Q	VKS 6105	12)
	○	AD90, ADA90	VKBA 5067	VKA 4036	● ●	VKHB 2029 VKHB 2029	HM 218248/W/ 2A/210/2A/Q HM 218248/W/ 2A/210/2A/Q	VKS 6111 VKS 6105	13),98)
	○	AD90, ADA90	VKBA 5067	VKA 4036	● ●	VKHB 2029 VKHB 2029	HM 218248/W/ 2A/210/2A/Q HM 218248/W/ 2A/210/2A/Q	VKS 6111 VKS 6105	11),98)
	○	AD90, ADA90			● ●	VKHB 2030 VKHB 2030	32218 J2/Q 32218 J2/Q	VKS 6105	14)
	○	AD100			● ●	VKHB 2032 VKHB 2032	HM 220149 A/ W/110/QV002 HM 220149 A/ W/110/QV002		
	○	ARA55			● ●	VKHB 2002 VKHB 2001	32311 J2 32308 J2/Q	VKS 6108	
	○	Trailing axle ASA60	VKBA 5064		● ●	VKHB 2003 VKHB 2004	32312 J2/Q 32309 J2/Q	VKS 6108	
	○	Trailing axle ASA70			● ●	VKHB 2024 VKHB 2006	T2ED 070/ QCLNVB061 T2ED 055/QCLN		





SCANIA .../...

P 112 M (6x2), R 112 M (6x2)	○ Trailing axle AS60	VKBA 5064		●	VKHB 2003 VKHB 2004	32312 J2/Q 32309 J2/Q	VKS 6108	
P 112 H (6x2), R 112 H (6x2)	○ Trailing axle, AS90		VKA 4038	●	VKHB 2029	HM 218248/W/ 2A/210/2A/Q	VKS 6111	10),98)
	○ Trailing axle AS90			●	VKHB 2029	HM 218248/W/ 2A/210/2A/Q		
				●	VKHB 2030 VKHB 2030	32218 J2/Q 32218 J2/Q		5)
T 112 M (4x2), T 112 H, T 112 E	● AM55			●	VKHB 2002 VKHB 2001	32311 J2 32308 J2/Q	VKS 6108	15) 16)
	● AM55			●	VKHB 2002 VKHB 2001	32311 J2 32308 J2/Q		8)
	● AM55			●	VKHB 2002 VKHB 2001	32311 J2 32308 J2/Q	VKS 6108	9)
	● AM55			●	VKHB 2002 VKHB 2001	32311 J2 32308 J2/Q		
T 112 (4x2, 6x2, 6x4)	● AM60	VKBA 5064		●	VKHB 2003 VKHB 2004	32312 J2/Q 32309 J2/Q	VKS 6108	
	● AM70			●	VKHB 2024 VKHB 2006	T2ED 070/ QCLNVB061 T2ED 055/QCLN		
T 112 M (4x2)	○ AD80			●	VKHB 2026 VKHB 2028	32216 J2/Q 33215/Q	VKS 6109	10)
	○ AD80			●	VKHB 2026 VKHB 2033	32216 J2/Q 32215 J2/Q	VKS 6109	5)
T 112 (4x2, 6x2, 6x4)	○ AD90	VKBA 5067	VKA 4036	●	VKHB 2029	HM 218248/W/ 2A/210/2A/Q	VKS 6111	10),98)
				●	VKHB 2029	HM 218248/W/ 2A/210/2A/Q	VKS 6105	
	○ AD90, ADA90	VKBA 5067	VKA 4036	●	VKHB 2029	HM 218248/W/ 2A/210/2A/Q	VKS 6111	11),98)
				●	VKHB 2029	HM 218248/W/ 2A/210/2A/Q	VKS 6105	
	○ AD90, ADA90			●	VKHB 2030 VKHB 2030	32218 J2/Q 32218 J2/Q	VKS 6105	14)
	○ AD90, ADA90			●	VKHB 2030 VKHB 2030	32218 J2/Q 32218 J2/Q	VKS 6105	19)
	○ AD90, ADA90	VKBA 5067	VKA 4036	●	VKHB 2029	HM 218248/W/ 2A/210/2A/Q	VKS 6111	20),98)
				●	VKHB 2029	HM 218248/W/ 2A/210/2A/Q	VKS 6105	
	○ AD100			●	VKHB 2032 VKHB 2032	HM 220149 A/ W/110/QV002 HM 220149 A/ W/110/QV002		

									
T 112 (6x2)	○	Trailing axle, AS90		VKA 4038	●	VKHB 2029	HM 218248/W/ 2A/210/2A/Q	VKS 6111	10),98)
	○	Trailing axle, AS90			●	VKHB 2029	HM 218248/W/ 2A/210/2A/Q		
	○	Trailing axle, AS90			●	VKHB 2030	32218 J2/Q		5)
	○	Trailing axle, AS90			●	VKHB 2030	32218 J2/Q		
P 113, R 113, T 113, P 113 H, P 113 E, R 113 H, P 113 M, R 113 M, K 113 E, R 113 M, T 113 H, T 113 E	●	AM56			●	VKHB 2228	T2EE 060/Q	VKS 6284	10)
	●	AM56		VKA 4207	●	VKHB 2004	32309 J2/Q		
	●	AM56			●	VKHB 2003	32312 J2/Q	VKS 6261	5)
	●	AM61		VKA 4207	●	VKHB 2004	32309 J2/Q		
	●	AM61			●	VKHB 2003	32312 J2/Q	VKS 6261	21)
	●	AM70			●	VKHB 2004	32309 J2/Q		
	●	AM70			●	VKHB 2024	T2ED 070/ QCLNVB061		32)
	○	AD80			●	VKHB 2006	T2ED 055/QCLN		
	○	AD80			●	VKHB 2026	32216 J2/Q	VKS 6109	10)
	○	AD80			●	VKHB 2028	33215/Q		
	○	AD90, ADA90			●	VKHB 2026	32216 J2/Q	VKS 6109	5)
	○	AD90, ADA90			●	VKHB 2033	32215 J2/Q		
	○	AD90, ADA90			●	VKHB 2030	32218 J2/Q	VKS 6111	24),98)
	○	AD90, ADA90			●	VKHB 2030	32218 J2/Q	VKS 6105	
	○	AD90, ADA90	VKBA 5067	VKA 4036	●	VKHB 2030	32218 J2/Q	VKS 6105	25)
	○	AD90, ADA90			●	VKHB 2030	32218 J2/Q		
	○	AD90, ADA90			●	VKHB 2029	HM 218248/W/ 2A/210/2A/Q	VKS 6111	33),98)
	○	AD90, ADA90			●	VKHB 2029	HM 218248/W/ 2A/210/2A/Q	VKS 6105	
	○	AD100			●	VKHB 2032	HM 220149 A/ W/110/QV002		34)
	○	AD100			●	VKHB 2032	HM 220149 A/ W/110/QV002		
	○	ARA56			●	VKHB 2228	T2EE 060/Q	VKS 6284	26)
	○	ARA56			●	VKHB 2004	32309 J2/Q		
P 113, R 113, T 113, P 113 H, P 113 E, R 113 H, P 113 M, R 113 M, K 113 E, R 113 M, T 113 H, T 113 E	○	ARA61		VKA 4207	●	VKHB 2003	32312 J2/Q	VKS 6261	26)
	○	Trailing axle, AS60	VKBA 5064		●	VKHB 2004	32309 J2/Q		
	○	Trailing axle, ASA70			●	VKHB 2003	32312 J2/Q	VKS 6108	10)
	○	Trailing axle, ASA70			●	VKHB 2004	32309 J2/Q		
	○	Trailing axle, ASA70			●	VKHB 2024	T2ED 070/ QCLNVB061		10)
	○	Trailing axle, ASA80			●	VKHB 2006	T2ED 055/QCLN		
	○	Trailing axle, ASA80			●	VKHB 2026	32216 J2/Q	VKS 6109	
	○	Trailing axle, ASA80			●	VKHB 2028	33215/Q		
	○	Trailing axle, AS90		VKA 4038	●	VKHB 2029	HM 218248/W/ 2A/210/2A/Q	VKS 6111	21),98)
	○	Trailing axle, AS90			●	VKHB 2029	HM 218248/W/ 2A/210/2A/Q		
114L, 114C, 114G	●	AM620	VKBA 5314		●				85)
	●	AM620, AM920	VKBA 5314		●				86)





SCANIA .../...

●	AM620, AM920, AMA860	VKBA 5314	●			87)
●	AM740, AMA740	VKBA 5314	●			88)
●	AM820D	VKBA 5314	●			99)
●	AM900	VKBA 5314	●			47)
●	AM920	VKBA 5314	●			89)
○	ADA	VKA 4369	●	VKHB 2029	HM 218248/W/ 2A/210/2A/Q	VKS 6111 98),99)
○	ADA		●	VKHB 2029	HM 218248/W/ 2A/210/2A/Q	VKS 6372 108)
○	ADA1000	VKA 4369	●	VKHB 2029	HM 218248/W/ 2A/210/2A/Q	VKS 6111 98,27)
○	ADA1000		●	VKHB 2029	HM 218248/W/ 2A/210/2A/Q	VKS 6372 108)
○	ADA1100	VKA 4369	●	VKHB 2029	HM 218248/W/ 2A/210/2A/Q	VKS 6111 98)
○	ADA1100		●	VKHB 2029	HM 218248/W/ 2A/210/2A/Q	VKS 6372 108)
○	AD1100P		●	VKHB 2029	HM 218248/W/ 2A/210/2A/Q	91)
○	AD1300, ADA1300	VKA 4369	●	VKHB 2029	HM 218248/W/ 2A/210/2A/Q	VKS 6111 98)
○	AD1300, ADA1300		●	VKHB 2029	HM 218248/W/ 2A/210/2A/Q	VKS 6372 108)
○	AD1500P, ADA1500P AD150 OP, ADA1500P		●	VKHB 2147	T2EE 100	104)
○	AD1500P, ADA1500P		●	VKHB 2147	T2EE 100	92)
○	AS900	VKA 4038	●	VKHB 2029	HM 218248/W/ 2A/210/2A/Q	VKS 6111 90),98)



		○ AS900			●	VKHB 2029	HM 218248/W/ 2A/210/2A/Q		
		○ AS900		VKA 4038	●	VKHB 2029	HM 218248/W/ 2A/210/2A/Q	VKS 6372	108)
		○ AS900			●	VKHB 2029	HM 218248/W/ 2A/210/2A/Q		
		○ AS900			●	VKHB 2029	HM 218248/W/ 2A/210/2A/Q	VKS 6111	95),98)
		○ AS900			●	VKHB 2029	HM 218248/W/ 2A/210/2A/Q	VKS 6372	108)
		○ ASA1000		VKA 4038	●	VKHB 2029	HM 218248/W/ 2A/210/2A/Q	VKS 6111	47),98)
		○ ASA1000			●	VKHB 2029	HM 218248/W/ 2A/210/2A/Q		
		○ ASA1000			●	VKHB 2029	HM 218248/W/ 2A/210/2A/Q	VKS 6372	108)
		○ ASA1000D		VKA 4038	●	VKHB 2029	HM 218248/W/ 2A/210/2A/Q	VKS 6111	98),99)
		○ ASA1000D			●	VKHB 2029	HM 218248/W/ 2A/210/2A/Q		
		○ ASA1000D			●	VKHB 2029	HM 218248/W/ 2A/210/2A/Q	VKS 6372	108)
		○ AS1300		VKA 4038	●	VKHB 2029	HM 218248/W/ 2A/210/2A/Q	VKS 6111	10), 98)
		○ AS1300			●	VKHB 2029	HM 218248/W/ 2A/210/2A/Q		
		○ AS1300			●	VKHB 2029	HM 218248/W/ 2A/210/2A/Q	VKS 6372	108)
		○ AS1300			●	VKHB 2029	HM 218248/W/ 2A/210/2A/Q		
124L, 124C, 124G	●	AM620	VKBA 5314		●				
	●	AM740, AM740D, AMA740, AMA740D	VKBA 5314		●				47)
	●	AM820D	VKBA 5314		●				99)
	●	AMA860, AMA860D	VKBA 5314		●				
	●	AM900	VKBA 5314		●				47)
	●	AM920	VKBA 5314		●				
	●	AMD900			●	VKHB 2305	XC 8640 CD/HM 220110		47)
					●	VKHB 2305	XC 8640 CD/HM 220110		



SCANIA .../...

○ ADA1100	VKA 4369	● VKHB 2029	HM 218248/W/ 2A/210/2A/Q	VKS 6111	27),98)
		● VKHB 2029	HM 218248/W/ 2A/210/2A/Q		
○ ADA1100		● VKHB 2029	HM 218248/W/ 2A/210/2A/Q	VKS 6372	108)
		● VKHB 2029	HM 218248/W/ 2A/210/2A/Q		
○ ADA1100	VKA 4369	● VKHB 2029	HM 218248/W/ 2A/210/2A/Q	VKS 6111	47),98)
		● VKHB 2029	HM 218248/W/ 2A/210/2A/Q		
○ ADA1100		● VKHB 2029	HM 218248/W/ 2A/210/2A/Q	VKS 6372	108)
		● VKHB 2029	HM 218248/W/ 2A/210/2A/Q		
○ AD1100P		● VKHB 2029	HM 218248/W/ 2A/210/2A/Q		91)
		● VKHB 2029	HM 218248/W/ 2A/210/2A/Q		
○ AD1300, ADA1300	VKA 4369	● VKHB 2029	HM 218248/W/ 2A/210/2A/Q	VKS 6111	47),98)
		● VKHB 2029	HM 218248/W/ 2A/210/2A/Q		
○ AD1300, ADA1300		● VKHB 2029	HM 218248/W/ 2A/210/2A/Q	VKS 6372	108)
		● VKHB 2029	HM 218248/W/ 2A/210/2A/Q		
○ AD1300, ADA1300	VKA 4369	● VKHB 2029	HM 218248/W/ 2A/210/2A/Q	VKS 6111	27),98)
		● VKHB 2029	HM 218248/W/ 2A/210/2A/Q		
○ AD1300, ADA1300		● VKHB 2029	HM 218248/W/ 2A/210/2A/Q	VKS 6372	108)
		● VKHB 2029	HM 218248/W/ 2A/210/2A/Q		
○ ADA1300D	VKA 4369	● VKHB 2029	HM 218248/W/ 2A/210/2A/Q	VKS 6111	98),99)
		● VKHB 2029	HM 218248/W/ 2A/210/2A/Q		
○ ADA1300D		● VKHB 2029	HM 218248/W/ 2A/210/2A/Q	VKS 6372	108)
		● VKHB 2029	HM 218248/W/ 2A/210/2A/Q		
○ AD1500P, ADA1500P		● VKHB 2147	T2EE 100		10),14), 92)
		● VKHB 2147	T2EE 100		
○ AS900	VKA 4038	● VKHB 2029	HM 218248/W/ 2A/210/2A/Q	VKS 6111	90),98)
		● VKHB 2029	HM 218248/W/ 2A/210/2A/Q		
○ AS900		● VKHB 2029	HM 218248/W/ 2A/210/2A/Q	VKS 6372	108)
		● VKHB 2029	HM 218248/W/ 2A/210/2A/Q		













	○ AS900		VKA 4038	● VKHB 2029	HM 218248/W/ 2A/210/2A/Q	VKS 6111	95),98)
	○ AS900			● VKHB 2029	HM 218248/W/ 2A/210/2A/Q	VKS 6372	108)
	○ AS1300		VKA 4038	● VKHB 2029	HM 218248/W/ 2A/210/2A/Q	VKS 6111	48),98)
	○ AS1300			● VKHB 2029	HM 218248/W/ 2A/210/2A/Q	VKS 6372	108)
	○ ASA1000		VKA 4038	● VKHB 2029	HM 218248/W/ 2A/210/2A/Q	VKS 6111	47),98)
	○ ASA1000			● VKHB 2029	HM 218248/W/ 2A/210/2A/Q	VKS 6372	108)
	○ ASA1000D		VKA 4038	● VKHB 2029	HM 218248/W/ 2A/210/2A/Q	VKS 6111	98),107)
	○ ASA1000D			● VKHB 2029	HM 218248/W/ 2A/210/2A/Q	VKS 6372	108)
	○ ASA80			● VKHB 2026	32216 J2/Q	VKS 6109	90)
				● VKHB 2028	33215/Q		
L 140, LS 140, LT 145	●		VKBA 5064	● VKHB 2003	32312 J2/Q	VKS 6108	
	○ R651, RPB652, RP750			● VKHB 2004	32309 J2/Q		
				● VKHB 2031	32219 J2		
				● VKHB 2031	32219 J2		
L 140, LS 140	○ RP751			● VKHB 2030	32218 J2/Q	VKS 6105	
				● VKHB 2030	32218 J2/Q		
LS 140	○ Trailing axle			● VKHB 2030	32218 J2/Q		
				● VKHB 2030	32218 J2/Q		
LB 140, LBS 140, LBT 140	●		VKBA 5064	● VKHB 2003	32312 J2/Q	VKS 6108	
	○ R651			● VKHB 2004	32309 J2/Q		
	○ R652, RB652, RBP652, R751, R752			● VKHB 2030	32218 J2/Q	VKS 6105	
				● VKHB 2030	32218 J2/Q		
				● VKHB 2030	32218 J2/Q		





SCANIA .../...

					●	VKHB 2030	32218 J2/Q	VKS 6105	
LB 140, LBS 140	○ RP750				● ●	VKHB 2031 VKHB 2031	32219 J2 32219 J2		
LBS 140	○ Trailing axle				● ●	VKHB 2030 VKHB 2030	32218 J2/Q 32218 J2/Q		
L 141, LS 141, LT 146	●		VKBA 5064		● ●	VKHB 2003 VKHB 2004	32312 J2/Q 32309 J2/Q	VKS 6108	
L 141, LS 141	○ AD90				● ●	VKHB 2030 VKHB 2030	32218 J2/Q 32218 J2/Q	VKS 6105	17)
	○ AD90		VKBA 5067	VKA 4036	● ●	VKHB 2029 VKHB 2029	HM 218248/W/ 2A/210/2A/Q HM 218248/W/ 2A/210/2A/Q	VKS 6111	18),98)
	○ AD90				● ●	VKHB 2030 VKHB 2030	32218 J2/Q 32218 J2/Q	VKS 6105	5)
L 141, LS 141, LT 146	○ AD95				● ●	VKHB 2031 VKHB 2031	32219 J2 32219 J2		
	○ AD100				● ●	VKHB 2032 VKHB 2032	HM 220149 A/ W/110/QV002 HM 220149 A/ W/110/QV002		
LS 141	○ Trailing axle				● ●	VKHB 2030 VKHB 2030	32218 J2/Q 32218 J2/Q	VKS 6111	17) 18),98)
	○ Trailing axle			VKA 4038	● ●	VKHB 2029 VKHB 2029	HM 218248/W/ 2A/210/2A/Q HM 218248/W/ 2A/210/2A/Q		
	○ Trailing axle				● ●	VKHB 2030 VKHB 2030	32218 J2/Q 32218 J2/Q		5)
LB 141, LBS 141, LBT 141	●		VKBA 5064		● ●	VKHB 2003 VKHB 2004	32312 J2/Q 32309 J2/Q	VKS 6108	
LBT 141 FB	○ AD80				● ●	VKHB 2026 VKHB 2033	32216 J2/Q 32215 J2/Q	VKS 6109	30) 31)
	○ AD80				● ●	VKHB 2026 VKHB 2028	32216 J2/Q 33215/Q		
	○ AD80				● ●	VKHB 2026 VKHB 2033	32216 J2/Q 32215 J2/Q		5)
LB 141, LBS 141, LBT 141 BB/FB	○ AD90				● ●	VKHB 2030 VKHB 2030	32218 J2/Q 32218 J2/Q	VKS 6105	30)
	○ AD90		VKBA 5067	VKA 4036	● ●	VKHB 2029	HM 218248/W/ 2A/210/2A/Q	VKS 6111	31),98)











									
		○ AD90			●	VKHB 2029	HM 218248/W/ 2A/210/2A/Q	VKS 6105	5)
					●	VKHB 2030	32218 J2/Q	VKS 6105	
LBT 141 BB		○ AD95			●	VKHB 2031	32219 J2	VKS 6105	28)
LB 141, LBS 141, LBT 141 BB		○ AD95			●	VKHB 2031	32219 J2	VKS 6105	
		○ AD100			●	VKHB 2032	HM 220149 A/ W/110/QV002		
					●	VKHB 2032	HM 220149 A/ W/110/QV002		
LBS 141		○ Trailing axle			●	VKHB 2030	32218 J2/Q	VKS 6111	30)
		○ Trailing axle	VKA 4038		●	VKHB 2030	32218 J2/Q		31),98)
		○ Trailing axle			●	VKHB 2029	HM 218248/W/ 2A/210/2A/Q		5)
					●	VKHB 2029	HM 218248/W/ 2A/210/2A/Q		
R 142 M (4x2), R 142 H, R 142 E	●	AM55			●	VKHB 2002	32311 J2	VKS 6108	6)
	●	AM55			●	VKHB 2001	32308 J2/Q		7)
	●	AM55			●	VKHB 2002	32311 J2	VKS 6108	8)
	●	AM55			●	VKHB 2001	32308 J2/Q		9)
R 142 (4x2, 6x2, 6x4)	●	AM60	VKBA 5064		●	VKHB 2003	32312 J2/Q	VKS 6108	
	●	AM70			●	VKHB 2004	32309 J2/Q		
					●	VKHB 2024	T2ED 070/ QCLNVB061		
					●	VKHB 2006	T2ED 055/QCLN		
R 142 M (6x4)	○	AD80			●	VKHB 2026	32216 J2/Q	VKS 6109	10)
	○	AD80			●	VKHB 2028	33215/Q		5)
					●	VKHB 2026	32216 J2/Q		
					●	VKHB 2033	32215 J2/Q		
R 142 (4x2, 6x2, 6x4)	○	AD90, ADA90	VKBA 5067	VKA 4036	●	VKHB 2029	HM 218248/W/ 2A/210/2A/Q	VKS 6111	10),98)
	○	AD90, ADA90	VKBA 5067	VKA 4036	●	VKHB 2029	HM 218248/W/ 2A/210/2A/Q		VKS 6105
	○	AD90, ADA90	VKBA 5067	VKA 4036	●	VKHB 2029	HM 218248/W/ 2A/210/2A/Q	VKS 6111	11),98)
	○	AD90, ADA90	VKBA 5067	VKA 4036	●	VKHB 2029	HM 218248/W/ 2A/210/2A/Q		VKS 6105
	○	AD90, ADA90	VKBA 5067	VKA 4036	●	VKHB 2030	32218 J2/Q		12)





SCANIA .../...

	<ul style="list-style-type: none"> ○ AD90, ADA90 ○ AD90, ADA90 ○ AD100 ○ ARA55 ○ Trailing axle, ASA60 ○ Trailing axle, ASA70 	<p>VKBA 5067</p> <p>VKA 4036</p> <p>VKBA 5064</p>	<ul style="list-style-type: none"> ● VKHB 2030 ● VKHB 2029 ● VKHB 2029 ● VKHB 2030 ● VKHB 2030 ● VKHB 2032 ● VKHB 2032 ● VKHB 2002 ● VKHB 2001 ● VKHB 2003 ● VKHB 2004 ● VKHB 2024 ● VKHB 2006 	<p>32218 J2/Q</p> <p>HM 218248/W/ 2A/210/2A/Q</p> <p>HM 218248/W/ 2A/210/2A/Q</p> <p>32218 J2/Q</p> <p>32218 J2/Q</p> <p>HM 220149 A/ W/110/QV002</p> <p>HM 220149 A/ W/110/QV002</p> <p>32311 J2</p> <p>32308 J2/Q</p> <p>32312 J2/Q</p> <p>32309 J2/Q</p> <p>T2ED 070/ QCLNVB061</p> <p>T2ED 055/QCLN</p>	<p>VKS 6105</p> <p>VKS 6111</p> <p>VKS 6105</p> <p>VKS 6105</p> <p>VKS 6108</p> <p>VKS 6108</p> <p>VKS 6108</p>	<p>13),98)</p> <p>14)</p> <p>5),98)</p> <p>10),98)</p> <p>10)</p> <p>6)</p> <p>7)</p> <p>8)</p> <p>9)</p> <p>VKS 6108</p> <p>VKS 6109</p> <p>VKS 6109</p>
R 142 (6x2)	○ Trailing axle	VKA 4038	<ul style="list-style-type: none"> ● VKHB 2029 ● VKHB 2029 	<p>HM 218248/W/ 2A/210/2A/Q</p> <p>HM 218248/W/ 2A/210/2A/Q</p>	VKS 6111	5),98)
R 142 H (6x2)	○ Trailing axle	VKA 4038	<ul style="list-style-type: none"> ● VKHB 2029 ● VKHB 2029 	<p>HM 218248/W/ 2A/210/2A/Q</p> <p>HM 218248/W/ 2A/210/2A/Q</p>	VKS 6111	10),98)
R 142 M (6x2)	○ Trailing axle	VKBA 5064	<ul style="list-style-type: none"> ● VKHB 2003 ● VKHB 2004 	<p>32312 J2/Q</p> <p>32309 J2/Q</p>	VKS 6108	10)
T 142	<ul style="list-style-type: none"> ● AM55 ● AM55 ● AM55 ● AM55 		<ul style="list-style-type: none"> ● VKHB 2002 ● VKHB 2001 ● VKHB 2002 ● VKHB 2001 ● VKHB 2002 ● VKHB 2001 ● VKHB 2002 ● VKHB 2001 	<p>32311 J2</p> <p>32308 J2/Q</p> <p>32311 J2</p> <p>32308 J2/Q</p> <p>32311 J2</p> <p>32308 J2/Q</p> <p>32311 J2</p> <p>32308 J2/Q</p>	VKS 6108	6)
T 142 (4x2, 6x2, 6x4), T 142 E	<ul style="list-style-type: none"> ● AM60 ● AM70 	VKBA 5064	<ul style="list-style-type: none"> ● VKHB 2003 ● VKHB 2004 ● VKHB 2024 ● VKHB 2006 	<p>32312 J2/Q</p> <p>32309 J2/Q</p> <p>T2ED 070/ QCLNVB061</p> <p>T2ED 055/QCLN</p>	VKS 6108	
T 142 M	<ul style="list-style-type: none"> ○ AD80 ○ AD80 		<ul style="list-style-type: none"> ● VKHB 2026 ● VKHB 2028 ● VKHB 2026 ● VKHB 2033 	<p>32216 J2/Q</p> <p>33215/Q</p> <p>32216 J2/Q</p> <p>32215 J2/Q</p>	VKS 6109	10)
					VKS 6109	5)

									
	○ AD90, ADA90	VKBA 5067	VKA 4036	● VKHB 2029 ● VKHB 2029	HM 218248/W/ 2A/210/2A/Q HM 218248/W/ 2A/210/2A/Q	VKS 6111 VKS 6105	10),98)		
	○ AD90, ADA90			● VKHB 2030 ● VKHB 2030	32218 J2/Q 32218 J2/Q	VKS 6105	12)		
	○ AD90, ADA90	VKBA 5067	VKA 4036	● VKHB 2029 ● VKHB 2029	HM 218248/W/ 2A/210/2A/Q HM 218248/W/ 2A/210/2A/Q	VKS 6111 VKS 6105	13),98)		
	○ AD90, ADA90			● VKHB 2030 ● VKHB 2030	32218 J2/Q 32218 J2/Q	VKS 6105	14)		
T 142 (6x4)	○ AD90, ADA90	VKBA 5067	VKA 4036	● VKHB 2029 ● VKHB 2029	HM 218248/W/ 2A/210/2A/Q HM 218248/W/ 2A/210/2A/Q	VKS 6111 VKS 6105	11),98)		
T 142 (4x2, 6x2, 6x4)	○ AD100			● VKHB 2032 ● VKHB 2032	HM 220149 A/ W/110/QV002 HM 220149 A/ W/110/QV002				
T 142 (6x2)	○ Trailing axle, AS90		VKA 4038	● VKHB 2029 ● VKHB 2029	HM 218248/W/ 2A/210/2A/Q HM 218248/W/ 2A/210/2A/Q	VKS 6111	98)		
R 143, R 143 E, R 143 H, R 143 M, T 143 H	● AM56 ● AM56		VKA 4207	● VKHB 2228 ● VKHB 2004 ● VKHB 2003 ● VKHB 2004	T2EE 060/Q 32309 J2/Q 32312 J2/Q 32309 J2/Q	VKS 6284 VKS 6261	10) 5)		
R 143, T 143	● AM61 ● AM61 ● AM70 ● AM70 ● AM70		VKA 4207 VKA 4207	● VKHB 2003 ● VKHB 2004 ● VKHB 2003 ● VKHB 2004 ● VKHB 2024 ● VKHB 2006 ● VKHB 2024 ● VKHB 2006 ● VKHB 2024 ● VKHB 2006	32312 J2/Q 32309 J2/Q 32312 J2/Q 32309 J2/Q T2ED 070/ QCLNVB061 T2ED 055/QCLN T2ED 070/ QCLNVB061 T2ED 055/QCLN T2ED 070/ QCLNVB061 T2ED 055/QCLN	VKS 6261 VKS 6261 VKS 6261	10) 5) 14) 35) 36)		
R 143	○ AD80 ○ AD80			● VKHB 2026 ● VKHB 2028 ● VKHB 2026 ● VKHB 2033	32216 J2/Q 33215/Q 32216 J2/Q 32215 J2/Q	VKS 6109 VKS 6109	10) 5)		
R 143, T 143	○ AD90, ADA90			● VKHB 2030 ● VKHB 2030	32218 J2/Q 32218 J2/Q	VKS 6111 VKS 6105	24),98)		





SCANIA .../...

○ AD90, ADA90			● VKHB 2030 32218 J2/Q					25)
			● VKHB 2030 32218 J2/Q			VKS 6105		
○ AD90, ADA90	VKBA 5067	VKA 4036	● VKHB 2029 HM 218248/W/2A/210/2A/Q			VKS 6111		33),98)
			● VKHB 2029 HM 218248/W/2A/210/2A/Q			VKS 6105		
○ AD100			● VKHB 2032 HM 220149 A/W/110/QV002					33)
			● VKHB 2032 HM 220149 A/W/110/QV002					
○ AD100			● VKHB 2032 HM 220149 A/W/110/QV002					37)
			● VKHB 2032 HM 220149 A/W/110/QV002					
○ AD100			● VKHB 2147 T2EE 100					38)
			● VKHB 2147 T2EE 100					
○ ARA56			● VKHB 2228 T2EE 060/Q			VKS 6284		
			● VKHB 2004 32309 J2/Q					
○ ARA61		VKA 4207	● VKHB 2003 32312 J2/Q			VKS 6261		
			● VKHB 2004 32309 J2/Q					
○ ASA70			● VKHB 2024 T2ED 070/QCLNVB061					35)
			● VKHB 2006 T2ED 055/QCLN					
○ ASA70			● VKHB 2024 T2ED 070/QCLNVB061			VKS 6261		36)
			● VKHB 2006 T2ED 055/QCLN					
○ Trailing axle, AS90		VKA 4038	● VKHB 2029 HM 218248/W/2A/210/2A/Q			VKS 6111		21),98)
			● VKHB 2029 HM 218248/W/2A/210/2A/Q					
○ Trailing axle, AS60	VKBA 5064		● VKHB 2003 32312 J2/Q			VKS 6108		10)
			● VKHB 2004 32309 J2/Q					
○ Trailing axle, ASA80			● VKHB 2026 32216 J2/Q			VKS 6109		10)
			● VKHB 2028 33215/Q					

144L, 144C, 144G

● AM620	VKBA 5314		●					
● AM740, AM740D, AMA740, AMA740D	VKBA 5314		●					47)
● AM820D	VKBA 5314		●					99)
● AMA860, AMA860D	VKBA 5314		●					
● AM900	VKBA 5314		●					47)
● AM920	VKBA 5314		●					
○ ADA1100		VKA 4369	● VKHB 2029 HM 218248/W/2A/210/2A/Q			VKS 6111		98),99)
			● VKHB 2029 HM 218248/W/2A/210/2A/Q					



○ ADA1100			● VKHB 2029	HM 218248/W/ 2A/210/2A/Q	VKS 6372	108)
			● VKHB 2029	HM 218248/W/ 2A/210/2A/Q		
○ ADA1100		VKA 4369	● VKHB 2029	HM 218248/W/ 2A/210/2A/Q	VKS 6111	98)
			● VKHB 2029	HM 218248/W/ 2A/210/2A/Q		
○ ADA1100			● VKHB 2029	HM 218248/W/ 2A/210/2A/Q	VKS 6372	108)
			● VKHB 2029	HM 218248/W/ 2A/210/2A/Q		
○ ADA1100		VKA 4369	● VKHB 2029	HM 218248/W/ 2A/210/2A/Q	VKS 6111	27),98)
			● VKHB 2029	HM 218248/W/ 2A/210/2A/Q		
○ ADA1100			● VKHB 2029	HM 218248/W/ 2A/210/2A/Q	VKS 6372	108)
			● VKHB 2029	HM 218248/W/ 2A/210/2A/Q		
○ AD1100P			● VKHB 2029	HM 218248/W/ 2A/210/2A/Q		5), 91), 103)
			● VKHB 2029	HM 218248/W/ 2A/210/2A/Q		
○ ADA1300D		VKA 4369	● VKHB 2029	HM 218248/W/ 2A/210/2A/Q	VKS 6111	98),99)
			● VKHB 2029	HM 218248/W/ 2A/210/2A/Q		
○ ADA1300D			● VKHB 2029	HM 218248/W/ 2A/210/2A/Q	VKS 6372	108)
			● VKHB 2029	HM 218248/W/ 2A/210/2A/Q		
○ AD1300, ADA1300		VKA 4369	● VKHB 2029	HM 218248/W/ 2A/210/2A/Q	VKS 6111	47),98)
			● VKHB 2029	HM 218248/W/ 2A/210/2A/Q		
○ AD1300, ADA1300			● VKHB 2029	HM 218248/W/ 2A/210/2A/Q	VKS 6372	108)
			● VKHB 2029	HM 218248/W/ 2A/210/2A/Q		
○ AD1300, ADA1300		VKA 4369	● VKHB 2029	HM 218248/W/ 2A/210/2A/Q	VKS 6111	27),98)
			● VKHB 2029	HM 218248/W/ 2A/210/2A/Q		
○ AD1300, ADA1300			● VKHB 2029	HM 218248/W/ 2A/210/2A/Q	VKS 6372	108)
			● VKHB 2029	HM 218248/W/ 2A/210/2A/Q		
○ AD1500P, ADA1500P			● VKHB 2147	T2EE 100		92)
			● VKHB 2147	T2EE 100		
○ AD1500P, ADA1500P			● VKHB 2147	T2EE 100		104)
			● VKHB 2147	T2EE 100		
○ AS900		VKA 4038	● VKHB 2029	HM 218248/W/ 2A/210/2A/Q	VKS 6111	98)















SCANIA .../...

	○ AS900			● VKHB 2029	HM 218248/W/ 2A/210/2A/Q		
	○ ASA1000	VKA 4038		● VKHB 2029	HM 218248/W/ 2A/210/2A/Q	VKS 6372	108)
	○ ASA1000			● VKHB 2029	HM 218248/W/ 2A/210/2A/Q		
	○ ASA1000	VKA 4038		● VKHB 2029	HM 218248/W/ 2A/210/2A/Q	VKS 6111	47),98)
	○ ASA1000			● VKHB 2029	HM 218248/W/ 2A/210/2A/Q		
	○ ASA1000	VKA 4038		● VKHB 2029	HM 218248/W/ 2A/210/2A/Q	VKS 6372	108)
	○ ASA1000			● VKHB 2029	HM 218248/W/ 2A/210/2A/Q		
	○ ASA1000	VKA 4038		● VKHB 2029	HM 218248/W/ 2A/210/2A/Q	VKS 6111	98),99)
	○ ASA1000			● VKHB 2029	HM 218248/W/ 2A/210/2A/Q		
	○ ASA1000	VKA 4038		● VKHB 2029	HM 218248/W/ 2A/210/2A/Q	VKS 6372	108)
	○ ASA1000			● VKHB 2029	HM 218248/W/ 2A/210/2A/Q		
	○ AS1300	VKA 4038		● VKHB 2029	HM 218248/W/ 2A/210/2A/Q	VKS 6111	10), 98)
	○ AS1300			● VKHB 2029	HM 218248/W/ 2A/210/2A/Q		
	○ AS1300			● VKHB 2029	HM 218248/W/ 2A/210/2A/Q	VKS 6372	108)
	○ AS1300			● VKHB 2029	HM 218248/W/ 2A/210/2A/Q		
	○ ASA70			● VKHB 2024	T2ED 070/ QCLNVB061	VKS 6261	90)
	○ ASA70			● VKHB 2006	T2ED 055/QCLN		
	○ ASA80			● VKHB 2026	32216 J2/Q	VKS 6109	90)
	○ ASA80			● VKHB 2028	33215/Q		

P, R serie	● AM/AMA	VKBA 5314		●			109)
	○ ADA 1100 D, ADA 1300 D			●			
	○ ADA 1100 D, ADA 1300 D			● VKHB 2029	HM 218248/W/ 2A/210/2A/Q	VKS 6372	111)
	○ ADA 1100 D, ADA 1300 D			● VKHB 2029	HM 218248/W/ 2A/210/2A/Q	VKS 6105	
	○ ASA 700 D	VKBA 5314		●			110)
	○ ASA 1000 D			●			
	○ ASA 1000 D			● VKHB 2029	HM 218248/W/ 2A/210/2A/Q		110)
	○ ASA 1000 D			● VKHB 2029	HM 218248/W/ 2A/210/2A/Q		
	○ ARA 760/820/ 900 D	VKBA 5314		●			110)

VOLKSWAGEN

LT 28, LT 31 (281-286)	●	VKBA 802		●			1)
------------------------	---	----------	--	---	--	--	----











										
			○	VKBA 1496	•	•				4)
			○	VKBA 1497	•	•				5)
LT 35 (291-296)	•			VKBA 802	•	•				1)
			○	VKBA 1496	•	•				7)
			○	VKBA 1497	•	•				8)
LT 28-46 II	•			VKBA 3434	•	•				19)
			○	VKBA 3435	•	•				20)
			○	VKBA 3475	•	•				21)
LT 40, LT 45 (291, 293, 295)	•			VKBA 802	•	•				10)
	•			VKBA 836	•	•				11)
	•			VKBA 802	•	•				9)
LT 40, LT 45 (292, 294, 296)	•			VKBA 802	•	•				13)
	•			VKBA 836	•	•				14)
	•			VKBA 836	•	•				15)
			○		•	•	VKHB 2060 32011 X/Q			15)
			○		•	•	VKHB 2017 32210 J2/Q			17)
					•	•	VKHB 2060 32011 X/Q			17)
					•	•	VKHB 2017 32210 J2/Q			17)
LT 50, LT 55	•			VKBA 836	•	•				18)
			○		•	•	VKHB 2060 32011 X/Q			18)
					•	•	VKHB 2017 32210 J2/Q			18)
Transporter II, 1.6	•			VKBA 519	•	•				22)
Transporter II, 1.7	•			VKBA 519	•	•				23)





VOLKSWAGEN .../...











Transporter II, 2.0	●		VKBA 519	●	●			24)
Transporter II, 1.6, 1.6 D, 1.6 TD, 1.7, 1.7 D	○		VKBA 910	●	●			25)
Transporter III, 1.6	●		VKBA 911	●	●			26)
Transporter III, 1.6 D, 1.6 TD, 1.9, 2.0	●		VKBA 911	●	●			27)
Transporter III, 1.6 D, 1.6 TD	●		VKBA 912	●	●			28)
Transporter III, 1.7 D	●		VKBA 912	●	●			29)
Transporter III, 1.9, 2.0	●		VKBA 912	●	●			30)
Transporter III, 2.1, 2.1 i	●		VKBA 912	●	●			31)
Syncro: Transporter III	○		VKBA 910	●	●			32)
Syncro: Transporter III, 1.9, 2.0, 2.1, 2.1 i	○		VKBA 910	●	●			33)
Transporter IV	●		VKBA 3406	●	●			34)
Syncro: Transporter IV	●		VKBA 3406	●	●			35)
Transporter IV	○		VKBA 3406	●	●			36)
Syncro: Transporter IV	○		VKBA 3406	●	●			37)
Transporter V	●		VKBA 3646	●	●			38)
4Motion: Transporter V	●		VKBA 3646	●	●			39)

									
Transporter V	○		VKBA 3646		•				40)
VOLVO									
F 84, F 85	•	FAT 5, 0 ORATS80 ○ RATS81			• • • •	VKHB 2001 VKHB 2040 VKHB 2041 VKHB 2040 VKHB 2041	32308 J2/Q 594/592 A/Q 580/572/Q 594/592 A/Q 580/572/Q	VKS 6298 VKS 6298	1)
N 84	○	RAEV 60, RATS 60 RATS80 RATS81			• • • •	VKHB 2040 VKHB 2041 VKHB 2040 VKHB 2041	594/592 A/Q 580/572/Q 594/592 A/Q 580/572/Q	VKS 6298 VKS 6298	1)
F 86, F 87	•	FAT 5, 0			• •	VKHB 2001	32308 J2/Q		2)
F 86, FB 86, F 87	•	FAT 6, 0	VKBA 5099		• •	VKHB 2013 VKHB 2014	6386/K-6320/Q 537/532 X/Q	VKS 6114	
F 86, F 87	○	BAT 10			• •	VKHB 2040 VKHB 2041	594/592 A/Q 580/572/Q	VKS 6298	
F 86, FB 86, F 87	○	BAT 11	VKBA 5101	VKA 4266	• •	VKHB 2042 VKHB 2043	683/372 663/653/Q	VKS 6135 VKS 6298	
FB 86	○	Trailing axle Trailing axle Trailing axle			• • • •	VKHB 2040 VKHB 2041 VKHB 2040 VKHB 2041 VKHB 2042 VKHB 2043	594/592 A/Q 580/572/Q 594/592 A/Q 580/572/Q 683/372 663/653/Q	VKS 6135	3) 4) 5)
N 86, NB 86	•	FAT 5, 0 FAT 6, 0			• • •	VKHB 2001 VKHB 2013 VKHB 2014	32308 J2/Q 6386/K-6320/Q 537/532 X/Q	VKS 6114	2)
N 86	○	BAT 10			• •	VKHB 2040 VKHB 2041	594/592 A/Q 580/572/Q	VKS 6298	



VOLVO .../...











N 86, NB 86	○ BAT 11	VKBA 5101	VKA 4266	●	VKHB 2042	683/372	VKS 6135	6)
	○ BAT 11			●	VKHB 2043	663/653/Q	VKS 6298	
				●	VKHB 2042	683/372		7)
				●	VKHB 2043	663/653/Q	VKS 6298	
N 86	○ Trailing axle			●	VKHB 2040	594/592 A/Q		
				●	VKHB 2041	580/572/Q		
F 88, FB 88, G 88	● FAT 6, 0	VKBA 5099		●	VKHB 2013	6386/K-6320/Q	VKS 6114	
	○	VKBA 5101	VKA 4266	●	VKHB 2014	537/532 X/Q		
	○			●	VKHB 2042	683/372	VKS 6135	8)
				●	VKHB 2043	663/653/Q	VKS 6298	
				●	VKHB 2031	32219 J2		9)
				●	VKHB 2031	32219 J2		
FB 88, G 88 (6x2)	○ Trailing axle			●	VKHB 2040	594/592 A/Q		
				●	VKHB 2041	580/572/Q		
N 88 (4x2), NB 88 (6x2)	● FAT 5, 0			●	VKHB 2001	32308 J2/Q		2)
	● FAT 6, 0			●	VKHB 2013	6386/K-6320/Q	VKS 6114	
				●	VKHB 2014	537/532 X/Q		
N 88, NB 88	○	VKBA 5101	VKA 4266	●	VKHB 2042	683/372	VKS 6135	10)
	○			●	VKHB 2043	663/653/Q	VKS 6298	
				●	VKHB 2031	32219 J2		9)
				●	VKHB 2031	32219 J2		
NB 88 (6x2)	○ Trailing axle			●	VKHB 2040	594/592 A/Q		11)
	○ Trailing axle		VKA 4026	●	VKHB 2041	580/572/Q		
				●	VKHB 2042	683/372	VKS 6135	12)
				●	VKHB 2043	663/653/Q		
F 89, G 89 (4x2, 6x2, 6x4)	●	VKBA 5099		●	VKHB 2013	6386/K-6320/Q	VKS 6114	
	○	VKBA 5101	VKA 4266	●	VKHB 2014	537/532 X/Q		
				●	VKHB 2042	683/372	VKS 6135	10)
				●	VKHB 2043	663/653/Q	VKS 6298	
F 89, G 89 (4x2, 6x2)	○			●	VKHB 2031	32219 J2		9)
				●	VKHB 2031	32219 J2		
F 89, G 89 (6x2)	○ Trailing axle			●	VKHB 2040	594/592 A/Q		13)
	○ Trailing axle			●	VKHB 2041	580/572/Q		
	○ Trailing axle			●	VKHB 2040	594/592 A/Q		14)
	○ Trailing axle			●	VKHB 2041	580/572/Q		
				●	VKHB 2042	683/372	VKS 6135	15)
				●	VKHB 2043	663/653/Q		
F 406, F 407, F 408	●			●	VKHB 2015	32209 J2/Q		16)

									
	•	○			•	•	VKHB 2016 32206 J2/Q		17)
		○			•	•	VKHB 2017 32210 J2/Q		
		○			•	•	VKHB 2018 32207 J2/Q	VKS 6142	18)
					•	•	VKHB 2044 33014		
					•	•	VKHB 2045 33012/Q		19)
					•	•	VKHB 2044 33014		
					•	•	VKHB 2045 33012/Q		
FL 4	•	○			•	•	VKHB 2182 33207/Q	VKS 6202	
		○			•	•	VKHB 2044 33014		
		○			•	•	VKHB 2045 33012/Q		
F 607, F 608, F 609, F 610	•	○			•	•	VKHB 2017 32210 J2/Q		
		○			•	•	VKHB 2018 32207 J2/Q	VKS 6142	20)
		○			•	•	VKHB 2046 33015/Q		
					•	•	VKHB 2047 33013/Q		21)
					•	•	VKHB 2046 33015/Q		
					•	•	VKHB 2047 33013/Q		
F 611	•				•	•	VKHB 2019 32211 J2/Q	VKS 6239	22)
	•				•	•	VKHB 2020 32208 J2/Q		
					•	•	VKHB 2021 JM207049-90N90	VKS 6239	23)
					•	•	VKHB 2020 32208 J2/Q		
F 612, F 613	•				•	•	VKHB 2019 32211 J2/Q	VKS 6239	24)
	•				•	•	VKHB 2020 32208 J2/Q		
					•	•	VKHB 2021 JM207049-90N90	VKS 6239	25)
					•	•	VKHB 2020 32208 J2/Q		
F 614	•				•	•	VKHB 2019 32211 J2/Q	VKS 6239	26)
	•				•	•	VKHB 2020 32208 J2/Q		
					•	•	VKHB 2021 JM207049-90N90	VKS 6239	27)
					•	•	VKHB 2020 32208 J2/Q		
F 611, F 612, F 613, F 614		○			•	•	VKHB 2048 33018/Q	VKS 6140	28)
		○			•	•	VKHB 2046 33015/Q		
					•	•	VKHB 2048 33018/Q	VKS 6139	29)
					•	•	VKHB 2046 33015/Q		
F 615, F 616, F 617	•				•	•	VKHB 2023 JM 205149/110/Q		30)
	•		VKBA 5099		•	•	VKHB 2013 6386/K-6320/Q	VKS 6114	31)
	•	FAT 6.5	VKBA 5124	VKA 4004	•	•	VKHB 2014 537/532 X/Q		
					•	•	VKHB 2024 T2ED 070/QCLNVB061	VKS 6134	32)
					•	•	VKHB 2036 39580/W/2/39520/2/Q		33)



VOLVO .../...

	○				●	VKHB 2041	580/572/Q		
	○	BAT 10.9			●	VKHB 2040	594/592 A/Q	VKS 6136	34)
					●	VKHB 2041	580/572/Q		
					●	VKHB 2040	594/592 A/Q	VKS 6136	32)
					●	VKHB 2041	580/572/Q		
FL 6 (Ch B166080-, FL608-FL612)	●	FAT 4.1			●			VKS 6202	
	●	FAT 4.7			●	VKHB 2182	33207/Q		144)
	●	FAT 4.7			●	VKHB 2065	33208/Q		145)
					●	VKHB 2065	33208/Q		
FL 6 (Ch B166080-, FL612 FL615)	●	FAT 5.0, FAT 5.6			●				35)
					●	VKHB 2065	33208/Q		
FL 6 (Ch B166080-, FL616-FL626)	●		VKBA 5124	VKA 4004	●	VKHB 2024	T2ED 070/ QCLNVB061	VKS 6134	
					●	VKHB 2036	39580/W/2/ 39520/2/Q		
	●		VKBA 5124	VKA 4004	●	VKHB 2024	T2ED 070/ QCLNVB061	VKS 6134	39)
					●	VKHB 2036	39580/W/2/ 39520/2/Q		
	●		VKBA 5124	VKA 4004	●	VKHB 2024	T2ED 070/ QCLNVB061	VKS 6134	46)
					●	VKHB 2036	39580/W/2/ 39520/2/Q		
FL 6 (Ch -B169139, FL616-FL626)	●		VKBA 5124	VKA 4004	●	VKHB 2024	T2ED 070/ QCLNVB061	VKS 6134	11)
					●	VKHB 2036	39580/W/2/ 39520/2/Q		
FL6 (Ch.B169140-, FL616-FL626)	●		VKBA 5124	VKA 4004	●	VKHB 2024	T2ED 070/ QCLNVB061	VKS 6134	39)
					●	VKHB 2036	39580/W/2/ 39520/2/Q		
FL 6 (Ch B 169140-B190331, 4x2, 6x2, 6x4)	○		VKBA 5101	VKA 4266	●	VKHB 2042	683/372	VKS 6135	
					●	VKHB 2043	663/653/Q	VKS 6298	
FL 6 (Ch B166080-, FL618-FL619)	○	BAT 10.9, BAT 11.2, BAT 13.0			●	VKHB 2040	594/592 A/Q	VKS 6136	141)
					●	VKHB 2041	580/572/Q		
FL 6 (Ch B166080-, FL608-FL612)	○				●	VKHB 2221	47678/47620/Q	VKS 6207	143)
					●	VKHB 2175	39590/39520/Q		
	○				●	VKHB 2221	47678/47620/Q	VKS 6207	159)
					●	VKHB 2175	39590/39520/Q		











									
FL 6 (Ch B166080-, FL612-FL615)	○				● ●	VKHB 2222	33115/Q	VKS 6139	140)
FL 6 (Ch B166080-, FL616-FL617)	○				● ●	VKHB 2040 VKHB 2041	594/592 A/Q 580/572/Q	VKS 6136	142)
FL 6 (Ch B166080-, FL616-FL626, 4x2)	○				● ●	VKHB 2040 VKHB 2041	594/592 A/Q 580/572/Q	VKS 6136	12)
FL 6 (Ch.-B169139, FL618-FL619, 4x2)	○				● ●	VKHB 2040 VKHB 2041	594/592 A/Q 580/572/Q	VKS 6136	142)
FL 6 (Ch B166080-)	○	Trailing axle			● ●	VKHB 2065	33208/Q		160)
FL 608-612	●	FAT 4.1			● ●	VKHB 2182	33207/Q	VKS 6202	35)
	●	FAT 4.7			● ●	VKHB 2182	33207/Q		
FL 608-611	○				● ●	VKHB 2221 VKHB 2175	47678/47620/Q 39590/39520/Q	VKS 6207	36)
FL 608-612	○				● ●	VKHB 2221 VKHB 2175	47678/47620/Q 39590/39520/Q	VKS 6207	150)
FL 608-615	○				● ●	VKHB 2065	33208/Q		151)
FL 612	●	FAT 4.1			● ●	VKHB 2182	33207/Q	VKS 6202	146)
	●	FAT 4.7			● ●	VKHB 2182	33207/Q		146)
FL 612-614	●	FAT 5.0, FAT 5.6			● ●	VKHB 2065	33208/Q		35)
FL 612-615	●				● ●	VKHB 2065	33208/Q		35)
FL 612-614	○				● ●	VKHB 2222	33115/Q	VKS 6139	35)
	○				● ●	VKHB 2048 VKHB 2222	33018/Q 33115/Q	VKS 6139	37)
	○				● ●	VKHB 2222	33115/Q	VKS 6139	38)
FL 616-617	●		VKBA 5124	VKA 4004	●	VKHB 2024	T2ED 070/ QCLNVB061	VKS 6134	





VOLVO .../...

					●	VKHB 2036	39580/W/2/ 39520/2/Q		
FL 616-619	●		VKBA 5124	VKA 4004	●	VKHB 2024	T2ED 070/ QCLNVB061	VKS 6134	39)
	●		VKBA 5124	VKA 4004	●	VKHB 2036	39580/W/2/ 39520/2/Q		
	○				●	VKHB 2024	T2ED 070/ QCLNVB061	VKS 6134	46)
	○				●	VKHB 2036	39580/W/2/ 39520/2/Q		
	○				●	VKHB 2040	594/592 A/Q	VKS 6136	40)
	○				●	VKHB 2041	580/572/Q		
	○				●	VKHB 2040	594/592 A/Q	VKS 6136	46)
	○				●	VKHB 2041	580/572/Q		
FL 616-617	○				●	VKHB 2040	594/592 A/Q	VKS 6136	
					●	VKHB 2041	580/572/Q		
FL 618-619	○	BAT 10.9, BAT 11.2			●	VKHB 2040	594/592 A/Q	VKS 6136	39)
	○	BAT 10.0, BAT 10.9			●	VKHB 2041	580/572/Q		
	○	BAT 11.5			●	VKHB 2040	594/592 A/Q	VKS 6136	40)
	○	BAT 11.5, BAT 13.0			●	VKHB 2041	580/572/Q		
	○	BAT 11.5, BAT 13.0			●	VKHB 2040	594/592 A/Q	VKS 6136	147)
	○	BAT 11.5, BAT 13.0			●	VKHB 2041	580/572/Q		
					●	VKHB 2042	683/372		148)
					●	VKHB 2043	663/653/Q		
					●	VKHB 2042	683/372		40)
					●	VKHB 2043	663/653/Q	VKS 6298	
FL 616-619	○	Trailing axle	VKBA 5124	VKA 4004	●	VKHB 2024	T2ED 070/ QCLNVB061	VKS 6134	149)
					●	VKHB 2036	39580/W/2/ 39520/2/Q		
F 7 (4x2, 6x2, 6x4, 8x2, 8x4)	●	FAT 6.5	VKBA 5099		●	VKHB 2013	6386/K-6320/Q	VKS 6114	41)
	●	FAT 6.5	VKBA 5124	VKA 4004	●	VKHB 2014	537/532 X/Q		
	●	FAT 6.5	VKBA 5124	VKA 4004	●	VKHB 2024	T2ED 070/ QCLNVB061	VKS 6134	42)
	●	FAT 6.5	VKBA 5099		●	VKHB 2036	39580/W/2/ 39520/2/Q		
	●	FAT 6.5	VKBA 5099		●	VKHB 2013	6386/K-6320/Q	VKS 6114	43)
	●	FAT 6.5	VKBA 5099		●	VKHB 2014	537/532 X/Q		
	●	FAT 6.5	VKBA 5099		●	VKHB 2013	6386/K-6320/Q		44)
	●	FAT 6.5	VKBA 5099		●	VKHB 2014	537/532 X/Q		
	●	FAT 6.5	VKBA 5124	VKA 4004	●	VKHB 2024	T2ED 070/ QCLNVB061	VKS 6134	45)
	●	FAT 6.5	VKBA 5124	VKA 4004	●	VKHB 2036	39580/W/2/ 39520/2/Q		











									
	●	FAT 7.5	VKBA 5124	VKA 4004	●	VKHB 2024 VKHB 2036	T2ED 070/ QCLNVB061 39580/W/2/ 39520/2/Q	VKS 6134	
F 7 (4X2, 6X2, 8X2, 6X4, 8X4)	○		VKBA 5101	VKA 4266	●	VKHB 2042 VKHB 2043	683/372 663/653/Q	VKS 6135 VKS 6298	11)
	○		VKBA 5101	VKA 4266	●	VKHB 2042 VKHB 2043	683/372 663/653/Q	VKS 6135 VKS 6298	46)
F 7 (6X2, 6X4, 8X2, 8X4)	○		VKBA 5101	VKA 4266	●	VKHB 2042 VKHB 2043	683/372 663/653/Q	VKS 6135 VKS 6298	
F 7 (4X2)	○		VKBA 5101	VKA 4266	●	VKHB 2042 VKHB 2043	683/372 663/653/Q	VKS 6135 VKS 6298	47)
F 7 (6x2)	○	Trailing axle			●	VKHB 2040 VKHB 2041	594/592 A/Q 580/572/Q		48)
	○	Trailing axle			●	VKHB 2042 VKHB 2043	683/372 663/653/Q	VKS 6135	49)
	○	Trailing axle			●	VKHB 2050 VKHB 2051	HM 215249/ HM 215210 33213/Q		50)
	○	Trailing axle	VKBA 5124	VKA 4004	●	VKHB 2024 VKHB 2036	T2ED 070/ QCLNVB061 39580/W/2/ 39520/2/Q	VKS 6134	51)
FL 7	●		VKBA 5124	VKA 4004	●	VKHB 2024 VKHB 2036	T2ED 070/ QCLNVB061 39580/W/2/ 39520/2/Q	VKS 6134	12)
	●		VKBA 5124	VKA 4004	●	VKHB 2024 VKHB 2036	T2ED 070/ QCLNVB061 39580/W/2/ 39520/2/Q	VKS 6134	52)
	●				●	VKHB 2042 VKHB 2043	683/372 663/653/Q	VKS 6134	53)
FL 7 (4x2, 6x2, 8x2, 6x4, 8x4)	○	RAEV 85B, CTEV 87	VKBA 5101	VKA 4266	●	VKHB 2042 VKHB 2043	683/372 663/653/Q	VKS 6135 VKS 6298	55)
	○	RAEV 85B, CTEV 87	VKBA 5101	VKA 4266	●	VKHB 2042 VKHB 2043	683/372 663/653/Q	VKS 6135 VKS 6298	56)
FL 7 (4x2, 6x2, 6x4)	○	RAN 371, RTN 372, RTN 371			●	VKHB 2053 VKHB 2029	BT1B 639417/Q HM 218248/W/ 2A/210/2A/Q	VKS 6132	9)
FL 7	○	Trailing axle		VKA 4026	●	VKHB 2042	683/372	VKS 6135	57)





VOLVO .../...

					●	VKHB 2043	663/653/Q		
FL 7 (4x2, 6x2, 6x4)	○	Trailing axle			●	VKHB 2042	683/372	VKS 6135	11)
					●	VKHB 2043	663/653/Q		
	○	Trailing axle			●	VKHB 2042	683/372	VKS 6135	12)
					●	VKHB 2043	663/653/Q	VKS 6298	
	○	Trailing axle			●	VKHB 2042	683/372	VKS 6135	57)
					●	VKHB 2043	663/653/Q	VKS 6298	
	○	Trailing axle	VKBA 5124	VKA 4004	●	VKHB 2024	T2ED 070/ QCLNVB061	VKS 6134	58)
					●	VKHB 2036	39580/W/2/ 39520/2/Q		
FL 7	○	Trailing axle	VKBA 5124	VKA 4004	●	VKHB 2024	T2ED 070/ QCLNVB061	VKS 6134	104)
					●	VKHB 2036	39580/W/2/ 39520/2/Q		
FL 7 (4x2, 6x2, 6x4)	○	Trailing axle			●	VKHB 2024	T2ED 070/ QCLNVB061	VKS 6135	59)
					●	VKHB 2036	39580/W/2/ 39520/2/Q		
FM7	●		VKBA 5285	VKA 4265	●	VKHB 2024	T2ED 070/ QCLNVB061	VKS 6134	11)
					●	VKHB 2036	39580/W/2/ 39520/2/Q		
	●		VKBA 5285	VKA 4265	●	VKHB 2024	T2ED 070/ QCLNVB061	VKS 6134	101)
					●	VKHB 2036	39580/W/2/ 39520/2/Q		
	○	RAN 371, CTN 372			●	VKHB 2053	BT1B 639417/Q	VKS 6132	
					●	VKHB 2029	HM 218248/W/ 2A/210/2A/Q		
	○	Trailing axle	VKBA 5285	VKA 4265	●	VKHB 2024	T2ED 070/ QCLNVB061	VKS 6134	104)
					●	VKHB 2036	39580/W/2/ 39520/2/Q		
FS 7	●		VKBA 5124	VKA 4004	●	VKHB 2024	T2ED 070/ QCLNVB061	VKS 6134	
					●	VKHB 2036	39580/W/2/ 39520/2/Q		
	○				●	VKHB 2040	594/592 A/Q	VKS 6136	35)
					●	VKHB 2041	580/572/Q		
	○				●	VKHB 2040	594/592 A/Q	VKS 6136	156)
					●	VKHB 2041	580/572/Q		
	○				●	VKHB 2042	683/372		157)
					●	VKHB 2043	663/653/Q		
	○				●	VKHB 2042	683/372		60)
					●	VKHB 2043	663/653/Q		
	○				●	VKHB 2040	594/592 A/Q	VKS 6136	158)











									
		<input type="radio"/> Trailing axle	VKBA 5124	VKA 4004	<ul style="list-style-type: none"> ● ● ● 	VKHB 2041 580/572/Q VKHB 2024 T2ED 070/ QCLNVB061 39580/W/2/ VKHB 2036 39520/2/Q		VKS 6134	
N 7 (4x2, 6x2, 6x4)		<ul style="list-style-type: none"> ● FAT 5.0 ● FAT 5.0 ● FAT 6.5 ● FAT 6, .5 ● FAT 7.5 	VKBA 5099	VKA 4004	<ul style="list-style-type: none"> ● ● ● ● ● 	VKHB 2001 32308 J2/Q VKHB 2001 32308 J2/Q VKHB 2013 6386/K-6320/Q VKHB 2014 537/532 X/Q VKHB 2024 T2ED 070/ QCLNVB061 39580/W/2/ VKHB 2036 39520/2/Q VKHB 2024 T2ED 070/ QCLNVB061 39580/W/2/ VKHB 2036 39520/2/Q		VKS 6114 46) VKS 6114 61) VKS 6134 62)	
N 7 (4x2, 6x2)		<input type="radio"/> BAT 10			<ul style="list-style-type: none"> ● ● 	VKHB 2040 594/592 A/Q VKHB 2041 580/572/Q		VKS 6135 VKS 6298	
N 7 (4x2, 6x2, 6x4)		<input type="radio"/> BAT 13	VKBA 5101	VKA 4266	<ul style="list-style-type: none"> ● ● 	VKHB 2042 683/372 VKHB 2043 663/653/Q		VKS 6135 VKS 6298	
N 7 (4x2, 6x2)		<input type="radio"/> RAEV 85B	VKBA 5101	VKA 4266	<ul style="list-style-type: none"> ● ● 	VKHB 2042 683/372 VKHB 2043 663/653/Q		VKS 6135 63) VKS 6298	
N 7 (6x2)		<input type="radio"/> Trailing axle <input type="radio"/> Trailing axle <input type="radio"/> Trailing axle			<ul style="list-style-type: none"> ● ● ● ● 	VKHB 2042 683/372 VKHB 2043 663/653/Q VKHB 2040 594/592 A/Q VKHB 2041 580/572/Q VKHB 2042 683/372 VKHB 2043 663/653/Q		VKS 6135 12) VKS 6135 64) VKS 6135 65)	
FM 9		<ul style="list-style-type: none"> ● <input type="radio"/> RAN 471, CTN 372, CTN 472 <input type="radio"/> Trailing axle 	VKBA 5285	VKA 4265	<ul style="list-style-type: none"> ● ● ● ● 	VKHB 2024 T2ED 070/ QCLNVB061 39580/W/2/ VKHB 2036 39520/2/Q VKHB 2053 BT1B 639417/Q VKHB 2029 HM 218248/W/ 2A/210/2A/Q VKHB 2024 T2ED 070/ QCLNVB061 39580/W/2/ VKHB 2036 39520/2/Q		VKS 6134 VKS 6132 VKS 6134	
F 10 (4x2, 6x2, 6x4)		<ul style="list-style-type: none"> ● FAT 6.5 ● FAT 6.5 	VKBA 5099	VKA 4004	<ul style="list-style-type: none"> ● ● 	VKHB 2013 6386/K-6320/Q VKHB 2014 537/532 X/Q VKHB 2024 T2ED 070/ QCLNVB061		VKS 6114 66) VKS 6134 67)	





VOLVO .../...

	●	FAT 7.5	VKBA 5124	VKA 4004	● ● ●	VKHB 2036 VKHB 2024 VKHB 2036	39580/W/2/ 39520/2/Q T2ED 070/ QCLNVB061 39580/W/2/ 39520/2/Q	VKS 6134	
F 10 (4x2, 6x2)	○		VKBA 5101	VKA 4266	● ●	VKHB 2042 VKHB 2043	683/372 663/653/Q	VKS 6135 VKS 6298	69)
F 10 (4x2, 6x2, 6x4)	○		VKBA 5101	VKA 4266	● ●	VKHB 2042 VKHB 2043	683/372 663/653/Q	VKS 6135 VKS 6298	68)
F 10 (4x2, 6x2)	○ ○ ○	RAN 71, RTN 71, RTN 72 RAN 81, RTN 80, RTN 87			● ● ● ●	VKHB 2042 VKHB 2053 VKHB 2029 VKHB 2031 VKHB 2031	683/372 BT1B 639417/Q HM 218248/W/ 2A/210/2A/Q 32219 J2 32219 J2	VKS 6135 VKS 6298 VKS 6132	70) 9) 9)
F 10 (6x2)	○ ○ ○ ○ ○ ○ ○ ○ ○	Trailing axle Trailing axle Trailing axle Trailing axle Trailing axle Trailing axle Trailing axle	VKBA 5124 VKBA 5101 VKBA 5124	VKA 4004 VKA 4266 VKA 4004	● ● ● ● ● ● ● ● ● ● ●	VKHB 2024 VKHB 2036 VKHB 2029 VKHB 2051 VKHB 2040 VKHB 2041 VKHB 2042 VKHB 2043 VKHB 2042 VKHB 2043 VKHB 2042 VKHB 2042 VKHB 2050 VKHB 2051 VKHB 2024 VKHB 2036	T2ED 070/ QCLNVB061 39580/W/2/ 39520/2/Q HM 218248/W/ 2A/210/2A/Q 33213/Q 594/592 A/Q 580/572/Q 683/372 663/653/Q 683/372 663/653/Q 683/372 663/653/Q 683/372 HM 215249/ HM 215210 33213/Q T2ED 070/ QCLNVB061 39580/W/2/ 39520/2/Q	VKS 6134	117) 118) 71) 72) 73) 74) 75) 76) 77)
FL 10	● ●		VKBA 5124 VKBA 5124	VKA 4004 VKA 4004	● ●	VKHB 2024 VKHB 2036 VKHB 2024	T2ED 070/ QCLNVB061 39580/W/2/ 39520/2/Q T2ED 070/ QCLNVB061	VKS 6134	12) 52)











									
	●				●	VKHB 2036	39580/W/2/ 39520/2/Q		
					●	VKHB 2042	683/372	VKS 6134	53)
					●	VKHB 2043	663/653/Q		
FL 10 (6X4, 8X4)	●				●	VKHB 2225	33217/Q		54)
					●	VKHB 2003	32312 J2/Q		
FL 10 (4x2, 6x2, 6x4, 8x4)	○		VKBA 5101	VKA 4266	●	VKHB 2042	683/372	VKS 6135	
					●	VKHB 2043	663/653/Q	VKS 6298	
FL 10 (4x2, 6x2, 8x2, 6x4, 8x4)	○	RAEV 85B, CTEV 87	VKBA 5101	VKA 4266	●	VKHB 2042	683/372	VKS 6135	55)
					●	VKHB 2043	663/653/Q	VKS 6298	
	○	RAEV 85B, CTEV 87	VKBA 5101	VKA 4266	●	VKHB 2042	683/372	VKS 6135	56)
					●	VKHB 2043	663/653/Q	VKS 6298	
FL 10 (4x2, 6x2, 6x4)	○	RAN 371, RTN 372, RTN 371			●	VKHB 2053	BT1B 639417/Q	VKS 6132	9)
					●	VKHB 2029	HM 218248/W/ 2A/210/2A/Q		
FL 10	○	Trailing axle		VKA 4026	●	VKHB 2042	683/372	VKS 6135	57)
					●	VKHB 2043	663/653/Q		
FL 10 (4x2, 6x2, 6x4)	○	Trailing axle			●	VKHB 2042	683/372	VKS 6135	11)
					●	VKHB 2043	663/653/Q		
	○	Trailing axle			●	VKHB 2042	683/372	VKS 6135	12)
					●	VKHB 2043	663/653/Q	VKS 6298	
	○	Trailing axle			●	VKHB 2042	683/372	VKS 6135	57)
					●	VKHB 2043	663/653/Q	VKS 6298	
	○	Trailing axle	VKBA 5124	VKA 4004	●	VKHB 2024	T2ED 070/ QCLNVB061	VKS 6134	58)
					●	VKHB 2036	39580/W/2/ 39520/2/Q		
FL 10	○	Trailing axle	VKBA 5124	VKA 4004	●	VKHB 2024	T2ED 070/ QCLNVB061	VKS 6134	104)
					●	VKHB 2036	39580/W/2/ 39520/2/Q		
FL 10 (4x2, 6x2, 6x4)	○	Trailing axle			●	VKHB 2024	T2ED 070/ QCLNVB061	VKS 6135	59)
					●	VKHB 2036	39580/W/2/ 39520/2/Q		
FM10	●		VKBA 5285	VKA 4265	●	VKHB 2024	T2ED 070/ QCLNVB061	VKS 6134	11)
					●	VKHB 2036	39580/W/2/ 39520/2/Q		





VOLVO .../...











	●		VKBA 5285	VKA 4265	●	VKHB 2024	T2ED 070/ QCLNVB061	VKS 6134	101)
		○ RAN 371, CTN 732, CTN 472			●	VKHB 2036	39580/W/2/ 39520/2/Q		
		○ Trailing axle	VKBA 5285	VKA 4265	●	VKHB 2053 VKHB 2029	BT1B 639417/Q HM 218248/W/ 2A/210/2A/Q	VKS 6132	9)
			VKBA 5285	VKA 4265	●	VKHB 2024	T2ED 070/ QCLNVB061	VKS 6134	104)
					●	VKHB 2036	39580/W/2/ 39520/2/Q		
FS 10	●		VKBA 5124	VKA 4004	●	VKHB 2024	T2ED 070/ QCLNVB061	VKS 6134	46)
					●	VKHB 2036	39580/W/2/ 39520/2/Q		
FS 10 (4x2, 6x4, 8x4)		○	VKBA 5101	VKA 4266	●	VKHB 2042	683/372	VKS 6135	69)
		○			●	VKHB 2043	663/653/Q	VKS 6298	
					●	VKHB 2053 VKHB 2029	BT1B 639417/Q HM 218248/W/ 2A/210/2A/Q	VKS 6132	78)
N 10 (4x2, 6x2, 6x4)	●	FAT 5.0			●	VKHB 2001	32308 J2/Q		
	●	FAT 6.5	VKBA 5099		●	VKHB 2013 VKHB 2014	6386/K-6320/Q 537/532 X/Q	VKS 6114	79)
	●	FAT 6.5	VKBA 5124	VKA 4004	●	VKHB 2024	T2ED 070/ QCLNVB061	VKS 6134	80)
					●	VKHB 2036	39580/W/2/ 39520/2/Q		
	●	FAT 7.5	VKBA 5124	VKA 4004	●	VKHB 2024	T2ED 070/ QCLNVB061	VKS 6134	
					●	VKHB 2036	39580/W/2/ 39520/2/Q		
	●		VKBA 5124	VKA 4004	●	VKHB 2024	T2ED 070/ QCLNVB061	VKS 6134	81)
					●	VKHB 2036	39580/W/2/ 39520/2/Q		
	●		VKBA 5124	VKA 4004	●	VKHB 2024	T2ED 070/ QCLNVB061	VKS 6134	82)
					●	VKHB 2036	39580/W/2/ 39520/2/Q		
N 10 (4x2, 6x2)		○ BAT 10			●	VKHB 2040	594/592 A/Q	VKS 6135	11)
					●	VKHB 2041	580/572/Q	VKS 6298	
N 10 (4x2, 6x2, 6x4)		○ BAT 13	VKBA 5101	VKA 4266	●	VKHB 2042	683/372	VKS 6135	11)
					●	VKHB 2043	663/653/Q	VKS 6298	
		○	VKBA 5101	VKA 4266	●	VKHB 2042	683/372	VKS 6135	69)
					●	VKHB 2043	663/653/Q	VKS 6298	
		○			●	VKHB 2042	683/372	VKS 6135	70)

										
		○	VKBA 5101	VKA 4266	●	VKHB 2042 VKHB 2043	683/372 663/653/Q	VKS 6298 VKS 6135 VKS 6298	83)	
		○	RAN 71, RTN 71, RTN 72		●	VKHB 2053 VKHB 2029	BT1B 639417/Q HM 218248/W/ 2A/210/2A/Q	VKS 6132	9)	
		○	RAN 81, RTN 80, RTN 82, RTN 87		●	VKHB 2031 VKHB 2031	32219 J2 32219 J2		9)	
N 10 (6x2)		○	Trailing axle	VKA 4026	●	VKHB 2042 VKHB 2043	683/372 663/653/Q	VKS 6135	46)	
		○	Trailing axle		●	VKHB 2040 VKHB 2041	594/592 A/Q 580/572/Q		84)	
		○	Trailing axle		●	VKHB 2042 VKHB 2043	683/372 663/653/Q	VKS 6135	85)	
		○	Trailing axle		●	VKHB 2042	683/372	VKS 6135	86)	
NL 10 S		●	FAT 6.5, FAT 6.7	VKBA 5124	VKA 4004	●	VKHB 2024	T2ED 070/ QCLNVB061	VKS 6134	11)
		●	FAT 7.5, FAT 8.0	VKBA 5124	VKA 4004	●	VKHB 2036	39580/W/2/ 39520/2/Q		
		●	FAT 9.0			●	VKHB 2024	T2ED 070/ QCLNVB061	VKS 6134	87)
		●				●	VKHB 2036	39580/W/2/ 39520/2/Q		
		●				●	VKHB 2225 VKHB 2003	33217/Q 32312 J2/Q		88)
NL 10 S (4x2, 6x2, 6x4)		○		VKBA 5101	VKA 4266	●	VKHB 2042 VKHB 2043	683/372 663/653/Q	VKS 6135 VKS 6298	11)
		○		VKBA 5101	VKA 4266	●	VKHB 2042 VKHB 2043	683/372 663/653/Q	VKS 6135 VKS 6298	69)
		○				●	VKHB 2042	683/372	VKS 6135 VKS 6298	70)
		○	Trailing axle	VKA 4026		●	VKHB 2042 VKHB 2043	683/372 663/653/Q	VKS 6135	11)
		○	Trailing axle	VKA 4026		●	VKHB 2042 VKHB 2043	683/372 663/653/Q	VKS 6135	46)
		○	Trailing axle			●	VKHB 2042	683/372	VKS 6135	89)
F 12 (4x2, 6x2, 6x4)		●	FAT 6.5	VKBA 5099		●	VKHB 2013 VKHB 2014	6386/K-6320/Q 537/532 X/Q	VKS 6114	90)
		●	FAT 6.5	VKBA 5124	VKA 4004	●	VKHB 2024	T2ED 070/ QCLNVB061	VKS 6134	91)
						●	VKHB 2036	39580/W/2/ 39520/2/Q		
F 12 (4x2, 6x2, 6x4, 8x2, 8x4)		●	FAT 7.5	VKBA 5124	VKA 4004	●	VKHB 2024	T2ED 070/ QCLNVB061	VKS 6134	92)



VOLVO .../...

	●	FAT 7.5	VKBA 5124	VKA 4004	● ● ●	VKHB 2036 VKHB 2024 VKHB 2036	39580/W/2/ 39520/2/Q T2ED 070/ QCLNVB061 39580/W/2/ 39520/2/Q	VKS 6134	93)
F 12 (4x2, 6x2, 6x4)	○ ○ ○ ○	RAN 81, RTN 80, RTN 87	VKBA 5101 VKBA 5101	VKA 4266 VKA 4266	● ● ● ● ● ●	VKHB 2042 VKHB 2043 VKHB 2042 VKHB 2042 VKHB 2043 VKHB 2031 VKHB 2031	683/372 663/653/Q 683/372 683/372 663/653/Q 32219 J2 32219 J2	VKS 6135 VKS 6298 VKS 6135 VKS 6298 VKS 6135 VKS 6298	69) 70) 94) 9)
F 12 (4x2, 6x2, 6x4, 8x2, 8x4)	○	RAN 71, RTN 71, RTN 72			● ●	VKHB 2053 VKHB 2029	BT1B 639417/Q HM 218248/W/ 2A/210/2A/Q	VKS 6132	9)
F 12 (6x2)	○ ○ ○ ○	Trailing axle Trailing axle Trailing axle Trailing axle	VKBA 5124	VKA 4004	● ● ● ● ● ●	VKHB 2029 VKHB 2051 VKHB 2024 VKHB 2036 VKHB 2040 VKHB 2041 VKHB 2050 VKHB 2051	HM 218248/W/ 2A/210/2A/Q 33213/Q T2ED 070/ QCLNVB061 39580/W/2/ 39520/2/Q 594/592 A/Q 580/572/Q HM 215249/HM 215210 33213/Q	VKS 6134	100) 51) 95) 99)
F 12 (6x2, 8x2)	○ ○ ○	Trailing axle Trailing axle Trailing axle		VKA 4026	● ● ● ●	VKHB 2042 VKHB 2043 VKHB 2042 VKHB 2043 VKHB 2042	683/372 663/653/Q 683/372 663/653/Q 683/372	VKS 6135 VKS 6135 VKS 6135	96) 97) 98)
FH 12	● ●		VKBA 5285 VKBA 5285	VKA 4265 VKA 4265	● ● ●	VKHB 2024 VKHB 2036 VKHB 2024 VKHB 2036	T2ED 070/ QCLNVB061 39580/W/2/ 39520/2/Q T2ED 070/ QCLNVB061 39580/W/2/ 39520/2/Q	VKS 6134 VKS 6134	101) 11)
FH 12 (4x2, 6x2, 6x4, 8x4)	○		VKBA 5101	VKA 4266	●	VKHB 2042	683/372	VKS 6135	11)

									
					●	VKHB 2043	663/653/Q	VKS 6298	
FH 12 (4x2, 6x2, 6x4)	○		VKBA 5101	VKA 4266	●	VKHB 2042 VKHB 2043	683/372 663/653/Q	VKS 6135 VKS 6298	102)
	○	CTN 372			●	VKHB 2053 VKHB 2029	BT1B 639417/Q HM 218248/W/ 2A/210/2A/Q	VKS 6132	103)
	○	RAN 471			●	VKHB 2053 VKHB 2029	BT1B 639417/Q HM 218248/W/ 2A/210/2A/Q	VKS 6132	9)
FH 12	○	Trailing axle	VKBA 5101	VKA 4266	●	VKHB 2042 VKHB 2043	683/372 663/653/Q	VKS 6135 VKS 6298	12)
FH 12 (4x2, 6x2, 6x4), Ch.-A276505, -B190367, -563621	○	Trailing axle	VKBA 5285	VKA 4265	●	VKHB 2024	T2ED 070/ QCLNVB061	VKS 6134	104)
	○	Trailing axle			●	VKHB 2036	39580/W/2/ 39520/2/Q	VKS 6135 VKS 6298	105)
FH 12 (4x2, 6x2, 6x4)	○	Trailing axle			●	VKHB 2042 VKHB 2043	683/372 663/653/Q	VKS 6135 VKS 6298	12)
FL 12	●		VKBA 5124	VKA 4004	●	VKHB 2024	T2ED 070/ QCLNVB061	VKS 6134	
					●	VKHB 2036	39580/W/2/ 39520/2/Q		
FL 12 (4x2, 6x2, 6x4, 8x4)	○		VKBA 5101	VKA 4266	●	VKHB 2042 VKHB 2043	683/372 663/653/Q	VKS 6135 VKS 6298	11)
	○		VKBA 5101	VKA 4266	●	VKHB 2042 VKHB 2043	683/372 663/653/Q	VKS 6135 VKS 6298	12)
	○	Trailing axle	VKBA 5124	VKA 4004	●	VKHB 2024	T2ED 070/ QCLNVB061	VKS 6134	
	○	Trailing axle			●	VKHB 2036	39580/W/2/ 39520/2/Q		
	○	Trailing axle			●	VKHB 2042 VKHB 2043	683/372 663/653/Q	VKS 6135 VKS 6298	
	○	Trailing axle			●	VKHB 2042 VKHB 2043	683/372 663/653/Q	VKS 6135 VKS 6298	12)
	○	Trailing axle	VKBA 5124	VKA 4004	●	VKHB 2024	T2ED 070/ QCLNVB061	VKS 6134	99)
					●	VKHB 2036	39580/W/2/ 39520/2/Q		
FLC	●				●	VKHB 2182	33207/Q	VKS 6202	
	○				●	VKHB 2044 VKHB 2045	33014 33012/Q		















VOLVO .../...











FM12	●		VKBA 5285	VKA 4265	●	VKHB 2024	T2ED 070/ QCLNVB061	VKS 6134	11)
					●	VKHB 2036	39580/W/2/ 39520/2/Q		
	●		VKBA 5285	VKA 4265	●	VKHB 2024	T2ED 070/ QCLNVB061	VKS 6134	101)
					●	VKHB 2036	39580/W/2/ 39520/2/Q		
	○	RAN 471, CTN 372, CTN 472			●	VKHB 2053	BT1B 639417/Q	VKS 6132	161)
				●	VKHB 2029	HM 218248/W/ 2A/210/2A/Q			
	○	Trailing axle	VKBA 5285	VKA 4265	●	VKHB 2024	T2ED 070/ QCLNVB061	VKS 6134	104)
				●	VKHB 2036	39580/W/2/ 39520/2/Q			











N 12 (4x2, 6x2, 6x4)	●	FAT 5.0			●	VKHB 2001	32308 J2/Q	VKS 6114	106)	
	●	FAT 6.5	VKBA 5099		●	VKHB 2013	6386/K-6320/Q			
	●	FAT 6.5	VKBA 5124	VKA 4004	●	VKHB 2014	537/532 X/Q	VKS 6134	107)	
					●	VKHB 2024	T2ED 070/ QCLNVB061			
	●	FAT 7.5, FAT 8.0	VKBA 5124	VKA 4004	●	VKHB 2036	39580/W/2/ 39520/2/Q	VKS 6134	101)	
					●	VKHB 2024	T2ED 070/ QCLNVB061			
		○			●	VKHB 2036	39580/W/2/ 39520/2/Q	VKS 6135 VKS 6298	69)	
		○		VKBA 5101	VKA 4266	●	VKHB 2042			683/372
		○	BAT 10			●	VKHB 2042	683/372	VKS 6135 VKS 6298	11)
		○	BAT 13	VKBA 5101	VKA 4266	●	VKHB 2043	663/653/Q		
		○	RAN 71, RTN 71, RTN 72			●	VKHB 2040	594/592 A/Q	VKS 6135 VKS 6298	11)
					●	VKHB 2041	580/572/Q			
	○	RAN 81, RTN 80, RTN 82, RTN 87			●	VKHB 2042	683/372	VKS 6135 VKS 6298	11)	
				●	VKHB 2043	663/653/Q				
					●	VKHB 2053	BT1B 639417/Q	VKS 6132	9)	
				●	VKHB 2029	HM 218248/W/ 2A/210/2A/Q				
					●	VKHB 2031	32219 J2	VKS 6135	111)	
				●	VKHB 2031	32219 J2				

N 12 (6x2)	○	Trailing axle			●	VKHB 2040	594/592 A/Q	VKS 6135	108)
					●	VKHB 2041	580/572/Q		
	○	Trailing axle		VKA 4026	●	VKHB 2042	683/372	VKS 6135	109)
					●	VKHB 2043	663/653/Q		
○	Trailing axle		VKA 4026	●	VKHB 2042	683/372	VKS 6135	110)	
				●	VKHB 2043	663/653/Q			
○	Trailing axle		VKA 4026	●	VKHB 2042	683/372	VKS 6135	111)	
				●	VKHB 2043	663/653/Q			

									
		○ Trailing axle			●	VKHB 2042	683/372	VKS 6135	112)
NH 12 (Ch.668771-)	●		VKBA 5285	VKA 4265	●	VKHB 2024	T2ED 070/ QCLNVB061 39580/W/2/ 39520/2/Q	VKS 6134	46), 89)
		○ CTN 372, RAN 471			●	VKHB 2036			
					●	VKHB 2053	BT1B 639417/Q		
					●	VKHB 2029	HM 218248/W/ 2A/210/2A/Q		
NL 12 S	●	FAT 6.5, FAT 6.7	VKBA 5124	VKA 4004	●	VKHB 2024	T2ED 070/ QCLNVB061 39580/W/2/ 39520/2/Q	VKS 6134	11)
					●	VKHB 2036			
	●	FAT 7.5, FAT 8.0	VKBA 5124	VKA 4004	●	VKHB 2024	T2ED 070/ QCLNVB061 39580/W/2/ 39520/2/Q	VKS 6134	113)
					●	VKHB 2036			
NL 12 S (4x2, 6x2, 6x4)	○		VKBA 5101	VKA 4266	●	VKHB 2042	683/372	VKS 6135	69)
	○				●	VKHB 2043	663/653/Q	VKS 6298	
	○		VKBA 5101	VKA 4266	●	VKHB 2042	683/372	VKS 6135	70)
	○	RTN 371, RTN 372, RAN 471			●	VKHB 2043	663/653/Q	VKS 6298	
	○	Trailing axle		VKA 4026	●	VKHB 2042	683/372	VKS 6135	11)
	○	Trailing axle		VKA 4026	●	VKHB 2043	663/653/Q	VKS 6135	46)
	○	Trailing axle			●	VKHB 2042	683/372	VKS 6135	89)
					●	VKHB 2053	BT1B 639417/Q	VKS 6132	9)
					●	VKHB 2029	HM 218248/W/ 2A/210/2A/Q		
F 16 (4x2, 6x2, 6x4)	●		VKBA 5124	VKA 4004	●	VKHB 2024	T2ED 070/ QCLNVB061 39580/W/2/ 39520/2/Q	VKS 6134	101)
					●	VKHB 2036			
	●	FAT 6.5, FAT 7.5, FAT 8.0	VKBA 5124	VKA 4004	●	VKHB 2024	T2ED 070/ QCLNVB061 39580/W/2/ 39520/2/Q	VKS 6134	
					●	VKHB 2036			
F 16 (4x2, 6x2)	○				●	VKHB 2042	683/372	VKS 6135	70)
					●	VKHB 2043	663/653/Q		
F 16 (4x2, 6x2, 6x4)	○				●	VKHB 2042	683/372	VKS 6135	69)
					●	VKHB 2043	663/653/Q		



									
	○				●	VKHB 2042 VKHB 2043	683/372 663/653/Q	VKS 6135	94)
	○	RTN 371, RTN 372, RAN 471			●	VKHB 2053 VKHB 2029	BT1B 639417/Q HM 218248/W/ 2A/210/2A/Q	VKS 6132	10)
F 16 (6x4)	○		VKBA 5101	VKA 4266	●	VKHB 2042 VKHB 2043	683/372 663/653/Q	VKS 6135 VKS 6298	69)
	○				●	VKHB 2042	683/372	VKS 6135 VKS 6298	70)
	○		VKBA 5101	VKA 4266	●	VKHB 2042 VKHB 2043	683/372 663/653/Q	VKS 6135 VKS 6298	94)
	○	Trailing axle		VKA 4026	●	VKHB 2042 VKHB 2043	683/372 663/653/Q	VKS 6135	114)
	○	Trailing axle			●	VKHB 2042	683/372	VKS 6135	115)
	○	Trailing axle	VKBA 5124	VKA 4004	●	VKHB 2024 VKHB 2036	T2ED 070/ QCLNVB061 39580/W/2/ 39520/2/Q	VKS 6134	116)
	○	Trailing axle			●	VKHB 2042 VKHB 2043	683/372 663/653/Q	VKS 6135	57)
	○	Trailing axle	VKBA 5124	VKA 4004	●	VKHB 2024 VKHB 2036	T2ED 070/ QCLNVB061 39580/W/2/ 39520/2/Q	VKS 6134	58)
FH 16	●		VKBA 5285	VKA 4265	●	VKHB 2024 VKHB 2036	T2ED 070/ QCLNVB061 39580/W/2/ 39520/2/Q	VKS 6134	101)
	●		VKBA 5285	VKA 4265	●	VKHB 2024 VKHB 2036	T2ED 070/ QCLNVB061 39580/W/2/ 39520/2/Q	VKS 6134	11)
	●		VKBA 5285	VKA 4265	●	VKHB 2024 VKHB 2036	T2ED 070/ QCLNVB061 39580/W/2/ 39520/2/Q	VKS 6134	40)
FH 16 (4x2, 6x2, 6x4, 8x4)	○		VKBA 5101	VKA 4266	●	VKHB 2042 VKHB 2043	683/372 663/653/Q	VKS 6135 VKS 6298	155)
FH 16 (4x2, 6x2, 6x4) Ch...-A291151	○				●	VKHB 2042 VKHB 2043	683/372 663/653/Q	VKS 6135 VKS 6298	102)
FH 16 (4x2, 6x2, 6x4)	○	CTN 372			●	VKHB 2053 VKHB 2029	BT1B 639417/Q HM 218248/W/ 2A/210/2A/Q	VKS 6132	103)
	○	RAN 471			●	VKHB 2053 VKHB 2029	BT1B 639417/Q HM 218248/W/ 2A/210/2A/Q	VKS 6132	9)

									
FH 16 (4x2, 6x2, 6x4) Ch. -A276505, -B190367, -563621	<input type="radio"/>	Trailing axle	VKBA 5285	VKA 4265	<ul style="list-style-type: none"> ● ● 	VKHB 2024 VKHB 2036	T2ED 070/ QCLNVB061 39580/W/2/ 39520/2/Q	VKS 6134	104)
FH 16 (Ch. .A291152-)	<input type="radio"/>	Trailing axle	VKBA 5285	VKA 4265	<ul style="list-style-type: none"> ● ● 	VKHB 2024 VKHB 2036	T2ED 070/ QCLNVB061 39580/W/2/ 39520/2/Q	VKS 6134	104)
FH 16 (4x2, 6x2, 6x4) Ch.. -A276505, -B190367, -563621	<input type="radio"/>	Trailing axle			<ul style="list-style-type: none"> ● ● 	VKHB 2042 VKHB 2043	683/372 663/653/Q	VKS 6135 VKS 6298	105)
FH 16 CHID. -A291151	<input type="radio"/>				<ul style="list-style-type: none"> ● ● 	VKHB 2042 VKHB 2043	683/372 663/653/Q	VKS 6135 VKS 6298	104)
FH 16 (4x2, 6x2, 6x4)	<input type="radio"/>	Trailing axle			<ul style="list-style-type: none"> ● ● 	VKHB 2042 VKHB 2043	683/372 663/653/Q	VKS 6135 VKS 6298	12)
FH 16 (4x2, 6x2, 6x4, 8x4)	<input type="radio"/>		VKBA 5101	VKA 4266	<ul style="list-style-type: none"> ● ● 	VKHB 2042 VKHB 2043	683/372 663/653/Q	VKS 6135 VKS 6298	11)



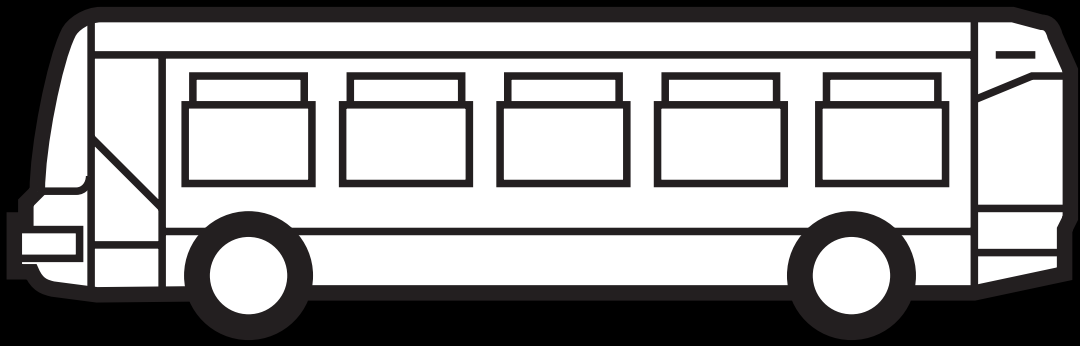



FIAT-IVECO

315.8-13, 315.8-17 Turbo, 315S.8-18, 316.8-13	256
370SE-27 Eurotech, 370SE-29 Eurotech, 370SE-35 Eurotech	256
370S.10-24, 370S.12-24, 370S.12-25L, 370S.12-30, 370S.12-35	256
370.10-24, 370.10-25, 370.12-24, 370.12-25, 370.12-25L, 370.12-30, 370.12-35	256
380.10-29 Euroclass, 380.12-29 Euroclass, 378.12-35 Euroclass, 380.12-38 Euroclass HD	256
470.10-20, 470.12-20	256
471.10-20 U-Effeuno, 471.12-20 U-Effeuno	256
480.10-21 Turbocity-U, 480.12-21 Turbocity-U, 480E.10-22 Turbocity-U, 480E.12-22 Turbocity-U, 480E.12-26 Turbocity-U	256
490.10-22 Turbocity-UR, 490.12-22 Turbocity-UR, 490E.10-22 Turbocity-UR, 490E.12-22 Turbocity-UR	257
490.18.29	257
570.10-20, 570.12-20	257
571.10-20 S-Effeuno, 571.12-20 S-Effeuno	257
580.10-21 Turbocity-S, 580.12-21 Turbocity-S, 580E.12-22 Turbocity-S	257
590E.12-22 Turbocity-SR	257
670.12-20	257
671.22-24 I-Effeuno	257
680.12-26 Turbocity-I, 2480.12, 3480.18-29 Turbocity-U, 4480-18	257

KÄSSBOHRER/SETRA

S 309 HD, S 312 HD, S 315 HD	258
S 312 HD	258
S 315 HD	258

MAN

292 (Type 880)	258
292/332/362H (Type 882)	258
EL 202, (Type A12)	258
NL 202 F (Type 898), NL 202 (Type 895)	258
NM-152, MIDI-BUS, (Type A05)	258
SG 242/292, 322, (Type 793)	259
SG 242/282H (Type 795)	259
SG 242/292, 322 (Type 793)	259
SG 242/292, 322, (Type 793)	259
SL 200, (Type 192)	259
SL 202, (Type 791)	259
SUE 240/280, (Type 789)	259
SUE 242, (Type 888)	259

MERCEDES-BENZ

O 301	260
O 303	260
O 305	261
O 307	261
O 309, 309 D	261
O 402	262
O 404	262
O 405	262
O 407	263
O 408	263
O 608 D, 609 D, 611 D, 614 D	263
O 814, 817	263

O 1114, 1117, 1120	264
O 1317	264
O 1417	264
O 1617, 1625, 1628	264
OH 1622, OH 1625, OH 1627, OH 1628, OH 1634	264

MERCEDES-BENZ "Baumuster"

730.013-014	264
730.015	264
730.035	264
730.042	264
730.047	265
730.049	265
730.053	265
730.054	265
730.060-062	265
730.502	265
730.503-.504	265
730.505	265
730.506	265
730.533	265
730.534	265
730.600, 730.602, -603, 730.630	266
730.732	266
730.733	266
730.830-832	266
739.003	266
739.133, 739.176	266
739.200-201, 739.203-204, 739.207, 739.209, 211	266
739.230-233	266
739.234	266
739.235-.236	266
739.238	266
739.240	266
739.241, 739.245	267
739.242	267
739.245	267
740.200, 740.230-233	267
741.001, 741.030-.031	267
741.200, 741.202-.203, 741.301-.304, 741.330-.337	267
741.560, 741.580	267
741.580, 742.420-.421, 742.436, 742.440	267
742.450	267
742.471, 742.481	267
744.601-602, 744.604, 744.630-632	267
744.701-702, 744.704, 744.706-707	267
744.731, 744.733-735	267
744.900, 744.904, 744.917-.918	268
744.920	268
744.950, 744.958, 744.960	268
745.139	268
745.200, 745.202, 745.207, 745.230	268
745.616	268
745.800-801, 745.807-809, 745.840-849	268
745.860-864	268
745.871-872, 745.874-877	268
745.990, 745.996-997	268
748.501	268
748.512-515, 748.517-524, 748.526	268
749.210-212	268

RENAULT (RVI)

AGORA citybus	268
ER 100-2	269
FRH	269



FRI	269
G 105, G 105 S, G 45, G 45 S	269
GX 187	269
GX 317	269
MEGABUS	269
PER 180	269
PG 60, PG 60 S	269
PGC 191, PGC 231	270
PR 10	270
PR 100	270
PR 100-2	270
PR 100-3, PR 112, PR 118	270
PR 12	270
PR 14	270
PR 180	270
PR 8C	271
TRACER	271

SCANIA

F 82 CL, S 82 CL	271
K 82	271
S 82 HR	271
B 86, BF 86	271
BR 86	272
K92CL, K92 CR	272
K 93 CRB	272
B 111	272
BF 111, BF 111-CKD	273
BR 112, N 112	273
F 112 CL, S 112 CL	273
K 112 CLB	274
N 111 AL	274
N 112 CLB	274
K 113 CLB	274
K 113 TLA, K 113 TLB	274
L 113 CLB	275
N 113 ALB	275
N 113 CLB, N 113 CRB	275
BR 116	276

VOLVO

B 10M, B 9M, B 10B, BLE, B 10L	276
B 10R	276
B 12	277
B 57, BB57	277
B 58	277
B 59	277
B 6	277
B 7	278
B 7R	278
B 7F, B 7FA	278



FIAT-IVECO

315.8-13, 315.8-17 Turbo, 315.8-18, 316.8-13



VKHB 2201 30309 J2/Q
VKHB 2063 32307 J2/Q
VKHB 2282 32015 X/Q
VKHB 2284 32214 J2/Q

370SE-27 Eurotech, 370SE-29 Eurotech, 370SE-35 Eurotech



VKHB 2013 6386/K-6320/Q
VKHB 2303 32310 TN9
VKHB 2210 32219 J2/
VB129
VKHB 2211 R 32217 J2/
VB128/
L 32217/Q

VKS 6215

370S.10-24, 370S.12-24, 370S.12-25L, 370S.12-30, 370S.12-35



VKHB 2013 6386/K-6320/Q
VKHB 2303 32310 TN9
VKHB 2212 32221 J2
VKHB 2211 R 32217 J2/
VB128/
L 32217/Q

VKS 6215
VKS 6225

370.10-24, 370.10-25, 370.12-24, 370.12-25, 370.12-25L, 370.12-30, 370.12-35



VKHB 2013 6386/K-6320/Q
VKHB 2303 32310 TN9
VKHB 2031 32219 J2
VKHB 2080 32217 J2/Q

VKS 6215

380.10-29 Euroclass, 380.12-29 Euroclass, 378.12-35 Euroclass, 380.12-38 Euroclass HD



VKHB 2013 6386/K-6320/Q
VKHB 2303 32310 TN9
VKHB 2210 32219 J2/
VB129
VKHB 2211 R 32217 J2/
VB128/
L 32217/Q

470.10-20, 470.12-20



VKHB 2283 30312 J2/Q
VKHB 2004 32309 J2/Q
VKHB 2162 33021/Q
VKHB 2225 33217/Q

471.10-20 U-Effeuno, 471.12-20 U-Effeuno



VKHB 2283 30312 J2/Q
VKHB 2004 32309 J2/Q
VKHB 2215 30221 J2
VKHB 2216 32024 X









VKS 6225

480.10-21 Turbocity-U, 480.12-21 Turbocity-U, 480E.10-22 Turbocity-U, 480E.12-22 Turbocity-U, 480E.12-26 Turbocity-U



VKHB 2286 HM 212049/
HM 212011
VKHB 2303 32310 TN9
VKHB 2215 30221 J2
VKHB 2216 32024 X

VKS 6215
VKS 6225

								
490.10-22 Turbocity-UR, 490.12-22 Turbocity-UR, 490E.10-22 Turbocity-UR, 490E.12-22 Turbocity-UR	●	○				<ul style="list-style-type: none"> ● VKHB 2286 ● VKHB 2303 ● VKHB 2285 ● VKHB 2285 	HM 212049/ HM 212011 32310 TN9 HM 220149/ HM 220110/Q HM 220149/ HM 220110/Q	VKS 6215 VKS 6180
490.18.29	●					<ul style="list-style-type: none"> ● VKHB 2286 ● VKHB 2303 	HM 212049/ HM 212011 32310 TN9	VKS 6215
570.10-20, 570.12-20	●	○				<ul style="list-style-type: none"> ● VKHB 2283 ● VKHB 2004 ● VKHB 2162 ● VKHB 2225 	30312 J2/Q 32309 J2/Q 33021/Q 33217/Q	
571.10-20 S-Effeuno, 571.12-20 S-Effeuno	●	○				<ul style="list-style-type: none"> ● VKHB 2283 ● VKHB 2004 ● VKHB 2215 ● VKHB 2216 	30312 J2/Q 32309 J2/Q 30221 J2 32024 X	VKS 6225
580.10-21 Turbocity-S, 580.12-21 Turbocity-S, 580E.12-22 Turbocity-S	●	○				<ul style="list-style-type: none"> ● VKHB 2286 ● VKHB 2303 ● VKHB 2215 ● VKHB 2216 	HM 212049/ HM 212011 32310 TN9 30221 J2 32024 X	VKS 6215 VKS 6225
590E.12-22 Turbocity-SR	●	○				<ul style="list-style-type: none"> ● VKHB 2286 ● VKHB 2303 ● VKHB 2285 ● VKHB 2285 	HM 212049/ HM 212011 32310 TN9 HM 220149/ HM 220110/Q HM 220149/ HM 220110/Q	VKS 6215 VKS 6180
670.12-20	●	○				<ul style="list-style-type: none"> ● VKHB 2283 ● VKHB 2004 ● VKHB 2162 ● VKHB 2225 	30312 J2/Q 32309 J2/Q 33021/Q 33217/Q	
671.22-24 I-Effeuno	●	○				<ul style="list-style-type: none"> ● VKHB 2283 ● VKHB 2004 ● VKHB 2215 ● VKHB 2216 	30312 J2/Q 32309 J2/Q 30221 J2 32024 X	VKS 6225
680.12-26 Turbocity-I, 2480.12, 3480.18-29 Turbocity-U, 4480-18	●	○				<ul style="list-style-type: none"> ● VKHB 2286 ● VKHB 2303 ● VKHB 2215 ● VKHB 2216 	HM 212049/ HM 212011 32310 TN9 30221 J2 32024 X	VKS 6215 VKS 6225



KÄSSBOHRER/SETRA

S 309 HD, S 312 HD, S 315 HD



VKA 4321



VKHB 2071
VKHB 2004

332330 B/Q
32309 J2/Q

VKS 6259
VKS 6263

S 312 HD

ZF



VKHB 2281
VKHB 2160

32022 X/Q
32021 X/Q

S 315 HD

ZF

Scania



VKHB 2281
VKHB 2160

32022 X/Q
32021 X/Q



VKHB 2281
VKHB 2160

32022 X/Q
32021 X/Q

MAN

292 (Type 880)



V7-75 SL

VKBA 5162



VKHB 2132
VKHB 2070

331933/Q
32310 J2/Q

VKS 6182



V7-70 SL

VKA 4125



VKHB 2132
VKHB 2068

331933/Q
33210/Q

VKS 6182

H07-1080



VKHB 2162
VKHB 2161

33021/Q
32019 X/Q

VKS 6183
VKS 6181

H09-1180



VKHB 2162
VKHB 2161

33021/Q
32019 X/Q

VKS 6183
VKS 6181

292/332/362H (Type 882)



V7-70 SL

VKA 4125



VKHB 2132
VKHB 2068

331933/Q
33210/Q

VKS 6182



V7-75 SL

VKBA 5162



VKHB 2132
VKHB 2070

331933/Q
32310 J2/Q

VKS 6182

H07-1080



VKHB 2162
VKHB 2161

33021/Q
32019 X/Q

VKS 6183
VKS 6181

H09-1180



VKHB 2162
VKHB 2161

33021/Q
32019 X/Q

VKS 6183
VKS 6181

EL 202, (Type A12)



V9-65 L

VKBA 5162



VKHB 2132
VKHB 2070

331933/Q
32310 J2/Q

VKS 6182

H0NL-1180



VKHB 2146
VKHB 2161

33021/QVB091
32019 X/Q

VKS 6183 1)
VKS 6181

H0NL-1180



VKHB 2146
VKHB 2161

33021/QVB091
32019 X/Q

VKS 6334 2)

NL 202 F (Type 898),
NL 202 (Type 895)



V9-65 L

VKBA 5162



VKHB 2132
VKHB 2070

331933/Q
32310 J2/Q

VKS 6182

H0NL- 1180



VKHB 2162
VKHB 2161

33021/Q
32019 X/Q

VKS 6183
VKS 6181

NM-152, MIDI-BUS,
(Type A05)



V9-65 L

VKBA 5162



VKHB 2132
VKHB 2070

331933/Q
32310 J2/Q

VKS 6182











H0NM-0780



VKHB 2172
VKHB 2082

331974 A/Q
33019/Q

VKS 6194

										
SG 242/292, 322, (Type 793)	●	V7-75 SL	VKBA 5162			●	VKHB 2132 VKHB 2070	331933/Q 32310 J2/Q	VKS 6182	
SG 242/282H (Type 795)	●	V7-70 SL		VKA 4125		●	VKHB 2132 VKHB 2068	331933/Q 33210/Q	VKS 6182	
	●	HN7-70 SL		VKA 4125		●	VKHB 2132 VKHB 2068	331933/Q 33210/Q	VKS 6182	
	○	H07-1080				●	VKHB 2162 VKHB 2161	33021/Q 32019 X/Q	VKS 6183 VKS 6181	
SG 242/292, 322 (Type 793)		○ H07-11120				●	VKHB 2146 VKHB 2161	33021/QVB091 32019 X/Q	VKS 6183 VKS 6181	1)
SG 242/292, 322, (Type 793)	●	V7-70 SL	VKBA 5162			●	VKHB 2132 VKHB 2070	331933/Q 32310 J2/Q	VKS 6182	13)
	●	V7-70 SL		VKA 4125		●	VKHB 2132 VKHB 2068	331933/Q 33210/Q	VKS 6182	12)
	○	H0M7-1100				●	VKHB 2146 VKHB 2161	33021/QVB091 32019 X/Q	VKS 6334	2)
	○	H0M7-1100				●	VKHB 2146 VKHB 2161	33021/QVB091 32019 X/Q	VKS 6183 VKS 6181	1)
	○	H07-11120				●	VKHB 2146 VKHB 2161	33021/QVB091 32019 X/Q	VKS 6334	2)
	○	H07-1080				●	VKHB 2146 VKHB 2161	33021/QVB091 32019 X/Q	VKS 6183 VKS 6181	
	○	H07-10/11120				●	VKHB 2146 VKHB 2161	33021/QVB091 32019 X/Q	VKS 6183 VKS 6181	
SL 200, (Type 192)	●	V7-70 SL		VKA 4125		●	VKHB 2132 VKHB 2068	331933/Q 33210/Q	VKS 6182	
	○	H07-1080				●	VKHB 2162 VKHB 2161	33021/Q 32019 X/Q	VKS 6183 VKS 6181	
SL 202, (Type 791)	●	V7-70 SL	VKBA 5162			●	VKHB 2132 VKHB 2070	331933/Q 32310 J2/Q	VKS 6182	13)
	●	V7-75 SL	VKBA 5162			●	VKHB 2132 VKHB 2070	331933/Q 32310 J2/Q	VKS 6182	
	●	V7-70 SL		VKA 4125		●	VKHB 2132 VKHB 2068	331933/Q 33210/Q	VKS 6182	12)
	○	H07-1080				●	VKHB 2162 VKHB 2161	33021/Q 32019 X/Q	VKS 6183 VKS 6181	
	○	H09-1180				●	VKHB 2162 VKHB 2161	33021/Q 32019 X/Q	VKS 6183 VKS 6181	
SUE 240/280, (Type 789)	●	V7-70 SL		VKA 4125		●	VKHB 2132 VKHB 2068	331933/Q 33210/Q	VKS 6182	
	○	H07-1080				●	VKHB 2162 VKHB 2161	33021/Q 32019 X/Q	VKS 6183 VKS 6181	
SUE 242, (Type 888)	●	V7-75 SL	VKBA 5162			●	VKHB 2132 VKHB 2070	331933/Q 32310 J2/Q	VKS 6182	



MAN .../...

● V7-70 SL	VKA 4125	● VKHB 2132	331933/Q	VKS 6182
○ H09-1180		● VKHB 2068	33210/Q	
○ H07-1080		● VKHB 2162	33021/Q	VKS 6183
		● VKHB 2161	32019 X/Q	VKS 6181
		● VKHB 2162	33021/Q	VKS 6183
		● VKHB 2161	32019 X/Q	VKS 6181

MERCEDES-BENZ

0 301	● VL 1/3-2.1		● VKHB 2054	2789/2720/ QCL7C	4)
	● VL 1/3-2.1	VKBA 5025	● VKHB 2055	1380/1328/Q	
	● VL 1/4-1.6		● VKHB 2056	33109/Q	VKS 6299 5)
	● VL 1/4-1.6		● VKHB 2057	33205/QVQ077	
	● VL 1/4-1.6		● VKHB 2058	32304 J2/Q	6)
	● VL 1/4-1.6	VKBA 5025	● VKHB 2018	32207 J2/Q	
	● VL 1/4-1.6	VKBA 5025	● VKHB 2054	2789/2720/ QCL7C	7)
	● VL 1/5-2.3, VL 1/ 6-2.3, VL 1/7-2.6	VKBA 5025	● VKHB 2055	1380/1328/Q	
	● VL 2/11 D-3.8		● VKHB 2056	33109/Q	VKS 6299 8)
	● VO 3/9 DL-5		● VKHB 2057	33205/QVQ077	
	○ HL 1/2-3.3		● VKHB 2056	33109/Q	VKS 6299
	○ HL 1/3-4.5, HL 2/ 5-4.5, HL 2/9-4.7		● VKHB 2057	33205/QVQ077	
			● VKHB 2061	33211/Q	VKS 6148
			● VKHB 2064	529656	
			● VKHB 2051	33213/Q	VKS 6157
			● VKHB 2065	33208/Q	
			● VKHB 2019	32211 J2/Q	VKS 6143 9)
			● VKHB 2017	32210 J2/Q	
			● VKHB 2075	33895/33822/Q	

0 303	● VL 1/3-2.1		● VKHB 2054	2789/2720/ QCL7C	4)
	● VL 1/3-2.1	VKBA 5025	● VKHB 2055	1380/1328/Q	
	● VL 1/4-1.6		● VKHB 2056	33109/Q	VKS 6299 5)
	● VL 1/4-1.6		● VKHB 2057	33205/QVQ077	
	● VL 1/4-1.6		● VKHB 2058	32304 J2/Q	6)
	● VL 1/4-1.6	VKBA 5025	● VKHB 2018	32207 J2/Q	
	● VL 1/4-1.6	VKBA 5025	● VKHB 2054	2789/2720/ QCL7C	7)
	● VL 1/5-2.3, VL 1/ 6-2.3, VL 1/7-2.6	VKBA 5025	● VKHB 2055	1380/1328/Q	
	● VL 2/11 D-3.8		● VKHB 2056	33109/Q	VKS 6299 8)
	● VO 3/9 DL-5		● VKHB 2057	33205/QVQ077	
			● VKHB 2056	33109/Q	VKS 6299
			● VKHB 2057	33205/QVQ077	
			● VKHB 2061	33211/Q	VKS 6148
			● VKHB 2064	529656	
			● VKHB 2051	33213/Q	VKS 6157
			● VKHB 2065	33208/Q	



	<ul style="list-style-type: none"> ● VO 3/10 DL-6 ● VO 3/10 DL-6 ● VO 3/9 DL-5, VO 3/9 L-5 ● VO 4/13 DL-7 ● VO 4/13 DL-7 ○ HL 1/2-3.3 ○ HL 1/3-4.5, HL 2/5-4.5, HL 2/9-4.7 ○ HO 4/01 DL-10 ○ HO 4/10 L-10, HO 4/10 DL-10, HO 5/8 L-10, HO 5/8 DL-10 ○ HO 4/18 L-7.7, HO 4/18 DL-7.7 	VKBA 5038	VKA 4094	<ul style="list-style-type: none"> ● VKHB 2066 33214/Q ● VKHB 2067 33209/Q ● VKHB 2066 33214/Q ● VKHB 2068 33210/Q ● VKHB 2051 33213/Q ● VKHB 2065 33208/Q ● VKHB 2071 332330 B/Q ● VKHB 2068 33210/Q ● VKHB 2071 332330 B/Q ● VKHB 2070 32310 J2/Q ● VKHB 2019 32211 J2/Q ● VKHB 2017 32210 J2/Q ● VKHB 2075 33895/33822/Q ● VKHB 2124 33020/Q ● VKHB 2158 33117/Q ● VKHB 2082 33019/Q ● VKHB 2028 33215/Q ● VKHB 2026 32216 J2/Q ● VKHB 2079 330356 A/Q 	VKS 6175	19)
					VKS 6175	20)
					VKS 6157	
					VKS 6158	21)
					VKS 6146	
		VKBA 5038	VKA 4094		VKS 6158	22)
					VKS 6146	
					VKS 6143	9)
		VKBA 5056	VKA 4110		VKS 6176	
		VKBA 5052			VKS 6154	
0 305	<ul style="list-style-type: none"> ● VO 4/11 DL-7 ● VO 4/11 DL-7 ○ HO 7/8 DL-10, NR 7/4 DL-10, NR 7/5 DL-10 	VKBA 5038	VKA 4094	<ul style="list-style-type: none"> ● VKHB 2071 332330 B/Q ● VKHB 2068 33210/Q ● VKHB 2071 332330 B/Q ● VKHB 2070 32310 J2/Q ● VKHB 2162 33021/Q ● VKHB 2161 32019 X/Q 	VKS 6158	21)
					VKS 6146	
					VKS 6158	22)
					VKS 6146	
					VKS 6183	
					VKS 6181	
0 307	<ul style="list-style-type: none"> ● VO 4/11 DL-7 ● VO 4/11 DL-7 ○ HO 7/8 DL-10 	VKBA 5038	VKA 4094	<ul style="list-style-type: none"> ● VKHB 2071 332330 B/Q ● VKHB 2068 33210/Q ● VKHB 2071 332330 B/Q ● VKHB 2070 32310 J2/Q ● VKHB 2162 33021/Q ● VKHB 2161 32019 X/Q 	VKS 6158	21)
					VKS 6146	
					VKS 6158	22)
					VKS 6146	
					VKS 6183	
					VKS 6181	
0 309, 309 D	<ul style="list-style-type: none"> ● VL 1/3-2.1 ● VL 1/3-2.1 ● VL 1/4-1.6 ● VL 1/4-1.6 ● VL 1/4-1.6 	VKBA 5025		<ul style="list-style-type: none"> ● VKHB 2054 2789/2720/QCL7C ● VKHB 2055 1380/1328/Q ● VKHB 2056 33109/Q ● VKHB 2057 33205/QVQ077 ● VKHB 2058 32304 J2/Q ● VKHB 2018 32207 J2/Q ● VKHB 2054 2789/2720/QCL7C ● VKHB 2055 1380/1328/Q ● VKHB 2056 33109/Q ● VKHB 2057 33205/QVQ077 	VKS 6299	4)
					VKS 6299	5)
						6)
						7)
		VKBA 5025			VKS 6299	8)



MAN .../...

	<ul style="list-style-type: none"> VL 1/5-2.3, VL 1/6-2.3, VL 1/7-2.6 VL 2/11 D-3.8 VO 3/9 DL-5 ○ HL 1/2-3.3 ○ HL 1/3-4.5, HL 2/5-4.5, HL 2/9-4.7 	VKBA 5025		<ul style="list-style-type: none"> VKHB 2056 33109/Q VKHB 2057 33205/QVQ077 VKHB 2061 33211/Q VKHB 2064 529656 VKHB 2051 33213/Q VKHB 2065 33208/Q VKHB 2019 32211 J2/Q VKHB 2017 32210 J2/Q VKHB 2075 33895/33822/Q 	VKS 6299	VKS 6148	VKS 6157	VKS 6143 9)
--	--	-----------	--	---	----------	----------	----------	-------------

0 402	<ul style="list-style-type: none"> VL 2/11 D-3.8 VO 4/18 DL-7, VO 4/22 DLE-6.6 	VKBA 5038	VKA 4094	<ul style="list-style-type: none"> VKHB 2061 33211/Q VKHB 2064 529656 VKHB 2071 332330 B/Q VKHB 2070 32310 J2/Q 	VKS 6148	VKS 6158	VKS 6146	
-------	--	-----------	----------	---	----------	----------	----------	--

0 404	<ul style="list-style-type: none"> VL 2/11 D-3.8 VO 4/21 CLE-6.6 VO 4/21 CLE-6.6 VO 4/22 DLE-6.6 VO 4/22 DLE-6.6 VO 4/35 CLE-7.5 VO 4/35 CLE-7.5 ○ HO 4/01 DL-11.5 ○ HO 4/02 CL-11.5, HO 4/04 DCL-11.5 	VKBA 5038	VKA 4094	<ul style="list-style-type: none"> VKHB 2061 33211/Q VKHB 2064 529656 VKHB 2280 BT1-0084/Q VKHB 2068 33210/Q VKHB 2280 BT1-0084/Q VKHB 2070 32310 J2/Q VKHB 2071 332330 B/Q VKHB 2068 33210/Q VKHB 2071 332330 B/Q VKHB 2070 32310 J2/Q VKHB 2280 BT1-0084/Q VKHB 2068 33210/Q VKHB 2280 BT1-0084/Q VKHB 2070 32310 J2/Q VKHB 2124 33020/Q VKHB 2158 33117/Q VKHB 2124 33020/Q VKHB 2158 33117/Q 	VKS 6148	VKS 6150 21)	VKS 6315	VKS 6150 22)	VKS 6315	VKS 6158 21)	VKS 6146	VKS 6158 22)	VKS 6146	VKS 6150 21)	VKS 6315	VKS 6150 22)	VKS 6315	VKS 6176
-------	---	-----------	----------	--	----------	--------------	----------	--------------	----------	--------------	----------	--------------	----------	--------------	----------	--------------	----------	----------

0 405	<ul style="list-style-type: none"> VL 2/11 D-3.8 VO 4/22 DLE-6.6 VO 4/18 DL-7, VO 4/33 DL-6.6, VO 4/34 DL-7 VO 4/18 DL-7, VO 4/33 DL-6.6, VO 4/34 DL-7 	VKBA 5038	VKA 4094	<ul style="list-style-type: none"> VKHB 2061 33211/Q VKHB 2064 529656 VKHB 2071 332330 B/Q VKHB 2070 32310 J2/Q VKHB 2071 332330 B/Q VKHB 2068 33210/Q VKHB 2071 332330 B/Q VKHB 2070 32310 J2/Q 	VKS 6148	VKS 6158	VKS 6146	VKS 6158 21)	VKS 6146	VKS 6158 22)	VKS 6146
-------	--	-----------	----------	--	----------	----------	----------	--------------	----------	--------------	----------



	○	HO 7/02 DLM-10, HO 7/9 DL-10, HO 7/10 DL-11.5, NR 7/4 DL-10, NR 7/5 DL-10			●	VKHB 2162 VKHB 2161	33021/Q 32019 X/Q	VKS 6183 VKS 6181	
O 407	●	VL 2/11 D-3.8			●	VKHB 2061 VKHB 2064	33211/Q 529656	VKS 6148	
	●	VO 4/18 DL-7			●	VKHB 2071 VKHB 2068	332330 B/Q 33210/Q	VKS 6158 VKS 6146	21)
	●	VO 4/18 DL-7	VKBA 5038	VKA 4094	●	VKHB 2071 VKHB 2070	332330 B/Q 32310 J2/Q	VKS 6158 VKS 6146	22)
	●	VO 4/22 DLE-6.6	VKBA 5038	VKA 4094	●	VKHB 2071 VKHB 2070	332330 B/Q 32310 J2/Q	VKS 6158 VKS 6146	
	○	HO 7/02 DLM-10, HO 7/9 DL-10, HO 7/10 DL-11.5			●	VKHB 2162 VKHB 2161	33021/Q 32019 X/Q	VKS 6183 VKS 6181	
O 408	●	VL 2/11 D-3.8			●	VKHB 2061 VKHB 2064	33211/Q 529656	VKS 6148	
	●	VO 4/18 DL-7			●	VKHB 2071 VKHB 2068	332330 B/Q 33210/Q	VKS 6158 VKS 6146	21)
	●	VO 4/18 DL-7	VKBA 5038	VKA 4094	●	VKHB 2071 VKHB 2070	332330 B/Q 32310 J2/Q	VKS 6158 VKS 6146	22)
	●	VO 4/22 DLE-6.6	VKBA 5038	VKA 4094	●	VKHB 2071 VKHB 2070	332330 B/Q 32310 J2/Q	VKS 6158 VKS 6146	
	○	HO 7/02 DLM-10, HO 7/9 DL-10, HO 7/10 DL-11.5			●	VKHB 2162 VKHB 2161	33021/Q 32019 X/Q	VKS 6183 VKS 6181	
O 608 D, 609 D, 611 D, 614 D	●	VL 1/10 C-2.5, VL 1/9 C-2.3	VKBA 5025		●	VKHB 2056 VKHB 2057	33109/Q 33205/QVQ077	VKS 6299	
	○	HL 1/8-4.7			●	VKHB 2154 VKHB 2060	32014 X/Q 32011 X/Q	VKS 6173	
	○	HL 1/9-5.6, HL 2/ 15-5.8	VKBA 5048	VKA 4103	●	VKHB 2155 VKHB 2156	331293/Q 33011/Q	VKS 6172	
	○	HL 2/5-4.5			●	VKHB 2075	33895/33822/Q		
O 814, 817	●	VL 2/10 D-3.5	VKBA 5028		●	VKHB 2061 VKHB 2007	33211/Q 32306 J2/Q	VKS 6148	
	●	VL 2/9 D-3.1	VKBA 5026		●	VKHB 2059 VKHB 2007	33111/Q 32306 J2/Q	VKS 6159	
	○	HL 2/11 D-5.8	VKBA 5048	VKA 4103	●	VKHB 2155 VKHB 2156	331293/Q 33011/Q	VKS 6172	
	○	HL 2/13 D-6.4			●	VKHB 2137 VKHB 2233	JM 714249/ 210/Q 33112/QVB259	VKS 6174	











MERCEDES-BENZ .../...

	○	HL 4/30 DS-6.4, HL 4/30 D-6.4, HL 4/35 D-6.4			●	VKHB 2157 VKHB 2159	32016 X/Q 33113/QVB022	VKS 6175	
0 1114, 1117, 1120	●	VL 2/11 D-3.8			●	VKHB 2061 VKHB 2064	33211/Q 529656	VKS 6148	
	○	HL 4/28 D-7.8			●	VKHB 2041 VKHB 2079	580/572/Q 330356 A/Q	VKS 6178	
	○	HL 4/29 D-9.2			●	VKHB 2158 VKHB 2081	33117/Q 331074/Q	VKS 6178	
0 1317	○	HL 5/1 Z-10			●	VKHB 2083	CK-598 A/ K-592 A		
					●	VKHB 2033	32215 J2/Q		
0 1417	○	HH 4/04 D-12	VKBA 5056	VKA 4110	●	VKHB 2124 VKHB 2158	33020/Q 33117/Q	VKS 6176	
0 1617, 1625, 1628	●	VL 4/2 D-7			●	VKHB 2070	32310 J2/Q		
	●	VO 4/18 DL-7	VKBA 5038	VKA 4094	●	VKHB 2071 VKHB 2070	332330 B/Q 32310 J2/Q	VKS 6158 VKS 6146	
OH 1622, OH 1625, OH 1627, OH 1628, OH 1634	●	VO 4/18 DL-7			●	VKHB 2071 VKHB 2068	332330 B/Q 33210/Q	VKS 6158 VKS 6146	21)
	●	VL 4/10 D-7, VO 4/18 DL-7	VKBA 5038	VKA 4094	●	VKHB 2071 VKHB 2070	332330 B/Q 32310 J2/Q	VKS 6158 VKS 6146	22)
	○	HO 4/01 DL-10	VKBA 5056	VKA 4110	●	VKHB 2124 VKHB 2158	33020/Q 33117/Q	VKS 6176	

MERCEDES-BENZ "Baumuster"











730.013-014					●	VKHB 2051 VKHB 2065	33213/Q 33208/Q	VKS 6157	
730.015					●	VKHB 2066 VKHB 2067	33214/Q 33209/Q	VKS 6175	19)
					●	VKHB 2066 VKHB 2068	33214/Q 33210/Q	VKS 6175	20)
730.035					●	VKHB 2051 VKHB 2065	33213/Q 33208/Q	VKS 6157	
730.042					●	VKHB 2066 VKHB 2067	33214/Q 33209/Q	VKS 6175	19)

									
730.047						<ul style="list-style-type: none"> • VKHB 2051 • VKHB 2065 • VKHB 2066 • VKHB 2068 	33213/Q 33208/Q 33214/Q 33210/Q	VKS 6157 VKS 6175	20)
730.049						<ul style="list-style-type: none"> • VKHB 2066 • VKHB 2067 • VKHB 2066 • VKHB 2068 	33214/Q 33209/Q 33214/Q 33210/Q	VKS 6175 VKS 6175	19) 20)
730.053						<ul style="list-style-type: none"> • VKHB 2051 • VKHB 2065 	33213/Q 33208/Q	VKS 6157	
730.054						<ul style="list-style-type: none"> • VKHB 2066 • VKHB 2067 • VKHB 2066 • VKHB 2068 	33214/Q 33209/Q 33214/Q 33210/Q	VKS 6175 VKS 6175	19) 20)
730.060-062						<ul style="list-style-type: none"> • VKHB 2051 • VKHB 2065 	33213/Q 33208/Q	VKS 6157	
730.502				VKBA 5025		<ul style="list-style-type: none"> • VKHB 2058 • VKHB 2018 • VKHB 2054 • VKHB 2055 • VKHB 2056 • VKHB 2057 	32304 J2/Q 32207 J2/Q 2789/2720/ QCL7C 1380/1328/Q 33109/Q 33205/QVQ077	VKS 6299	6) 7) 8)
730.503-.504				VKBA 5025		<ul style="list-style-type: none"> • VKHB 2054 • VKHB 2055 • VKHB 2056 • VKHB 2057 	2789/2720/ QCL7C 1380/1328/Q 33109/Q 33205/QVQ077	VKS 6299	4) 5)
730.505				VKBA 5025		<ul style="list-style-type: none"> • VKHB 2056 • VKHB 2057 	33109/Q 33205/QVQ077	VKS 6299	
730.506				VKBA 5025		<ul style="list-style-type: none"> • VKHB 2054 • VKHB 2055 • VKHB 2056 • VKHB 2057 	2789/2720/ QCL7C 1380/1328/Q 33109/Q 33205/QVQ077	VKS 6299	4) 5)
730.533				VKBA 5025		<ul style="list-style-type: none"> • VKHB 2056 • VKHB 2057 	33109/Q 33205/QVQ077	VKS 6299	
730.534						<ul style="list-style-type: none"> • VKHB 2054 • VKHB 2055 	2789/2720/ QCL7C 1380/1328/Q		4)



MERCEDES-BENZ "Baumuster" .../...

		VKBA 5025		<ul style="list-style-type: none"> • • 	<ul style="list-style-type: none"> • VKHB 2056 • VKHB 2057 	<ul style="list-style-type: none"> • 33109/Q • 33205/QVQ077 	VKS 6299	5)
730.600, '730.602. -603, 730.630		VKBA 5025		<ul style="list-style-type: none"> • • 	<ul style="list-style-type: none"> • VKHB 2056 • VKHB 2057 	<ul style="list-style-type: none"> • 33109/Q • 33205/QVQ077 	VKS 6299	
730.732		VKBA 5026		<ul style="list-style-type: none"> • • 	<ul style="list-style-type: none"> • VKHB 2059 • VKHB 2007 	<ul style="list-style-type: none"> • 33111/Q • 32306 J2/Q 	VKS 6159	
730.733		VKBA 5028		<ul style="list-style-type: none"> • • 	<ul style="list-style-type: none"> • VKHB 2061 • VKHB 2007 	<ul style="list-style-type: none"> • 33211/Q • 32306 J2/Q 	VKS 6148	
730.830-.832				<ul style="list-style-type: none"> • • 	<ul style="list-style-type: none"> • VKHB 2061 • VKHB 2064 	<ul style="list-style-type: none"> • 33211/Q • 529656 	VKS 6148	
739.003				<ul style="list-style-type: none"> • • 	<ul style="list-style-type: none"> • VKHB 2070 	<ul style="list-style-type: none"> • 32310 J2/Q 		
739.133, 739.176		VKBA 5038	VKA 4094	<ul style="list-style-type: none"> • • 	<ul style="list-style-type: none"> • VKHB 2071 • VKHB 2070 	<ul style="list-style-type: none"> • 332330 B/Q • 32310 J2/Q 	VKS 6158 VKS 6146	22)
739.200-201, 739.203-204, 739.207, 739.209, 211		VKBA 5038	VKA 4094	<ul style="list-style-type: none"> • • • 	<ul style="list-style-type: none"> • VKHB 2071 • VKHB 2068 • VKHB 2071 • VKHB 2070 	<ul style="list-style-type: none"> • 332330 B/Q • 33210/Q • 332330 B/Q • 32310 J2/Q 	VKS 6158 VKS 6146	21) 22)
739.230-233		VKBA 5038	VKA 4094	<ul style="list-style-type: none"> • • • 	<ul style="list-style-type: none"> • VKHB 2071 • VKHB 2068 • VKHB 2071 • VKHB 2070 	<ul style="list-style-type: none"> • 332330 B/Q • 33210/Q • 332330 B/Q • 32310 J2/Q 	VKS 6158 VKS 6146	21) 22)
739.234				<ul style="list-style-type: none"> • • • 	<ul style="list-style-type: none"> • VKHB 2280 • VKHB 2068 • VKHB 2280 • VKHB 2070 	<ul style="list-style-type: none"> • BT1-0084/Q • 33210/Q • BT1-0084/Q • 32310 J2/Q 	VKS 6150 VKS 6315	21) 22)
739.235-.236		VKBA 5038	VKA 4094	<ul style="list-style-type: none"> • • • 	<ul style="list-style-type: none"> • VKHB 2071 • VKHB 2068 • VKHB 2071 • VKHB 2070 	<ul style="list-style-type: none"> • 332330 B/Q • 33210/Q • 332330 B/Q • 32310 J2/Q 	VKS 6158 VKS 6146	21) 22)
739.238				<ul style="list-style-type: none"> • • • 	<ul style="list-style-type: none"> • VKHB 2280 • VKHB 2068 • VKHB 2280 • VKHB 2070 	<ul style="list-style-type: none"> • BT1-0084/Q • 33210/Q • BT1-0084/Q • 32310 J2/Q 	VKS 6150 VKS 6315	21) 22)
739.240				<ul style="list-style-type: none"> • • 	<ul style="list-style-type: none"> • VKHB 2071 • VKHB 2068 	<ul style="list-style-type: none"> • 332330 B/Q • 33210/Q 	VKS 6158 VKS 6146	21)

									
			VKBA 5038	VKA 4094	• •	VKHB 2071 VKHB 2070	332330 B/Q 32310 J2/Q	VKS 6158 VKS 6146	22)
739.241, 739.245					• • •	VKHB 2280 VKHB 2068 VKHB 2280 VKHB 2070	BT1-0084/Q 33210/Q BT1-0084/Q 32310 J2/Q	VKS 6150 VKS 6315 VKS 6150 VKS 6315	21) 22)
739.242			VKBA 5038	VKA 4094	• • •	VKHB 2071 VKHB 2068 VKHB 2071 VKHB 2070	332330 B/Q 33210/Q 332330 B/Q 32310 J2/Q	VKS 6158 VKS 6146 VKS 6158 VKS 6146	21) 22)
739.245					• • •	VKHB 2280 VKHB 2068 VKHB 2280 VKHB 2070	BT1-0084/Q 33210/Q BT1-0084/Q 32310 J2/Q	VKS 6150 VKS 6315 VKS 6150 VKS 6315	21) 22)
740.200, 740.230-233					• •	VKHB 2162 VKHB 2161	33021/Q 32019 X/Q	VKS 6183 VKS 6181	
741.001, 741.030-.031					• •	VKHB 2019 VKHB 2017	32211 J2/Q 32210 J2/Q	VKS 6143	9)
741.200, 741.202-.203, 741.301-.304, 741.330-.337					• •	VKHB 2075	33895/33822/Q		
741.560, 741.580					• •	VKHB 2154 VKHB 2060	32014 X/Q 32011 X/Q	VKS 6173	
741.580, 742.420-.421, 742.436, 742.440			VKBA 5048	VKA 4103	• •	VKHB 2155 VKHB 2156	331293/Q 33011/Q	VKS 6172	
742.450					• •	VKHB 2137 VKHB 2233	JM 714249/ 210/Q 33112/QVB259	VKS 6174	
742.471, 742.481			VKBA 5048	VKA 4103	• •	VKHB 2155 VKHB 2156	331293/Q 33011/Q	VKS 6172	
744.601-602, 744.604, 744.630-632					• •	VKHB 2026 VKHB 2079	32216 J2/Q 330356 A/Q		
744.701-702, 744.704. 744.706-707			VKBA 5052		• •	VKHB 2082 VKHB 2028	33019/Q 33215/Q	VKS 6154	
744.731, 744.733-735			VKBA 5052		• •	VKHB 2082 VKHB 2028	33019/Q 33215/Q	VKS 6154	



MERCEDES-BENZ "Baumuster" .../...

744.900, 744.904,
744.917-.918

- ● VKHB 2041 580/572/Q VKS 6178
- VKHB 2079 330356 A/Q

744.920

- ● VKHB 2158 33117/Q VKS 6178
- VKHB 2081 331074/Q

744.950, 744.958,
744.960

- ● VKHB 2157 32016 X/Q VKS 6175
- VKHB 2159 33113/QVB022

745.139

- ● VKHB 2083 CK-598 A/ K-592 A
- VKHB 2033 32215 J2/Q

745.200, 745.202,
745.207, 745.230

VKBA 5052 ● ● VKHB 2082 33019/Q VKS 6154

● VKHB 2028 33215/Q

745.616

VKBA 5056 VKA 4110 ● ● VKHB 2124 33020/Q VKS 6176

● VKHB 2158 33117/Q

745.800-801,
745.807-809,
745.840-849

VKBA 5056 VKA 4110 ● ● VKHB 2124 33020/Q VKS 6176

● VKHB 2158 33117/Q

745.860-864

- ● VKHB 2124 33020/Q
- VKHB 2158 33117/Q

745.871-872,
745.874-877

VKBA 5056 VKA 4110 ● ● VKHB 2124 33020/Q VKS 6176

● VKHB 2158 33117/Q

745.990, 745.996-997

- ● VKHB 2124 33020/Q
- VKHB 2158 33117/Q

748.501

- ● VKHB 2162 33021/Q VKS 6183
- VKHB 2161 32019 X/Q VKS 6181

748.512-515,
748.517-524, 748.526

- ● VKHB 2162 33021/Q VKS 6183
- VKHB 2161 32019 X/Q VKS 6181

749.210-212











- ● VKHB 2162 33021/Q VKS 6183
- VKHB 2161 32019 X/Q VKS 6181

RENAULT (RVI)

AGORA citybus ●

VKBA 5308

- ●
- ●
- ● VKHB 2192 JF 9549/9510 VKS 6140
- VKHB 2194 33216/Q

										
ER 100-2	●	RI 6A				●	VKHB 2051 VKHB 2067	33213/Q 33209/Q	VKS 6202	
	○					●	VKHB 2185 VKHB 2042	52375/52618 683/372	VKS 6201	
FRH	●	RI 65 R				●	VKHB 2066 VKHB 2236	33214/Q 32309 BJ2/ QCL7C	VKS 6303	40)
	○	PX 1141				●	VKHB 2192 VKHB 2194	JF 9549/9510 33216/Q	VKS 6140	40)
FRI	●	RI 65 R				●	VKHB 2066 VKHB 2004	33214/Q 32309 J2/Q	VKS 6303	38)
	●	RI 65 R				●	VKHB 2066 VKHB 2236	33214/Q 32309 BJ2/ QCL7C	VKS 6303	39)
	○	PX 1141				●	VKHB 2192 VKHB 2194	JF 9549/9510 33216/Q	VKS 6201	36)
	○	PX 1141				●	VKHB 2192 VKHB 2194	JF 9549/9510 33216/Q	VKS 6140	37)
G 105, G 105 S, G 45, G 45 S	●	E 6A				●	VKHB 2066 VKHB 2067	33214/Q 33209/Q	VKS 6175	23)
	●	E 6A				●	VKHB 2066 VKHB 2184	33214/Q T2ED 045	VKS 6175	24)
	○	P 1321 B				●	VKHB 2185 VKHB 2042	52375/52618 683/372	VKS 6201	
GX 187	●	RI 6A				●	VKHB 2051 VKHB 2067	33213/Q 33209/Q	VKS 6202	
	○	PX 1021, PX SAR 1021				●	VKHB 2185 VKHB 2042	52375/52618 683/372	VKS 6201	
GX 317	●		VKBA 5308			●				
	○					●	VKHB 2192 VKHB 2194	JF 9549/9510 33216/Q	VKS 6140	
MEGABUS	●	RI 6A				●	VKHB 2051 VKHB 2067	33213/Q 33209/Q	VKS 6202	
	○	PX 1021, PX SAR 1021				●	VKHB 2185 VKHB 2042	52375/52618 683/372	VKS 6201	
PER 180		○	PX 1021 G, PX SAR 1021 A			●	VKHB 2185 VKHB 2042	52375/52618 683/372	VKS 6201	
PG 60, PG 60 S	●	E 6A				●	VKHB 2066 VKHB 2067	33214/Q 33209/Q	VKS 6175	23)
	●	E 6A				●	VKHB 2066 VKHB 2184	33214/Q T2ED 045	VKS 6175	24)



RENAULT (RVI) .../...

	○ P 1321			● ●	VKHB 2185 VKHB 2042	52375/52618 683/372	VKS 6201	
PGC 191, PGC 231	● E 5A ○ P 1021 J			● ● ●	VKHB 2051 VKHB 2067 VKHB 2185 VKHB 2042	33213/Q 33209/Q 52375/52618 683/372	VKS 6202 VKS 6201	
PR 10	● E 5A ○ PX 821 G			● ● ●	VKHB 2051 VKHB 2067	33213/Q 33209/Q	VKS 6202 VKS 6234	
PR 100	● RI 6A ● RI 6A ○ P 1021 X, PX 1021 E, G			● ● ● ●	VKHB 2287 VKHB 2056 VKHB 2287 VKHB 2067 VKHB 2185 VKHB 2042	JH211749/ JH211710 33109/Q JH211749/ JH211710 33209/Q 52375/52618 683/372	VKS 6202 44) VKS 6202 45) VKS 6201 35)	
PR 100-2	● RI 6A ○			● ● ●	VKHB 2051 VKHB 2067 VKHB 2185 VKHB 2042	33213/Q 33209/Q 52375/52618 683/372	VKS 6202 VKS 6201	
PR 100-3, PR 112, PR 118	● ○ PU 04 PS 08	VKBA 5308		● ● ●	VKHB 2192 VKHB 2194	JF 9549/9510 33216/Q	VKS 6140	
PR 12	● E 5A ○ PX 821 G			● ● ●	VKHB 2051 VKHB 2067	33213/Q 33209/Q	VKS 6202 VKS 6234	
PR 14	● E 5A ○ P 1021, PX 1021			● ● ●	VKHB 2051 VKHB 2067 VKHB 2185 VKHB 2042	33213/Q 33209/Q 52375/52618 683/372	VKS 6202 VKS 6201	
PR 180	● RI 6A ● RI 6A			● ● ●	VKHB 2051 VKHB 2067 VKHB 2287 VKHB 2067	33213/Q 33209/Q JH211749/ JH211710 33209/Q	VKS 6202 VKS 6202 35)	



		○ PX 1021, PX SAR 1021			● ●	VKHB 2185 VKHB 2042	52375/52618 683/372	VKS 6201	
PR 8C	●	E 5A			● ●	VKHB 2051 VKHB 2067	33213/Q 33209/Q	VKS 6202	41)
	●	E 5A			● ●	VKHB 2051 VKHB 2067	33213/Q 33209/Q	VKS 6175	42)
	●	E 5A			● ●	VKHB 2051 VKHB 2068	33213/Q 33210/Q	VKS 6175	43)
	○	P 1140			● ●	VKHB 2161 VKHB 2158	32019 X/Q 33117/Q	VKS 6201	
TRACER	●	E 70 XD	VKBA 5308		● ●				47)
	○	P 1140 E			● ●	VKHB 2192 VKHB 2158	JF 9549/9510 33117/Q	VKS 6201	
	○	P 1141 E			● ●	VKHB 2192 VKHB 2194	JF 9549/9510 33216/Q	VKS 6201	
SCANIA									
F 82 CL, S 82 CL	●	AM60	VKBA 5064		● ●	VKHB 2003 VKHB 2004	32312 J2/Q 32309 J2/Q	VKS 6108	10)
	○	R642, R 653	VKBA 5067	VKA 4036	● ●	VKHB 2029 VKHB 2029	HM 218248/W/ 2A/210/2A/Q HM 218248/W/ 2A/210/2A/Q	VKS 6111 VKS 6105	10)
K 82	●		VKBA 5064		● ●	VKHB 2003 VKHB 2004	32312 J2/Q 32309 J2/Q	VKS 6108	
	○	R642, R 653, R 750	VKBA 5067	VKA 4036	● ●	VKHB 2029 VKHB 2029	HM 218248/W/ 2A/210/2A/Q HM 218248/W/ 2A/210/2A/Q	VKS 6111 VKS 6105	
	○	R642, R 653	VKBA 5067	VKA 4036	● ●	VKHB 2029 VKHB 2029	HM 218248/W/ 2A/210/2A/Q HM 218248/W/ 2A/210/2A/Q	VKS 6111 VKS 6105	10)
S 82 HR	●	AM55			● ●	VKHB 2002 VKHB 2001	32311 J2 32308 J2/Q		10)
	○	R 653	VKBA 5067	VKA 4036	● ●	VKHB 2029 VKHB 2029	HM 218248/W/ 2A/210/2A/Q HM 218248/W/ 2A/210/2A/Q	VKS 6111 VKS 6105	10)
B 86, BF 86	●	AM55			● ●	VKHB 2001 VKHB 2002 VKHB 2001	32308 J2/Q 32311 J2 32308 J2/Q		39) 40)
	●	AM55			● ●	VKHB 2003 VKHB 2004	32312 J2/Q 32309 J2/Q	VKS 6108	10)
	●	AM60	VKBA 5064		● ●	VKHB 2003 VKHB 2004	32312 J2/Q 32309 J2/Q	VKS 6108	10)



SCANIA .../...

	○ R653			●	VKHB 2030	32218 J2/Q		39)
				●	VKHB 2030	32218 J2/Q	VKS 6105	
	○ R640			●	VKHB 2026	32216 J2/Q		39)
				●	VKHB 2033	32215 J2/Q		
	○ R640			●	VKHB 2026	32216 J2/Q	VKS 6109	40)
				●	VKHB 2028	33215/Q		

BR 86	●			●	VKHB 2001	32308 J2/Q		41)
	●			●	VKHB 2002	32311 J2		42)
	●		VKBA 5064	●	VKHB 2001	32308 J2/Q		
	●		VKBA 5064	●	VKHB 2003	32312 J2/Q	VKS 6108	43)
				●	VKHB 2004	32309 J2/Q		
		○ R640		●	VKHB 2003	32312 J2/Q	VKS 6108	44)
				●	VKHB 2004	32309 J2/Q		
		○ R640		●	VKHB 2026	32216 J2/Q		45)
				●	VKHB 2033	32215 J2/Q		
		○ R651		●	VKHB 2026	32216 J2/Q	VKS 6109	46)
			●	VKHB 2028	33215/Q			
	○ R653			●	VKHB 2030	32218 J2/Q		
				●	VKHB 2030	32218 J2/Q	VKS 6105	
	○ R653	VKBA 5067	VKA 4036	●	VKHB 2030	32218 J2/Q		45)
				●	VKHB 2030	32218 J2/Q	VKS 6105	
	○ R653	VKBA 5067	VKA 4036	●	VKHB 2029	HM 218248/W/ 2A/210/2A/Q	VKS 6111	46)
				●	VKHB 2029	HM 218248/W/ 2A/210/2A/Q	VKS 6105	

K92CL, K92 CR	●		VKBA 5064		●	VKHB 2003	32312 J2/Q	VKS 6108	47)
					●	VKHB 2004	32309 J2/Q		
	○ AD90, ADA90	VKBA 5067	VKA 4036	●	VKHB 2029	HM 218248/W/ 2A/210/2A/Q	VKS 6111	48)	
				●	VKHB 2029	HM 218248/W/ 2A/210/2A/Q	VKS 6105		

K 93 CRB	●	AM56			●	VKHB 2228	T2EE 060/Q	VKS 6284	49)
					●	VKHB 2004	32309 J2/Q		
	●	AM61, AMA61			●	VKHB 2003	32312 J2/Q		52)
					●	VKHB 2004	32309 J2/Q		
	●	AM61, AMA61		VKA 4207	●	VKHB 2003	32312 J2/Q	VKS 6261	51)
					●	VKHB 2004	32309 J2/Q		
	●	AMA56			●	VKHB 2228	T2EE 060/Q		50)
					●	VKHB 2004	32309 J2/Q		
	○ AD90, ADA90	VKBA 5067	VKA 4036	●	VKHB 2029	HM 218248/W/ 2A/210/2A/Q	VKS 6111	48)	
				●	VKHB 2029	HM 218248/W/ 2A/210/2A/Q	VKS 6105		

B 111	●				●	VKHB 2001	32308 J2/Q		53)
	●				●	VKHB 2002	32311 J2		56)
				●	VKHB 2001	32308 J2/Q			













	○ R640				● VKHB 2026 ● VKHB 2033	32216 J2/Q 32215 J2/Q		53)
	○ R640				● VKHB 2026 ● VKHB 2028	32216 J2/Q 33215/Q	VKS 6109	54)
	○ R640				● VKHB 2026 ● VKHB 2028	32216 J2/Q 33215/Q	VKS 6109	55)
	○ R653	VKBA 5067	VKA 4036		● VKHB 2029 ● VKHB 2029	HM 218248/W/ 2A/210/2A/Q HM 218248/W/ 2A/210/2A/Q	VKS 6111 VKS 6105	56)
	○ R653				● VKHB 2030 ● VKHB 2030	32218 J2/Q 32218 J2/Q	VKS 6105	5)
	○ R653				● VKHB 2030 ● VKHB 2030	32218 J2/Q 32218 J2/Q	VKS 6105	53)
BF 111, BF 111-CKD	●		VKBA 5064		● VKHB 2003 ● VKHB 2004	32312 J2/Q 32309 J2/Q	VKS 6108	10)
	○ R640				● VKHB 2026 ● VKHB 2033	32216 J2/Q 32215 J2/Q		53)
	○ R640				● VKHB 2026 ● VKHB 2028	32216 J2/Q 33215/Q	VKS 6109	54)
	○ R640				● VKHB 2026 ● VKHB 2028	32216 J2/Q 33215/Q	VKS 6109	55)
	○ R653				● VKHB 2030 ● VKHB 2030	32218 J2/Q 32218 J2/Q	VKS 6105	53)
	○ R653	VKBA 5067	VKA 4036		● VKHB 2029 ● VKHB 2029	HM 218248/W/ 2A/210/2A/Q HM 218248/W/ 2A/210/2A/Q	VKS 6111 VKS 6105	56)
	○ R653				● VKHB 2030 ● VKHB 2030	32218 J2/Q 32218 J2/Q	VKS 6105	5)
BR 112, N 112	●		VKBA 5064		● VKHB 2003 ● VKHB 2004	32312 J2/Q 32309 J2/Q	VKS 6108	57)
	●		VKBA 5064		● VKHB 2003 ● VKHB 2004	32312 J2/Q 32309 J2/Q	VKS 6108	58)
	○ R653				● VKHB 2030 ● VKHB 2030	32218 J2/Q 32218 J2/Q	VKS 6105	59)
	○ R653	VKBA 5067	VKA 4036		● VKHB 2029 ● VKHB 2029	HM 218248/W/ 2A/210/2A/Q HM 218248/W/ 2A/210/2A/Q	VKS 6111 VKS 6105	60)
	○ Trailing axle		VKA 4038		● VKHB 2029 ● VKHB 2029	HM 218248/W/ 2A/210/2A/Q HM 218248/W/ 2A/210/2A/Q	VKS 6111	
F 112 CL, S 112 CL	●	AM55			● VKHB 2002 ● VKHB 2001	32311 J2 32308 J2/Q		61)
	●	AM55			● VKHB 2002 ● VKHB 2001	32311 J2 32308 J2/Q	VKS 6108	62)
	●	AM60	VKBA 5064		● VKHB 2003 ● VKHB 2004	32312 J2/Q 32309 J2/Q	VKS 6108	10)
	○ R642, R 653, R 750	VKBA 5067	VKA 4036		● VKHB 2029	HM 218248/W/ 2A/210/2A/Q	VKS 6111	



SCANIA .../...

	●		VKBA 5064		●	VKHB 2029	HM 218248/W/ 2A/210/2A/Q	VKS 6105	
K 112 CLB	●	○ R653, R750	VKBA 5064 VKBA 5067	VKA 4036	● ● ● ●	VKHB 2003 VKHB 2004 VKHB 2029 VKHB 2029	32312 J2/Q 32309 J2/Q HM 218248/W/ 2A/210/2A/Q HM 218248/W/ 2A/210/2A/Q	VKS 6108 VKS 6111 VKS 6105	48) 48)
N 111 AL	●	○ ○ R653	VKBA 5064 VKBA 5067 VKBA 5067	VKA 4036 VKA 4036	● ● ● ● ●	VKHB 2003 VKHB 2004 VKHB 2029 VKHB 2029 VKHB 2029 VKHB 2029	32312 J2/Q 32309 J2/Q HM 218248/W/ 2A/210/2A/Q HM 218248/W/ 2A/210/2A/Q HM 218248/W/ 2A/210/2A/Q HM 218248/W/ 2A/210/2A/Q	VKS 6108 VKS 6111 VKS 6105 VKS 6111 VKS 6105	63) 65) 64)
N 112 CLB	●	○ R653, R760	VKBA 5064 VKBA 5067	VKA 4036	● ● ●	VKHB 2003 VKHB 2004 VKHB 2029 VKHB 2029	32312 J2/Q 32309 J2/Q HM 218248/W/ 2A/210/2A/Q HM 218248/W/ 2A/210/2A/Q	VKS 6108 VKS 6111 VKS 6105	66) 64)
K 113 CLB	● ● ● ● ● ○ AD90, ADA90	AM56 AM61, AMA61 AM61, AMA61 AMA56 AMA56	VKBA 5067	VKA 4207 VKA 4036	● ● ● ● ● ● ● ●	VKHB 2228 VKHB 2004 VKHB 2003 VKHB 2004 VKHB 2003 VKHB 2004 VKHB 2228 VKHB 2004 VKHB 2228 VKHB 2004 VKHB 2029 VKHB 2029	T2EE 060/Q 32309 J2/Q 32312 J2/Q 32309 J2/Q 32312 J2/Q 32309 J2/Q T2EE 060/Q 32309 J2/Q T2EE 060/Q 32309 J2/Q HM 218248/W/ 2A/210/2A/Q HM 218248/W/ 2A/210/2A/Q	VKS 6261 VKS 6284 VKS 6111 VKS 6105	68) 69) 68) 67) 48)
K 113 TLA, K 113 TLB	● ● ● ●	AMA56 AMA56		VKA 4207	● ● ● ● ●	VKHB 2228 VKHB 2004 VKHB 2228 VKHB 2004 VKHB 2003 VKHB 2004 VKHB 2003 VKHB 2004	T2EE 060/Q 32309 J2/Q T2EE 060/Q 32309 J2/Q 32312 J2/Q 32309 J2/Q 32312 J2/Q 32309 J2/Q	VKS 6284 VKS 6261	70) 71) 72) 73)

										
	•	AMA61		VKA 4207	•	VKHB 2003 VKHB 2004	32312 J2/Q 32309 J2/Q	VKS 6261	70)	
	•	AMA61			•	VKHB 2003 VKHB 2004	32312 J2/Q 32309 J2/Q		71)	
	○	ADA90	VKBA 5067	VKA 4036	•	VKHB 2029	HM 218248/W/ 2A/210/2A/Q	VKS 6111	48)	
	•				•	VKHB 2029	HM 218248/W/ 2A/210/2A/Q	VKS 6105		
	○	Trailing axle	VKBA 5064		•	VKHB 2003 VKHB 2004	32312 J2/Q 32309 J2/Q	VKS 6108	48)	
L 113 CLB	•	AM56			•	VKHB 2228 VKHB 2004	T2EE 060/Q 32309 J2/Q	VKS 6284	67)	
	•	AMA56			•	VKHB 2228 VKHB 2004	T2EE 060/Q 32309 J2/Q		68)	
	•	AM61, AMA61		VKA 4207	•	VKHB 2003 VKHB 2004	32312 J2/Q 32309 J2/Q	VKS 6261	49)	
	•	AM61, AMA61			•	VKHB 2003 VKHB 2004	32312 J2/Q 32309 J2/Q		50)	
	○	AD90, ADA90	VKBA 5067	VKA 4036	•	VKHB 2029	HM 218248/W/ 2A/210/2A/Q	VKS 6111	48)	
	•				•	VKHB 2029	HM 218248/W/ 2A/210/2A/Q	VKS 6105		
N 113 ALB	•	AMA56			•	VKHB 2228 VKHB 2004	T2EE 060/Q 32309 J2/Q	VKS 6284	74)	
	•	AMA56			•	VKHB 2228 VKHB 2004	T2EE 060/Q 32309 J2/Q		75)	
	•	AMA56		VKA 4207	•	VKHB 2003 VKHB 2004	32312 J2/Q 32309 J2/Q	VKS 6261	76)	
	•	AMA56			•	VKHB 2003 VKHB 2004	32312 J2/Q 32309 J2/Q		77)	
	○	ADA90	VKBA 5067	VKA 4036	•	VKHB 2029	HM 218248/W/ 2A/210/2A/Q	VKS 6111	48)	
	•				•	VKHB 2029	HM 218248/W/ 2A/210/2A/Q	VKS 6105		
	○	ASA90		VKA 4038	•	VKHB 2029	HM 218248/W/ 2A/210/2A/Q	VKS 6111	48)	
	•				•	VKHB 2029	HM 218248/W/ 2A/210/2A/Q			
N 113 CLB, N 113 CRB	•	AMA56			•	VKHB 2228 VKHB 2004	T2EE 060/Q 32309 J2/Q	VKS 6284	78)	
	•	AMA56			•	VKHB 2228 VKHB 2004	T2EE 060/Q 32309 J2/Q		79)	
	•	AMA56		VKA 4207	•	VKHB 2003 VKHB 2004	32312 J2/Q 32309 J2/Q	VKS 6261	80)	
	•	AMA56			•	VKHB 2003 VKHB 2004	32312 J2/Q 32309 J2/Q		81)	
	•	AMA56			•	VKHB 2228 VKHB 2004	T2EE 060/Q 32309 J2/Q			
	•	AMA61			•	VKHB 2003 VKHB 2004	32312 J2/Q 32309 J2/Q		96)	
	•	AMA61		VKA 4207	•	VKHB 2003 VKHB 2004	32312 J2/Q 32309 J2/Q	VKS 6261	97)	



SCANIA .../...

	○ ADA90	VKBA 5067	VKA 4036	●	VKHB 2029	HM 218248/W/ 2A/210/2A/Q	VKS 6111	82)
				●	VKHB 2029	HM 218248/W/ 2A/210/2A/Q	VKS 6105	











BR 116	●			●	VKHB 2001	32308 J2/Q		41)
	●		VKBA 5064	●	VKHB 2003	32312 J2/Q	VKS 6108	83)
	●			●	VKHB 2004	32309 J2/Q		
	●			●	VKHB 2002	32311 J2		42)
	●		VKBA 5064	●	VKHB 2001	32308 J2/Q		
	●		VKBA 5064	●	VKHB 2003	32312 J2/Q	VKS 6108	84)
	●			●	VKHB 2004	32309 J2/Q		
	●		VKBA 5064	●	VKHB 2003	32312 J2/Q	VKS 6108	44)
	●			●	VKHB 2004	32309 J2/Q		
	○ R653, R750			●	VKHB 2030	32218 J2/Q		45)

VOLVO

B 10M, B 9M, B 10B, BLE, B 10L	●		VKBA 5099	●	VKHB 2013	6386/K-6320/Q	VKS 6114	134)	
	●		VKBA 5124	VKA 4004	●	VKHB 2014	537/532 X/Q		
	○ Trailing axle		VKBA 5124	VKA 4004	●	VKHB 2024	T2ED 070/ QCLNVB061	VKS 6134	135)
	○ Trailing axle				●	VKHB 2036	39580/W/2/ 39520/2/Q		
	○ Trailing axle		VKBA 5124	VKA 4004	●	VKHB 2024	T2ED 070/ QCLNVB061	VKS 6134	135)
	○ Trailing axle				●	VKHB 2036	39580/W/2/ 39520/2/Q		
	○ Trailing axle		VKBA 5099		●	VKHB 2013	6386/K-6320/Q	VKS 6114	134)
	○ Trailing axle		VKBA 5262	VKA 4246	●	VKHB 2014	537/532 X/Q		

B 10R	●		VKBA 5124	VKA 4004	●	VKHB 2024	T2ED 070/ QCLNVB061	VKS 6134	139)
	●				●	VKHB 2036	39580/W/2/ 39520/2/Q		

	●		VKBA 5124	VKA 4004	●	VKHB 2024	T2ED 070/ QCLNVB061	VKS 6134	138)
					●	VKHB 2036	39580/W/2/ 39520/2/Q		

											
		●		VKBA 5099			●	VKHB 2013 VKHB 2014	6386/K-6320/Q 537/532 X/Q	VKS 6114	137)
		○		VKBA 5262	VKA 4246		●	VKHB 2042 VKHB 2043	683/372 663/653/Q	VKS 6135 VKS 6298	35)
B 12		●		VKBA 5124	VKA 4004		●	VKHB 2024	T2ED 070/ QCLNVB061 39580/W/2/ 39520/2/Q	VKS 6134	
		○	Trailing axle	VKBA 5124	VKA 4004		●	VKHB 2024	T2ED 070/ QCLNVB061 39580/W/2/ 39520/2/Q	VKS 6134	
		○		VKBA 5262	VKA 4246		●	VKHB 2042 VKHB 2043	683/372 663/653/Q	VKS 6135 VKS 6298	
B 57, BB57		●		VKBA 5099			●	VKHB 2013 VKHB 2014	6386/K-6320/Q 537/532 X/Q	VKS 6114	119)
		●		VKBA 5099			●	VKHB 2013 VKHB 2014	6386/K-6320/Q 537/532 X/Q	VKS 6114	120)
		○					●	VKHB 2040 VKHB 2041	594/592 A/Q 580/572/Q	VKS 6298	120)
		○					●	VKHB 2040 VKHB 2041	594/592 A/Q 580/572/Q	VKS 6135 VKS 6298	122)
		○					●	VKHB 2040 VKHB 2041	594/592 A/Q 580/572/Q	VKS 6298	121)
B 58		●		VKBA 5099			●	VKHB 2013 VKHB 2014	6386/K-6320/Q 537/532 X/Q	VKS 6114	
		○					●	VKHB 2040 VKHB 2041	594/592 A/Q 580/572/Q	VKS 6298	12)
		○					●	VKHB 2040 VKHB 2041	594/592 A/Q 580/572/Q	VKS 6298	124)
		○					●	VKHB 2040 VKHB 2041	594/592 A/Q 580/572/Q	VKS 6298	123)
B 59		●		VKBA 5099			●	VKHB 2013 VKHB 2014	6386/K-6320/Q 537/532 X/Q	VKS 6114	
		○		VKBA 5262	VKA 4246		●	VKHB 2042 VKHB 2043	683/372 663/653/Q	VKS 6135 VKS 6298	
B 6		●					●	VKHB 2017 VKHB 2018	32210 J2/Q 32207 J2/Q		125)
		●		VKBA 5124	VKA 4004		●	VKHB 2024	T2ED 070/ QCLNVB061 39580/W/2/ 39520/2/Q	VKS 6134	127)
		●					●	VKHB 2021	JM207049- 90N90	VKS 6239	126)
		●					●	VKHB 2020	32208 J2/Q		
		○					●	VKHB 2065	33208/Q		153)
		○					●	VKHB 2046 VKHB 2047	33015/Q 33013/Q		128)



VOLVO .../...

	○				●	VKHB 2048	33018/Q	VKS 6139	129)
					●	VKHB 2046	33015/Q		
	○				●	VKHB 2048	33018/Q	VKS 6140	152)
					●	VKHB 2046	33015/Q		
	○				●	VKHB 2163	33022	VKS 6139	130)
					●	VKHB 2165	33220		
	○				●	VKHB 2221	47678/47620/Q	VKS 6207	154)
					●	VKHB 2175	39590/39520/Q		

B 7	●		VKBA 5124	VKA 4004	●	VKHB 2024	T2ED 070/ QCLNVB061	VKS 6134	131)
					●	VKHB 2036	39580/W/2/ 39520/2/Q		
	○				●	VKHB 2040	594/592 A/Q	VKS 6136	131)
					●	VKHB 2041	580/572/Q		

B 7R	●		VKBA 5285	VKA 4265	●	VKHB 2024	T2ED 070/ QCLNVB061	VKS 6134	11)
					●	VKHB 2036	39580/W/2/ 39520/2/Q		
	○		VKBA 5101	VKA 4266	●	VKHB 2042	683/372	VKS 6135	
					●	VKHB 2043	663/653/Q	VKS 6298	

B 7F, B 7FA	●		VKBA 5099		●	VKHB 2013	6386/K-6320/Q	VKS 6114	132)
					●	VKHB 2014	537/532 X/Q		
	●		VKBA 5124	VKA 4004	●	VKHB 2024	T2ED 070/ QCLNVB061	VKS 6134	133)
					●	VKHB 2036	39580/W/2/ 39520/2/Q		
	○		VKBA 5262	VKA 4246	●	VKHB 2042	683/372	VKS 6135	
					●	VKHB 2043	663/653/Q	VKS 6298	



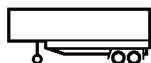

BPW

ZRZ-8010, EHZ-9010	282
ZRZ-10010	282
ERZ-10010, EHZ-11010	282
H/R 6,5 - 9 tons, KH/KR 6,5 - 9 tons	282
NH/NR 6 - 9 tons	282
HL/HLS 6,5 - 9 tons	282
ECO: H/R 6,5 - 9 tons, KH/KR 6,5 - 9 tons, NH/NR 6,5 - 9 tons	282
ECO/ECO-MAXX, SH/SKH 8-9 tons	282
ECO-Plus, 8-9 t	282
HL/HLS 10 - 12 tons	282
HL/HLS 10 - 12 ton	282
ECO: H/R 10-12 tons, KH/KR 10-12 tons, NH/NR 10-12 tons	282
ECO/ECO-MAXX, SH/SKH 10-12 tons	282
ECO-Plus, 10-12 t	282
H/R 10-12 tons, KH/HR 10-12 tons	283
NH/NR 10-12 tons	283
NR 13 - 14 tons	283

FRUEHAUF

Propar axle (P-series)	283
SMB OA/VA	283

GIGANT (SAE)

DH4 05506 3334	283
DH5/6 09010 3745, DH5/6 09010 4345	283
DH6 10010 4345, DH6 10008 3745	283
GH4 05506 3010	283
GHK1 12010	283
GNV5 10010 3020	283
GNV5 12010 3620	283
GNVH5 10010 3020, GNVH5 10010 3620, GNVH5 12010 3020, GNVH5 12010 3620	284
GNVH5 12010 4220	284
GNVH5/6 09010 4218	284
GV 2001 10510 3020	284
GV 2001 12010 3020	284
GVH5 10008 3620, GVH5 10010 3020, GVH5 10010 3620, GVH5 10010 4220, GVH5 12008 3620, GVH5 12010 3020, GVH5 12010 3620	284
GVH5 12010 4220	284
GVH5/6 09010 4218	284
GZV5 12010 4220	284
SH3 10510 3020, SNH3 10510 3020	284
SV2 05506 3012	284
SV2 06706 3015	284
SV2 14010 4220 (340120)	284
SV2 20010 4220	284
SV3 10508 3520 (340022)	285
SV3 10510 3020 (340049, 340109, 340253)	285
SV3 12010 3020, SV3 13010 3520 (340250)	285
5120/S32	285
5122/S33	285
5203/S44	285
5204/S44	285
5205/S44	285
5206/S44, 5207R/S44	285
7103/S33	285
7104/S35	285

7121/S33	285
7404/S33	285
9164/S35	285
9303/S4420	285
9304/S4420	286
9404/S35	286

KÄSSBOHRER

10 tons, 09-01.030, 09-01.062, 09-01.075, 09-01.077, 09-01.089, 09-01.093, 09-01.100	286
6,5 tons, 09-01.087, 09-01.088	286
9 tons, 09-01.111, 09-01.112, 09-01.113, 09-01.114, 09-01.119, 09-01.121, 09-01.122	286

MERCEDES-BENZ DISCOS

NR 5/10 DCL-9	286
---------------------	-----

MERITOR (ROR)

TE 9000, TE 9300	286
TM 22000, TM 22500, TM 25000	286
TM 33000	286
LM 9000	286

MONTENEGRO

7,5 T	286
8 T	286
8,5 T	287
9,5 T	287
10,5 T	287
11 T	287
11,5 T	287
13 T	287

SAF

EBN 3140-6, EBN 3130/12"	287
EBN 4040, ESN 4040	287
EBN 4530, EBN 4535, EBN 4540, EBN 4540-6	287
ESN 4540, ESN 5030, EZN 5030, RS 5030, WESN 5030, WEZN 5030	287
ESN 5542	288
ESN 6030, EZN 6030, WESN 6030, WEZN 6030, WEZN 6030/12"	288
RZM 13130	288
RBM 8442, RSM 8442, RSM 8442-8, RSM 11242, RZM 8442, RZM 8442-8, RZM 11242, WRZM 8442, WRZM 8442-8, WRZM 11242, RLBM 8442, RLSM 8442, RLSM 11242, WRLZM 8130, WRLZM 8435-8, WRLZM 8435-10, WRLZM 11030, WRLZM 11035-8, WRLZM 11035-10, WZRLZM 8130, WZRLZM 1103	288
WRZM 8435-8, WRZM 8435-10, WRZM 11035-8, WRZM 11035-10	288
RBM 8442/12	288
RSM 6242/12-8, RSM 6242/12-10, WRZM 6242, WRZM 6242-8	288
EBN 5535	288
RLSM 9042, RLSM 9042/20, RSM 6542, RSM 9042, RSM 9042/20	288
RZM 16242, RZT 16242	288



SMB

SMB OAVA289

TRAILOR

L 200; L 300 TM; L400 TEM289

SMB OAVA289

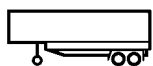

BPW

ZRZ-8010, EHZ-9010	1973-82	VKBA 5502		<ul style="list-style-type: none"> ● VKHB 2028 ● VKHB 2303 	33215/Q 32310 TN9		VKN 507 VKN 502
ZRZ-10010	1973-77			<ul style="list-style-type: none"> ● VKHB 2225 ● VKHB 2217 	33217/Q 33213 TN9/QVT621		
ERZ-10010, EHZ-11010	1977-82			<ul style="list-style-type: none"> ● VKHB 2225 ● VKHB 2217 	33217/Q 33213 TN9/QVT621		
H/R 6,5 - 9 tons, KH/KR 6,5 - 9 tons	1982-	VKBA 5527		<ul style="list-style-type: none"> ● VKHB 2177 ● VKHB 2303 	33116 TN9/QVT621 32310 TN9		VKN 504 VKN 502
NH/NR 6 - 9 tons		VKBA 5525		<ul style="list-style-type: none"> ● VKHB 2177 ● VKHB 2303 	33116 TN9/QVT621 32310 TN9	VKS 6285	VKN 504 VKN 502
HL/HLS 6,5 - 9 tons	1982-	VKBA 5527		<ul style="list-style-type: none"> ● VKHB 2177 ● VKHB 2303 	33116 TN9/QVT621 32310 TN9		VKN 504 VKN 502
	1982-	VKBA 5525		<ul style="list-style-type: none"> ● VKHB 2177 ● VKHB 2303 	33116 TN9/QVT621 32310 TN9	VKS 6285	VKN 504 VKN 502
ECO: H/R 6,5 - 9 tons, KH/KR 6,5 - 9 tons, NH/NR 6,5 - 9 tons	1993-	VKBA 5521		<ul style="list-style-type: none"> ● VKHB 2177 ● VKHB 2303 	33116 TN9/QVT621 32310 TN9	VKS 6250	VKN 504 VKN 515
ECO/ECO-MAXX, SH/SKH 8-9 tons		VKBA 5521		<ul style="list-style-type: none"> ● VKHB 2177 ● VKHB 2303 	33116 TN9/QVT621 32310 TN9	VKS 6250	VKN 504 VKN 515
ECO-Plus, 8-9 t		VKBA 5550		<ul style="list-style-type: none"> ● VKHB 2178 ● VKHB 2217 	33118 TN9/QVT621 33213 TN9/QVT621	VKS 6354	VKN 505 VKN 516
HL/HLS 10 - 12 tons		VKBA 5526		<ul style="list-style-type: none"> ● VKHB 2178 ● VKHB 2217 	33118 TN9/QVT621 33213 TN9/QVT621	VKS 6287	VKN 505 VKN 506
HL/HLS 10 - 12 ton		VKBA 5524		<ul style="list-style-type: none"> ● VKHB 2178 ● VKHB 2217 	33118 TN9/QVT621 33213 TN9/QVT621		VKN 505 VKN 506
ECO: H/R 10-12 tons, KH/KR 10-12 tons, NH/NR 10-12 tons	1993-	VKBA 5522		<ul style="list-style-type: none"> ● VKHB 2178 ● VKHB 2217 	33118 TN9/QVT621 33213 TN9/QVT621	VKS 6251	VKN 505 VKN 506
ECO/ECO-MAXX, SH/SKH 10-12 tons		VKBA 5522		<ul style="list-style-type: none"> ● VKHB 2178 ● VKHB 2217 	33118 TN9/QVT621 33213 TN9/QVT621	VKS 6251	VKN 505 VKN 516
ECO-Plus, 10-12 t		VKBA 5551		<ul style="list-style-type: none"> ● VKHB 2178 ● VKHB 2217 	33118 TN9/QVT621 33213 TN9/QVT621	VKS 6251	VKN 505 VKN 516

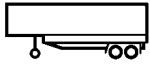

H/R 10-12 tons, KH/HR 10-12 tons	1982-	VKBA 5524	<ul style="list-style-type: none"> • VKHB 2178 • VKHB 2217 	33118 TN9/QVT621 33213 TN9/QVT621	VKN 505 VKN 506		
NH/NR 10-12 tons		VKBA 5526	<ul style="list-style-type: none"> • VKHB 2178 • VKHB 2217 	33118 TN9/QVT621 33213 TN9/QVT621	VKS 6287	VKN 505 VKN 506	
NR 13 - 14 tons			<ul style="list-style-type: none"> • VKHB 2031 • VKHB 2028 	32219 J2 33215/Q	VKS 6286		
FRUEHAUF							
Propar axle (P-series)		VKBA 5505	<ul style="list-style-type: none"> • VKHB 2227 • VKHB 2227 	HM 518445/410 HM 518445/410	VKS 6283	VKN 511 VKN 511	
SMB OA/VA	1991-99	VKBA 5523	<ul style="list-style-type: none"> • VKHB 2279 • VKHB 2279 	BT1B 639416 A/Q BT1B 639416 A/Q	VKS 6252	VKN 510 VKN 510	1)
	2000-		<ul style="list-style-type: none"> • VKHB 2279 • VKHB 2279 	BT1B 639416 A/Q BT1B 639416 A/Q	VKS 6364	VKN 510 VKN 510	2)
	2000-		<ul style="list-style-type: none"> • VKHB 2279 • VKHB 2279 	BT1B 639416 A/Q BT1B 639416 A/Q	VKS 6365	VKN 510 VKN 510	3)
	2000-		<ul style="list-style-type: none"> • VKHB 2279 • VKHB 2279 	BT1B 639416 A/Q BT1B 639416 A/Q	VKS 6366	VKN 510 VKN 510	4)
GIGANT (SAE)							
DH4 05506 3334	1999		<ul style="list-style-type: none"> • VKHB 2065 	33208/Q			
DH5/6 09010 3745, DH5/6 09010 4345	1999/1998		<ul style="list-style-type: none"> • VKHB 2326 • VKHB 2303 	33116/Q 33210 TN9			2)
DH6 10010 4345, DH6 10008 3745			<ul style="list-style-type: none"> • VKHB 2331 • VKHB 2051 	33118/Q 33213/Q			2)
GH4 05506 3010	06/1999		<ul style="list-style-type: none"> • VKHB 2065 	33208/Q			
GHK1 12010		VKBA 5397	<ul style="list-style-type: none"> • 				
GNV5 10010 3020	11/1996		<ul style="list-style-type: none"> • VKHB 2331 • VKHB 2051 	33118/Q 33213/Q			2)
GNV5 12010 3620	1996		<ul style="list-style-type: none"> • VKHB 2331 • VKHB 2051 	33118/Q 33213/Q			2)

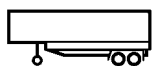

GIGANT (SAE) .../...

GNVH5 10010 3020,
GNVH5 10010 3620,
GNVH5 12010 3020,
GNVH5 12010 3620

- VKHB 2331 33118/Q
- VKHB 2051 33213/Q

2)

GNVH5 12010 4220 1999

- VKHB 2331 33118/Q
- VKHB 2051 33213/Q

GNVH5/6 09010 4218 1997

- VKHB 2326 33116/Q
- VKHB 2303 32310 TN9

1)
2)

GV 2001 10510 3020

- VKHB 2326 33116/Q
- VKHB 2326 33116/Q

2)

GV 2001 12010 3020

- VKHB 2331 33118/Q
- VKHB 2326 33116/Q

2)

GVH5 10008 3620, 1997
GVH5 10010 3020,
GVH5 10010 3620,
GVH5 10010 4220,
GVH5 12008 3620,
GVH5 12010 3020,
GVH5 12010 3620

- VKHB 2331 33118/Q
- VKHB 2051 33213/Q

2)

GVH5 12010 4220 1996

- VKHB 2331 33118/Q
- VKHB 2051 33213/Q

2)

GVH5/6 09010 4218 1999

- VKHB 2326 33116/Q
- VKHB 2303 32310 TN9

2)

GZV5 12010 4220 1999

- VKHB 2331 33118/Q
- VKHB 2051 33213/Q

2)

SH3 10510 3020, 1990/1995
SNH3 10510 3020

- VKHB 2026 32216 J2/Q
- VKHB 2026 32216 J2/Q

SV2 05506 3012 1989

- VKHB 2019 32211 J2/Q

SV2 06706 3015 1990

- VKHB 2284 32214 J2/Q

SV2 14010 4220 (340120)

- VKHB 2297 32220 J2
- VKHB 2030 32218 J2/Q

SV2 20010 4220 1998

- VKHB 2297 32220 J2

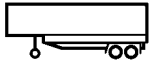

SV3 10508 3520
(340022)

- VKHB 2030 32218 J2/Q
- VKHB 2026 32216 J2/Q

SV3 10510 3020 1990
(340049, 340109,
340253)

- VKHB 2026 32216 J2/Q
- VKHB 2026 32216 J2/Q

SV3 12010 3020,
SV3 13010 3520
(340250)

- VKHB 2030 32218 J2/Q
- VKHB 2026 32216 J2/Q

5120/S32

- VKHB 2017 32210 J2/Q
- VKHB 2020 32208 J2/Q

5122/S33

- VKHB 2284 32214 J2/Q
-

5203/S44

- VKHB 2026 32216 J2/Q
- VKHB 2284 32214 J2/Q

5204/S44

- VKHB 2030 32218 J2/Q
- VKHB 2026 32216 J2/Q

5205/S44

- VKHB 2297 32220 J2
- VKHB 2030 32218 J2/Q

5206/S44, 5207R/S44

-
- VKHB 2030 32218 J2/Q

7103/S33

- VKHB 2026 32216 J2/Q
- VKHB 2284 32214 J2/Q

7104/S35

- VKHB 2030 32218 J2/Q
- VKHB 2026 32216 J2/Q

7121/S33

-
- VKHB 2019 32211 J2/Q

7404/S33

- VKHB 2026 32216 J2/Q
- VKHB 2026 32216 J2/Q

9164/S35

- VKHB 2030 32218 J2/Q
- VKHB 2026 32216 J2/Q

9303/S4420

- VKHB 2026 32216 J2/Q
- VKHB 2284 32214 J2/Q

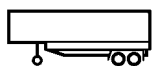

GIGANT (SAE) .../...

9304/54420

- VKHB 2030 32218 J2/Q
- VKHB 2026 32216 J2/Q

9404/535

- VKHB 2026 32216 J2/Q
- VKHB 2026 32216 J2/Q

KÄSSBOHRER

10 tons, 09-01.030,
09-01.062, 09-01.075,
09-01.077, 09-01.089,
09-01.093, 09-01.100

- VKHB 2030 32218 J2/Q
- VKHB 2026 32216 J2/Q

6,5 tons, 09-01.087,
09-01.088

- VKHB 2248 30218 J2
- VKHB 2204 30216 J2/Q

9 tons, 09-01.111,
09-01.112, 09-01.113,
09-01.114, 09-01.119,
09-01.121, 09-01.122

- VKHB 2248 30218 J2
- VKHB 2026 32216 J2/Q

MERCEDES-BENZ DISCOS

NR 5/10 DCL-9

VKBA 5548

- VKHB 2225 33217/Q
- VKHB 2002 32311 J2

VKS 6150

MERITOR (ROR)

TE 9000, TE 9300

VKBA 5528

VKA 4353

- VKHB 2298 33116 TN9/QCLNVB091
- VKHB 2299 32310 J2/QU4

VKS 6260

VKN 504
VKN 502

TM 22000, TM 22500,
TM 25000

VKBA 5504

VKA 4202

- VKHB 2029 HM 218248/W/2A/210/2A/Q
- VKHB 2051 33213/Q

VKS 6205

VKN 510
VKN 506

TM 33000

- VKHB 2297 32220 J2
- VKHB 2030 32218 J2/Q

1)

LM 9000

VKBA 5553

- VKHB 2315 BT1-0163/Q
- VKHB 2315 BT1-0163/Q

VKS 6205

MONTENEGRO

7,5 T

- VKHB 2080 32217 J2/Q

1)

8 T

- VKHB 2080 32217 J2/Q

2)

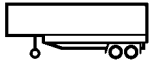

			<ul style="list-style-type: none"> • VKHB 2080 32217 J2/Q 		3)
8,5 T			<ul style="list-style-type: none"> • VKHB 2080 32217 J2/Q • VKHB 2080 32217 J2/Q 		4)
			<ul style="list-style-type: none"> • VKHB 2080 32217 J2/Q 		5)
9,5 T			<ul style="list-style-type: none"> • VKHB 2080 32217 J2/Q 		6)
			<ul style="list-style-type: none"> • VKHB 2080 32217 J2/Q 		7)
10,5 T			<ul style="list-style-type: none"> • VKHB 2080 32217 J2/Q • VKHB 2080 32217 J2/Q 		8)
11 T			<ul style="list-style-type: none"> • VKHB 2227 HM 518445/410 		9)
11,5 T			<ul style="list-style-type: none"> • VKHB 2227 HM 518445/410 		10)
13 T			<ul style="list-style-type: none"> • VKHB 2080 32217 J2/Q • VKHB 2080 32217 J2/Q 		11)
			<ul style="list-style-type: none"> • VKHB 2227 HM 518445/410 		12)
SAF					
Ebn 3140-6, Ebn 3130/12i			<ul style="list-style-type: none"> • VKHB 2061 33211/Q • VKHB 2182 33207/Q 		
Ebn 4040, ESN 4040			<ul style="list-style-type: none"> • VKHB 2198 30311 J2/Q • VKHB 2202 30307 J2/Q 		
Ebn 4530, Ebn 4535, Ebn 4540, Ebn 4540-6			<ul style="list-style-type: none"> • VKHB 2173 33212/Q • VKHB 2067 33209/Q 		
ESN 4540, ESN 5030, EZN 5030, RS 5030, WESN 5030, WEZN 5030			<ul style="list-style-type: none"> • VKHB 2283 30312 J2/Q • VKHB 2201 30309 J2/Q 		
ESN 5542			<ul style="list-style-type: none"> • VKHB 2288 32213 J2/Q 		

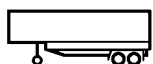

SAF .../...

				<ul style="list-style-type: none"> ● VKHB 2201 30309 J2/Q 			
ESN 6030, EZN 6030, WESN 6030, WEZN 6030, WEZN 6030/12"				<ul style="list-style-type: none"> ● VKHB 2304 30313 J2/Q ● VKHB 2201 30309 J2/Q 			
RZM 13130				<ul style="list-style-type: none"> ● VKHB 2030 32218 J2/Q ● VKHB 2003 32312 J2/Q 			
RBM 8442, RSM 8442, -11/1987 RSM 8442-8, RSM 11242, RZM 8442, 12/1987- RZM 8442-8, RZM11242,WRZM8442, WRZM 8442-8, WRZM 11242, RLBM 8442, RLSM 8442, RLSM 11242, WRLZM 8130, WRLZM 8435-8, WRLZM 8435-10, WRLZM 11030, WRLZM 11035-8, WRLZM 11035-10, WZRLZM 8130, WZRLZM 1103	VKBA 5507	VKA 4205		<ul style="list-style-type: none"> ● VKHB 2029 HM 218248/W/2A/210/2A/Q ● VKHB 2051 33213/Q ● VKHB 2029 HM 218248/W/2A/210/2A/Q ● VKHB 2051 33213/Q 	VKS 6249	VKN 510 VKN 506 VKN 510 VKN 506	
WRZM 8435-8, -01/1988 WRZM 8435-10, WRZM 11035-8, WRZM 11035-10 02/1988-	VKBA 5507	VKA 4205		<ul style="list-style-type: none"> ● VKHB 2029 HM 218248/W/2A/210/2A/Q ● VKHB 2051 33213/Q ● VKHB 2029 HM 218248/W/2A/210/2A/Q ● VKHB 2051 33213/Q 	VKS 6249	VKN 510 VKN 506 VKN 510 VKN 506	
RBM 8442/12				<ul style="list-style-type: none"> ● VKHB 2050 HM 215249/HM 215210 ● VKHB 2051 33213/Q 		VKN 506	
RSM 6242/12-8, RSM 6242/12-10, WRZM 6242, WRZM 6242-8				<ul style="list-style-type: none"> ● VKHB 2050 HM 215249/HM 215210 ● VKHB 2214 33113/Q 			
EBN 5535				<ul style="list-style-type: none"> ● VKHB 2214 33113/Q ● VKHB 2201 30309 J2/Q 			
RLSM 9042, -11/1995 RLSM 9042/20, RSM 6542, RSM 9042, RSM 9042/20	VKBA 5508			<ul style="list-style-type: none"> ● VKHB 2247 32924 ● VKHB 2247 32924 	VKS 6292	VKN 514 VKN 514	
RZM 16242, RZT 16242				<ul style="list-style-type: none"> ● VKHB 2212 32221 J2 ● VKHB 2072 32314 J2/Q 			



SMB



SMB OA/VA	1991-99	VKBA 5523	<ul style="list-style-type: none"> ● VKHB 2279 ● VKHB 2279 ● VKHB 2279 ● VKHB 2279 ● VKHB 2279 ● VKHB 2279 	BT1B 639416 A/Q	VKS 6252	VKN 510	1)
	2000-			BT1B 639416 A/Q		VKN 510	
	2000-			BT1B 639416 A/Q		VKN 510	2)
	2000-			BT1B 639416 A/Q		VKN 510	3)
	2000-			BT1B 639416 A/Q	VKS 6366	VKN 510	4)

TRAILOR

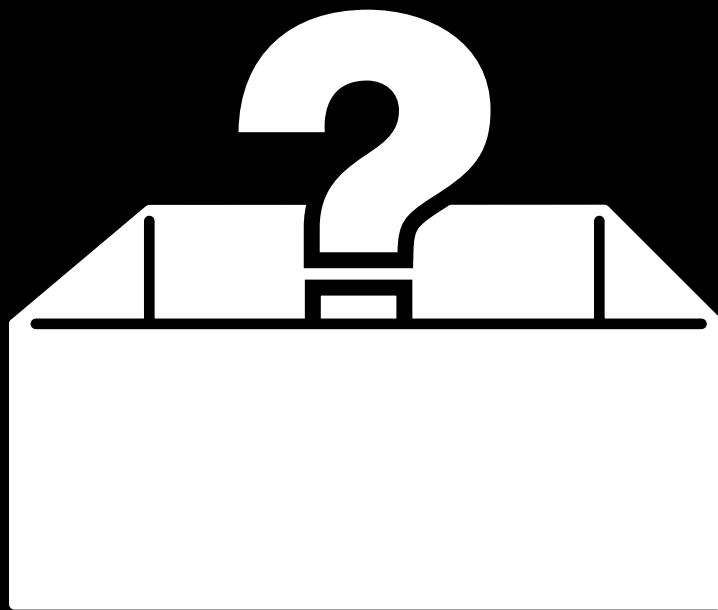

L 200; L 300 TM; L400 TEM		VKBA 5506	VKA 4204	<ul style="list-style-type: none"> ● VKHB 2226 ● VKHB 2205 	JM 718149 A/110/Q JM 515649/610/Q	VKS 6295	VKN 512 VKN 513
---------------------------	--	-----------	----------	--	--------------------------------------	----------	--------------------





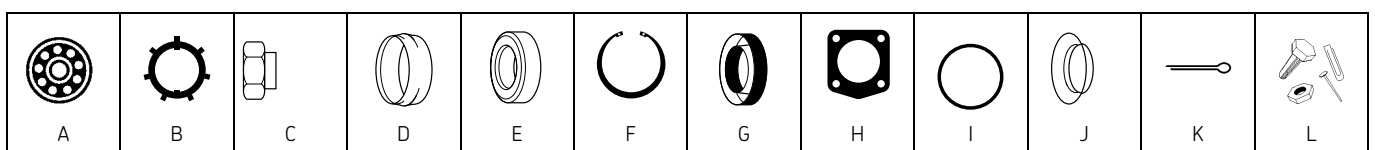







SMB OA/VA	1991-99	VKBA 5523	<ul style="list-style-type: none"> ● VKHB 2279 ● VKHB 2279 ● VKHB 2279 ● VKHB 2279 ● VKHB 2279 ● VKHB 2279 	BT1B 639416 A/Q	VKS 6252	VKN 510	1)
	2000-			BT1B 639416 A/Q		VKN 510	
	2000-			BT1B 639416 A/Q		VKN 510	2)
	2000-			BT1B 639416 A/Q		VKN 510	3)
	2000-			BT1B 639416 A/Q	VKS 6366	VKN 510	4)





	A	B	C	D	E	F	G	H	I	J	K	L		
VKA 4004							1		1				VOLVO	● ○
VKA 4026							1		1				VOLVO	○
VKA 4036							2	1					SCANIA	○
VKA 4038							1	1					SCANIA	○
VKA 4094							2	1					MERCEDES-BENZ	● ○
VKA 4095							1	2					MERCEDES-BENZ	● ○
VKA 4103		1					1						MERCEDES-BENZ	○
VKA 4110		1					1	1					MERCEDES-BENZ	○
VKA 4125							1	1					MAN	●
VKA 4169							2						FIAT IVECO	○
VKA 4171							2	1	1				FIAT IVECO	○
VKA 4202							1	1					RENAULT (RVI) / MERITOR (ROR)	○
VKA 4204							1	1					TRAILOR	
VKA 4205							1	1					SAF	
VKA 4207							1	1					SCANIA	● ○
VKA 4214							1			1			DAF	●
VKA 4216							1		2				DAF	○
VKA 4246							2		1				VOLVO	○
VKA 4265							1		2				VOLVO	● ○
VKA 4266							2						VOLVO	○
VKA 4321							2	1					KÄSSBOHRER/SETRA	●
VKA 4353							1	1					MERITOR (ROR)	
VKA 4369							2	1					SCANIA	○
VKBA 519	2						1						VOLKSWAGEN	●
VKBA 523	2						1				1		FORD	●
VKBA 528	2						1				1		FORD	●
VKBA 596	2						1						MERCEDES-BENZ	●
VKBA 741	2		1				1						FORD	●
VKBA 802	2		1				1						VOLKSWAGEN	●
VKBA 804	1		1				2						PEUGOET	●
VKBA 813	1		1				2						FIAT IVECO	●
VKBA 821	2	1					1	1					FIAT IVECO	○
VKBA 828	2						1						RENAULT (RVI)	○
VKBA 829	2		1				2						RENAULT (RVI)	●
VKBA 830	2		1				1						RENAULT (RVI)	○
VKBA 836	2		1				1						VOLKSWAGEN	●
VKBA 844	2		1				2						CITROEN / FIAT IVECO / PEUGOET	●
VKBA 845	2		1				1						CITROEN / FIAT IVECO / PEUGOET	○
VKBA 846	2		1				1						CITROEN / FIAT IVECO / PEUGOET	○
VKBA 847	2		1				1						RENAULT (RVI)	●
VKBA 848	1				1		2						RENAULT (RVI)	○
VKBA 849	1				1		1						RENAULT (RVI)	○
VKBA 908	1		1										RENAULT (RVI)	●
VKBA 909	1		1			1							RENAULT (RVI)	●





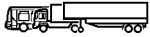



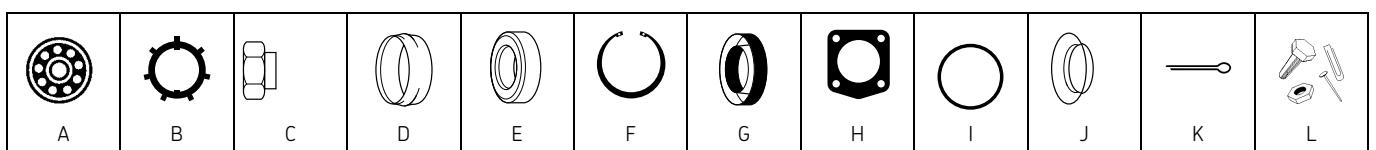







	A	B	C	D	E	F	G	H	I	J	K	L		
VKBA 910	2					1	2					1	VOLKSWAGEN	○
VKBA 911	2		1				1						VOLKSWAGEN	●
VKBA 912	2		1				1						VOLKSWAGEN	●
VKBA 922	1	1					1	1	1				FORD	○
VKBA 923	3	1					1						FORD	○
VKBA 957	1		1				1	1	1				FORD	○
VKBA 958	1		1				1	1	1				FORD	○
VKBA 959	3	1					2						FORD	○
VKBA 977	3		1				1						RENAULT (RVI)	○
VKBA 1312	1				1		1		1				CITROEN / PEUGOET	○
VKBA 1385	2		1				1	1					FIAT IVECO	●
VKBA 1386	2		1				1	1					FIAT IVECO	●
VKBA 1393	2						1						FIAT IVECO	○
VKBA 1394	2						1						FIAT IVECO	○
VKBA 1444	2		1				2						CITROEN / FIAT IVECO / PEUGOET	● ○
VKBA 1445	2		1				1						CITROEN / FIAT IVECO / PEUGOET	○
VKBA 1446	2		1				1						CITROEN / FIAT IVECO / PEUGOET	○
VKBA 1462	2		1				1						CITROEN / FIAT IVECO / PEUGOET	○
VKBA 1463	2		1				1						CITROEN / FIAT IVECO / PEUGOET	○
VKBA 1465	3						1				1		FORD	●
VKBA 1466	1						1		1				FORD	○
VKBA 1467	1						1						FORD	○
VKBA 1470	1	1	7	3				1					MERCEDES-BENZ	○
VKBA 1496	1				1		1		2				VOLKSWAGEN	○
VKBA 1497	1				1	1	1		2				VOLKSWAGEN	○
VKBA 3404	2		1	1			2						MERCEDES-BENZ	●
VKBA 3405	2	1					1						MERCEDES-BENZ	○
VKBA 3406	1		1			1						1	VOLKSWAGEN	● ○
VKBA 3407	3		1				1						RENAULT (RVI)	○
VKBA 3426	2	1					1						MERCEDES-BENZ	○
VKBA 3428	2		1				2						CITROEN / FIAT IVECO / PEUGOET	●
VKBA 3429	2		1				1						CITROEN / FIAT IVECO / PEUGOET	○
VKBA 3430	2		1				1						CITROEN / FIAT IVECO / PEUGOET	○
VKBA 3434	2						1			2			MERCEDES-BENZ / VOLKSWAGEN	●
VKBA 3435	1						2	1					MERCEDES-BENZ / VOLKSWAGEN	○
VKBA 3475	2	1					1						VOLKSWAGEN	○
VKBA 3486	1		1			1							MERCEDES-BENZ	● ○
VKBA 3500	1		1			1							OPEL / RENAULT (RVI)	●
VKBA 3501	1		1			1							OPEL / RENAULT (RVI)	○
VKBA 3508	2		1				1	1					FIAT IVECO	●
VKBA 3509	2		1				1	1					FIAT IVECO	●
VKBA 3551	1												FIAT IVECO	●
VKBA 3552	1												FIAT IVECO	○
VKBA 3553	1												FIAT IVECO	●

											
A	B	C	D	E	F	G	H	I	J	K	L

	A	B	C	D	E	F	G	H	I	J	K	L		
VKBA 3574	1		1			1							FIAT IVECO	○
VKBA 3588	1	1	1								1	5	FORD	●
VKBA 3589	1		1										FORD	○
VKBA 3590	1		1										FORD	○
VKBA 3613	1		1			1							OPEL / RENAULT (RVI) / RENAULT(RVI)	●
VKBA 3614	1		1			1						1	OPEL / RENAULT (RVI)	○
VKBA 3616	1		1										OPEL / RENAULT (RVI)	●
VKBA 3617	1		1			1							OPEL / RENAULT (RVI)	○
VKBA 3618	1		1										OPEL / RENAULT (RVI)	●
VKBA 3640	1		1			1						1	CITROEN / FIAT IVECO / PEUGOET	●
VKBA 3641	1		1			1						1	CITROEN / FIAT IVECO / PEUGOET	●
VKBA 3642	1		1			1							CITROEN / FIAT IVECO / PEUGOET	○
VKBA 3646	1		1										VOLKSWAGEN	● ○
VKBA 3648	1		1										RENAULT (RVI)	●
VKBA 3654	1		1										FORD	○
VKBA 3655	1		1										FORD	○
VKBA 3662	1					1							FIAT IVECO	●
VKBA 3663	1												FIAT IVECO	●
VKBA 3664	1								1				FIAT IVECO	○
VKBA 3679	1		1			1							CITROEN	○
VKBA 5025	2						1						MERCEDES-BENZ	●
VKBA 5026	2						1						MERCEDES-BENZ	●
VKBA 5028	2						1						MERCEDES-BENZ	●
VKBA 5038	2						2	1					MERCEDES-BENZ	● ○
VKBA 5039	2						1	1					MERCEDES-BENZ	●
VKBA 5048	2	1					1						MERCEDES-BENZ	○
VKBA 5052	2	1					1	1					MERCEDES-BENZ	○
VKBA 5056	2	1					1	1					MERCEDES-BENZ	○
VKBA 5064	2						1	1					SCANIA	● ○
VKBA 5067	2						2	1					SCANIA	○
VKBA 5099	4						1		1				VOLVO	● ○
VKBA 5101	3						2						VOLVO	○
VKBA 5124	2						1		1				VOLVO	● ○
VKBA 5150	2						1						MAN	○
VKBA 5160	2						2	4	1				MAN	○
VKBA 5162	2						1						MAN	● ○
VKBA 5163	2						1						MAN	○
VKBA 5230	2						1						DAF	●
VKBA 5240	3						1						DAF	●
VKBA 5262	3						2		1				VOLVO	○
VKBA 5265	2						1						MAN	●
VKBA 5274	2						1						FIAT IVECO	○
VKBA 5285	2						1		2				VOLVO	● ○
VKBA 5308	1								1				RENAULT (RVI)	● ○



	A	B	C	D	E	F	G	H	I	J	K	L		
VKBA 5314	1								1				SCANIA	● ○
VKBA 5343	2						1						FIAT IVECO	● ○
VKBA 5369	2						1						MERCEDES-BENZ	○
VKBA 5370	2						1						MERCEDES-BENZ	○
VKBA 5375	2						3	1					MERCEDES-BENZ	● ○
VKBA 5377	1		1										MAN	● ○
VKBA 5397	1												FIAT IVECO / GIGANT (SAE)	○
VKBA 5401	2						1						MERCEDES-BENZ	○
VKBA 5407	1								1				RENAULT (RVI)	●
VKBA 5408	1												MAN	○
VKBA 5409	1												FIAT IVECO	○
VKBA 5502	2						2						BPW	
VKBA 5504	2						1	1					RENAULT (RVI) / MERITOR (ROR)	○
VKBA 5505	4						1		1				FRUEHAUF	
VKBA 5506	3						1	1					TRAILOR	
VKBA 5507	2						1	1					SAF	
VKBA 5508	2						1	1					SAF	
VKBA 5521	2	1				3	1			2	1		BPW	
VKBA 5522	2					1	2			1	1		BPW	
VKBA 5523	4						1						FRUEHAUF / SMB / TRAILOR	
VKBA 5524	2						2			1	1		BPW	
VKBA 5525	2						2				1		BPW	
VKBA 5526	2						1			1	1		BPW	
VKBA 5527	2						3				1		BPW	
VKBA 5528	2						1	1					MERITOR (ROR)	
VKBA 5548	2						1	1					MERCEDES-BENZ	
VKBA 5550	2				1	2	3						BPW	
VKBA 5551	2				1	2	3		1				BPW	
VKBA 5553	2						1						MERITOR (ROR)	

											
A	B	C	D	E	F	G	H	I	J	K	L

$$VKBA = VKHB + VKHB + VKA/VKS$$

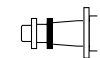

VKBA 5025		VKHB 2056	VKHB 2057	VKS 6299	
VKBA 5026		VKHB 2059	VKHB 2007	VKS 6159	
VKBA 5028		VKHB 2061	VKHB 2007	VKS 6148	
VKBA 5038	VKA 4094	VKHB 2071	VKHB 2070	VKS 6158	VKS 6146
VKBA 5039		VKHB 2072	VKHB 2070	VKS 6150	
VKBA 5048	VKA 4103	VKHB 2155	VKHB 2156	VKS 6172	
VKBA 5052		VKHB 2082	VKHB 2028	VKS 6154	
VKBA 5056	VKA 4110	VKHB 2124	VKHB 2158	VKS 6176	
VKBA 5064		VKHB 2003	VKHB 2004	VKS 6108	
VKBA 5067	VKA 4036	VKHB 2029	VKHB 2029	VKS 6111	VKS 6105
VKBA 5099		VKHB 2013	VKHB 2014	VKS 6114	
VKBA 5101	VKA 4266	VKHB 2042	VKHB 2043	VKS 6135	VKS 6298
VKBA 5124	VKA 4004	VKHB 2024	VKHB 2036	VKS 6134	
VKBA 5150		VKHB 2174	VKHB 2175	VKS 6192	
VKBA 5160		VKHB 2163	VKHB 2164	VKS 6183	VKS 6181
VKBA 5162		VKHB 2132	VKHB 2070	VKS 6182	
VKBA 5163		VKHB 2146	VKHB 2082	VKS 6189	
VKBA 5230		VKHB 2232	VKHB 2070	VKS 6333	
VKBA 5240		VKHB 2237	VKHB 2238		
VKBA 5262	VKA 4246	VKHB 2042	VKHB 2043	VKS 6135	VKS 6298
VKBA 5265		VKHB 2240	VKHB 2018	VKS 6296	
VKBA 5274		VKHB 2209	VKHB 2209	VKS 6326	
VKBA 5285	VKA 4265	VKHB 2024	VKHB 2036	VKS 6134	
VKBA 5343		VKHB 2024	VKHB 2252	VKS 6326	
VKBA 5369		VKHB 2162	VKHB 2306	VKS 6334	
VKBA 5370		VKHB 2163	VKHB 2165	VKS 6334	
VKBA 5375		VKHB 2280	VKHB 2003	VKS 6315	VKS 6150
VKBA 5401		VKHB 2163	VKHB 2329	VKS 6353	VKS 6146
VKBA 5502		VKHB 2028	VKHB 2303		
VKBA 5504	VKA 4202	VKHB 2029	VKHB 2051	VKS 6205	
VKBA 5505		VKHB 2227	VKHB 2227	VKS 6283	
VKBA 5506	VKA 4204	VKHB 2226	VKHB 2205	VKS 6295	
VKBA 5507	VKA 4205	VKHB 2029	VKHB 2051	VKS 6249	
VKBA 5508		VKHB 2247	VKHB 2247	VKS 6292	
VKBA 5521		VKHB 2177	VKHB 2303	VKS 6250	
VKBA 5522		VKHB 2178	VKHB 2217	VKS 6251	
VKBA 5523		VKHB 2279	VKHB 2279	VKS 6252	
VKBA 5524		VKHB 2178	VKHB 2217		
VKBA 5525		VKHB 2177	VKHB 2303	VKS 6285	
VKBA 5526		VKHB 2178	VKHB 2217	VKS 6287	
VKBA 5527		VKHB 2177	VKHB 2303		
VKBA 5528	VKA 4353	VKHB 2298	VKHB 2299	VKS 6260	
VKBA 5548		VKHB 2225	VKHB 2002	VKS 6150	
VKBA 5550		VKHB 2178	VKHB 2217	VKS 6354	
VKBA 5551		VKHB 2178	VKHB 2217	VKS 6251	
VKBA 5553		VKHB 2315	VKHB 2315	VKS 6205	

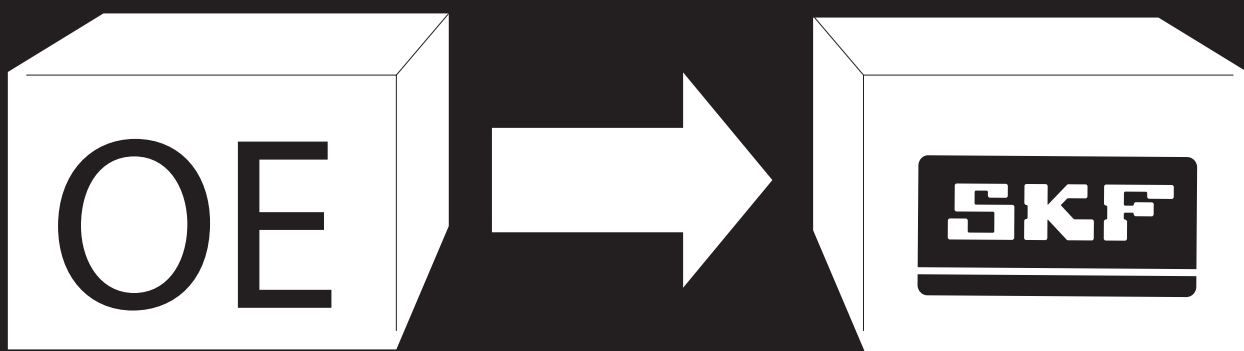

BPW	300
CITROËN	300
DAF	300
FIAT / IVECO	300
FORD	301
FRUEHAUF	301
KÄSSBOHRER	301
MAN	301
MERCEDES BENZ	302

MERITOR (ROR)	303
OPEL	303
PEUGEOT	303
RENAULT / RVI	303
SAF	304
SCANIA	304
TRAILOR	305
VOLVO	305
VW	305

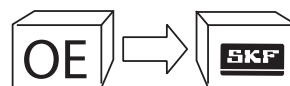
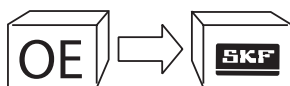
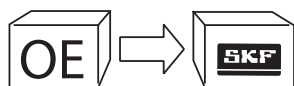
**BPW**

02.5664.26.57	VKS 6285
02.5664.46.57	VKS 6287
02.5664.55.64	VKS 6250
02.5664.56.64	VKS 6251
02.5664.57.00	VKS 6250
02.5664.58.00	VKS 6251
02.5664.64.57	VKS 6286
02.5664.68.00	VKS 6354
02.6401.25.00	VKHB 2189
02.6402.65.00	VKHB 2304
02.6405.95.00	VKHB 2031
02.6406.45.00	VKHB 2004
02.6406.50.00	VKHB 2303
02.6406.70.00	VKHB 2072
02.6407.40.00	VKHB 2065
02.6407.45.01	VKHB 2067
02.6407.65.00	VKHB 2051
02.6407.65.00	VKHB 2217
02.6407.67.00	VKHB 2217
02.6407.75.00	VKHB 2028
02.6407.85.00	VKHB 2225
02.6408.80.00	VKHB 2177
02.6408.80.00	VKHB 2298
02.6408.90.00	VKHB 2178
02.6408.92.00	VKHB 2178
02.6410.22.00	VKHB 2217
02.6410.23.00	VKHB 2178
02.6410.24.00	VKHB 2177
02.6410.25.00	VKHB 2303
02.6410.27.00	VKHB 2072
02.6410.28.00	VKHB 2031
02.6410.29.00	VKHB 2028
09.02.6407.65.00	VKHB 2029
09.801.02.19.0	VKBA 5525
09.801.02.20.0	VKBA 5526
09.801.02.24.0	VKBA 5527
09.801.02.33.0	VKBA 5521
09.801.02.34.0	VKBA 5522
09.801.02.72.0	VKBA 5521
09.801.02.98.0	VKBA 5524
09.801.06.26.0	VKBA 5550
09.801.06.27.0	VKBA 5551

CITROËN

3350.21	VKBA 1444
3350.24	VKBA 3428
3350.25	VKBA 3429
3350.26	VKBA 3430
3350.29	VKBA 1444
3350.30	VKBA 3428
3730.22	VKHB 2016
95 555 853	VKBA 813
ZF05996248	VKHB 2016

DAF

0140896	VKHB 2004
---------	-----------

0174592
0174595
0190069
0221664

0266487
0266488
0275823
0283684
0292766

0556289
0556290
0640618
0692180
0699117

10271961
10901093
10901094
1238034
1327603

13H6552
174592
174595
174595
190069

202825
254912
260204
260724
266487

266488
283686
292766
325321
325333

325333
4805
490881
490882
491899

491901
491966
494535
494536
495520

614943
626875
631780
636820
676987

676988
678157
AJU 1901
AMPA012
AMPB 584

RTC 3412
RTC 3427
RTC 3436
UKC 4805

VKHB 2043
VKHB 2141
VKS 6171
VKHB 2222

VKHB 2147
VKHB 2146
VKHB 2002
VKHB 2236
VKS 6180

VKHB 2070
VKHB 2232
VKHB 2157
VKHB 2299
VKHB 2306

VKHB 2333
VKHB 2137
VKHB 2332
VKS 6333
VKHB 2231

VKHB 2243
VKHB 2043
VKHB 2042
VKHB 2141
VKS 6171

VKHB 2089
VKHB 2137
VKHB 2132
VKHB 2143
VKHB 2147

VKHB 2146
VKHB 2004
VKS 6180
VKS 6170
VKHB 2142

VKHB 2221
VKHB 2238
VKS 6267
VKHB 2034
VKHB 2016

VKS 6266
VKHB 2242
VKHB 2239
VKHB 2246
VKHB 2241

VKHB 2068
VKHB 2070
VKHB 2140
VKHB 2067
VKHB 2082

VKHB 2145
VKS 6140
VKS 6358
VKHB 2161
VKS 6357

VKHB 2239
VKHB 2237
VKHB 2246
VKHB 2238

FIAT / IVECO

1101597	VKHB 2060
1102042	VKHB 2282
1102857	VKHB 2168
1102858	VKHB 2248
1102859	VKHB 2283
1102860	VKHB 2216
1102864	VKHB 2215
1103142	VKHB 2284
1103360	VKHB 2216
1103771	VKHB 2033
1104922	VKHB 2160
1104923	VKHB 2082
1109968	VKHB 2334
1109981	VKHB 2201
1110002	VKHB 2020
1110016	VKHB 2063
1110018	VKHB 2004
1110019	VKHB 2004
1110020	VKHB 2070
1125929	VKHB 2019
1126121	VKHB 2204
1126887	VKHB 2001
1133049	VKHB 2046
1384728	VKHB 2200
1905027	VKHB 2124
1905172	VKHB 2211
1905216	VKHB 2154
1905219	VKHB 2253
1905220	VKHB 2209
1905221	VKHB 2250
1905222	VKHB 2249
1905236	VKHB 2339
1905252	VKHB 2190
1905261	VKHB 2065
1905300	VKHB 2285
1905350	VKHB 2031
1905351	VKHB 2297
1905487	VKBA 5397
2475977	VKS 6214
26800040	VKHB 2204
26800140	VKHB 2020
26800160	VKHB 2017
26800170	VKHB 2019
26800230	VKHB 2080
26800250	VKHB 2031
26800270	VKHB 2212
26800330	VKHB 2262
26800350	VKHB 2202
26800390	VKHB 2003
26800580	VKHB 2001
26800600	VKHB 2070
26800610	VKHB 2002
26800620	VKHB 2198
26800640	VKHB 2072
38510549	VKS 6105
40001903	VKS 6221
40001933	VKS 6216
40002850	VKS 6215
40002851	VKS 6215
40002853	VKS 6215

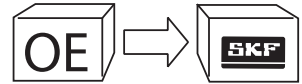
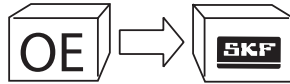
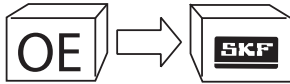

40003723
 40003733
 40100043
 40100110
 40100113
 40100443
 40100670
 40102143
 40102273
 40102321
 4023140
 4096587
 41800341
 41800342
 42101665
 42492259
 4330647
 4330648
 4470124
 4540025
 4690299
 4711928
 5996248
 5996253
 60115335
 60141947
 7074945
 7160360
 7160361
 7160953
 7162191
 7162944
 7164410
 7164487
 7164543
 7164544
 7164705
 7165686
 7166346
 7169934
 7169935
 71714452
 71714454
 7172951
 7174945
 7174945
 7174946
 7177004
 7183075
 7183074
 7982089
 8190538
 8194950
 8194959
 8582739
 8582740
 86014686
 93160832
 93803934
 93803935
 93806250
 9381 0034

VKS 6225
 VKS 6218
 VKS 6211
 VKS 6216
 VKS 6211
 VKS 6225
 VKS 6218
 VKS 6326
 VKS 6316
 VKS 6330
 VKHB 2054
 VKHB 2151
 VKHB 2162
 VKHB 2225
 VKHB 2286
 VKHB 2061
 VKHB 2275
 VKHB 2266
 VKHB 2267
 VKHB 2013
 VKHB 2214
 VKHB 2203
 VKHB 2016
 VKHB 2268
 VKHB 2169
 VKHB 2199
 VKHB 2178
 VKHB 2059
 VKHB 2173
 VKHB 2205
 VKHB 2060
 VKHB 2170
 VKHB 2154
 VKHB 2199
 VKHB 2210
 VKHB 2080
 VKHB 2208
 VKHB 2061
 VKHB 2137
 VKHB 2255
 VKHB 2182
 VKBA 3430
 VKBA 3429
 VKHB 2252
 VKHB 2178
 VKHB 2331
 VKHB 2051
 VKHB 2212
 VKBA 5397
 VKBA 5409
 VKHB 2299
 VKHB 2160
 VKHB 2243
 VKHB 2186
 VKHB 2065
 VKHB 2179
 VKS 6239
 VKS 6180
 VKHB 2262
 VKHB 2294
 VKHB 2262
 VKBA 3553

99041057
 99041067
 9980734
 9980735
 9980739
 9980740
 99825736
 9985454

FORD

0 634 048
 1 053 115
 1 201 300
 1 201 303
 1 201 304
 1 318 151
 1 318 154
 5 007 028
 5 007 029
 5 007 036
 5 007 041
 5 010 762
 5 015 586
 5 015 587
 5 015 650
 5 025 899
 5 025 900
 5 025 901
 A 790X 1200 BA
 A710 1215 CA
 A710X 1200 KA
 A790X 1242 DA
 A790X 1242 FA
 A790X 1242 FA
 TAJAA 1238 A

FRUEHAUF

A.JA 0564.001
 A.JA 0813.001
 M 003168
 M00-3125
 M200021-01
 M200021-02
 M200021-03
 T6014000T000
 T6015000D000

KÄSSBOHRER

4.753.656.000
 4.753.656.000E
 6.691.128.000
 6.691.130.000
 6.691.159.000
 6.691.161.000
 6.691.168.000
 6.691.383.000
 6.691.383.000E

VKHB 2030
 VKHB 2298
 VKHB 2246
 VKHB 2239
 VKHB 2276
 VKHB 2258
 VKBA 3551
 VKHB 2298
 VKHB 2246
 VKBA 1465
 VKBA 3588
 VKBA 3590
 VKBA 3589
 VKBA 3654
 VKBA 3655
 VKBA 528
 VKBA 523
 VKBA 922
 VKBA 923
 VKBA 741
 VKBA 957
 VKBA 958
 VKBA 959
 VKBA 1465
 VKBA 1466
 VKBA 1467
 VKHB 2088
 VKHB 2310
 VKHB 2309
 VKHB 2311
 VKHB 2142
 VKHB 2221
 VKHB 2041
 VKS 6283
 VKHB 2227
 VKHB 2279
 VKS 6252
 VKS 6365
 VKS 6366
 VKS 6364
 VKHB 2226
 VKHB 2205
 VKS 6259
 VKS 6259
 VKHB 2204
 VKHB 2248
 VKHB 2026
 VKHB 2030
 VKHB 2004
 VKHB 2071
 VKHB 2071

6.691.450.000
 6.691.453.000
 MAN
 06.32480.1000
 06.32480.1200
 06.32489.0002
 06.32489.0009
 06.32489.0012
 06.32489.0019
 06.32489.0021
 06.32489.0032
 06.32489.0044
 06.32489.0045
 06.32489.0051
 06.32489.0060
 06.32489.0063
 06.32489.0066
 06.32489.0071
 06.32489.0072
 06.32489.0114
 06.32499.0005
 06.32499.0013
 06.32499.0016
 06.32499.0036
 06.32499.0040
 06.32499.0043
 06.32499.0044
 06.32499.0046
 06.32499.0058
 06.32499.0063
 06.32499.0079
 06.32499.0081
 06.32499.0096
 06.32499.0097
 06.32499.0103
 06.32499.0108
 06.32499.0126
 06.32499.0127
 06.32499.0131
 06.32499.0155
 06.32499.0175
 06.32499.0188
 06.34299.0066
 06.56281.0605
 06.56289.0045
 06.56289.0052
 06.56289.0065
 06.56289.0184
 06.56289.0309
 06.56289.0315
 06.56289.0320
 06.56289.0321
 06.56289.0323
 06.56289.0324
 06.56289.0325
 06.56289.0334
 06.56289.0335
 06.56289.0365
 06.56289.0371

VKHB 2281
 VKHB 2160
 VKHB 2282
 VKHB 2169
 VKHB 2065
 VKHB 2172
 VKHB 2161
 VKHB 2168
 VKHB 2248
 VKHB 2164
 VKHB 2067
 VKHB 2173
 VKHB 2170
 VKHB 2169
 VKHB 2216
 VKHB 2293
 VKHB 2160
 VKHB 2240
 VKHB 2161
 VKHB 2033
 VKHB 2004
 VKHB 2070
 VKHB 2082
 VKHB 2222
 VKHB 2132
 VKHB 2163
 VKHB 2165
 VKHB 2046
 VKHB 2020
 VKHB 2018
 VKHB 2132
 VKHB 2162
 VKHB 2165
 VKHB 2137
 VKHB 2214
 VKHB 2146
 VKHB 2146
 VKHB 2222
 VKHB 2163
 VKHB 2179
 VKHB 2146
 VKHB 2016
 VKS 6182
 VKHB 2173
 VKS 6194
 VKS 6183
 VKS 6192
 VKS 6189
 VKS 6182
 VKS 6296
 VKS 6327
 VKS 6329
 VKS 6182
 VKS 6302
 VKS 6181
 VKS 6183
 VKS 6194
 VKS 6334

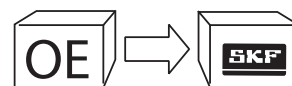
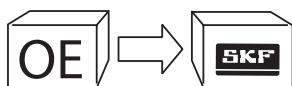
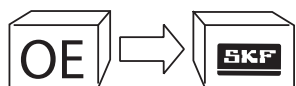

06.56289.0385	VKS 6328	001 980 26 02	VKHB 2161	003 981 37 05	VKHB 2051
06.56289.0386	VKS 6189	001 980 27 02	VKHB 2028	003 981 39 05	VKHB 2065
81.93420.0072	VKHB 2068			003 981 41 05	VKHB 2214
81.93420.0077	VKHB 2065	001 980 29 02	VKHB 2151	003 981 43 05	VKHB 2156
		001 980 62 02	VKHB 2153	003 981 45 05	VKHB 2165
81.93420.0131	VKHB 2299	001 980 66 02	VKHB 2124		
81.93420.0162	VKHB 2174	001 980 67 02	VKHB 2158	003 981 51 05	VKHB 2161
81.93420.0163	VKHB 2175	001 981 05 05	VKHB 2075	003 981 52 05	VKHB 2066
81.93420.0285	VKHB 2320			003 981 53 05	VKHB 2067
81.93420.0288	VKBA 5377	001 981 15 05	VKHB 2016	003 981 56 05	VKHB 2066
		001 981 29 05	VKHB 2070	003 981 57 05	VKHB 2067
81.93420.0342	VKBA 5408	001 981 38 05	VKHB 2075		
81.93420.6001	VKHB 2075	001 981 45 05	VKHB 2083	003 981 64 05	VKHB 2063
81.93420.6016	VKHB 2044	001 981 48 05	VKHB 2033	003 981 72 05	VKHB 2065
81.96503.0161	VKS 6192			003 981 74 05	VKHB 2051
81935010028	VKHB 2243	001 981 56 05	VKHB 2063	003 981 83 05	VKHB 2068
		001 981 61 05	VKHB 2016	003 981 85 05	VKHB 2066
87.52330.0600	VKHB 2019	001 981 64 05	VKHB 2306		
		001 981 65 05	VKHB 2016	003 981 86 05	VKHB 2082
		001 981 70 05	VKHB 2063	003 981 95 05	VKHB 2057
				003 981 96 05	VKHB 2056
		001 981 74 05	VKHB 2070	004 981 07 05	VKHB 2163
		001 981 82 02	VKHB 2070	004 981 09 05	VKHB 2163
		001 981 83 05	VKHB 2317		
		001 981 84 05	VKHB 2019	004 981 10 05	VKHB 2165
		001 981 86 05	VKHB 2019	004 981 17 05	VKHB 2170
				004 981 20 05	VKHB 2323
		001 981 87 05	VKHB 2007	004 981 21 05	VKHB 2164
		001 981 89 05	VKHB 2017	004 981 34 05	VKHB 2064
		001 981 90 05	VKHB 2058		
		001 981 95 05	VKHB 2007	004 981 38 05	VKHB 2064
		002 981 00 05	VKHB 2041	004 981 42 05	VKHB 2068
				004 981 46 05	VKHB 2041
		002 981 05 05	VKHB 2075	004 981 47 05	VKHB 2041
		002 981 12 05	VKHB 2191	004 981 48 05	VKHB 2041
		002 981 13 05	VKHB 2060		
		002 981 16 05	VKHB 2200	004 981 49 05	VKHB 2164
		002 981 17 05	VKHB 2080	004 981 64 05	VKHB 2061
				004 981 65 05	VKHB 2061
		002 981 18 05	VKHB 2080	004 981 67 05	VKHB 2061
		002 981 19 05	VKHB 2017	004 981 68 05	VKHB 2065
		002 981 20 05	VKHB 2058		
		002 981 22 05	VKHB 2017	004 981 98 05	VKHB 2072
		002 981 24 05	VKHB 2019	004 981 99 05	VKHB 2072
				004 997 18 47	VKS 6150
		002 981 28 05	VKHB 2054	004 997 77 45	VKS 6151
		002 981 54 05	VKHB 2161	005 981 00 05	VKHB 2072
		002 981 55 05	VKHB 2081		
		002 981 56 05	VKHB 2081	005 981 21 05	VKHB 2163
		002 981 66 05	VKHB 2060	005 981 31 05	VKHB 2071
				005 981 41 05	VKHB 2067
		002 981 79 05	VKHB 2068	005 981 44 05	VKHB 2156
		002 981 82 05	VKHB 2318	005 981 49 05	VKHB 2162
		002 981 86 05	VKHB 2028		
		002 981 89 05	VKHB 2028	005 981 53 05	VKHB 2017
		002 981 90 05	VKHB 2082	005 981 66 05	VKHB 2154
				005 981 69 05	VKHB 2044
		002 981 92 02	VKHB 2076	005 981 83 05	VKHB 2158
		002 981 95 05	VKHB 2155	005 981 84 05	VKHB 2124
		002 997 65 47	VKS 6146		
		002 997 84 47	VKS 6148	005 981 85 05	VKHB 2124
		002 997 85 47	VKS 6148	005 981 86 05	VKHB 2158
				005 981 95 05	VKHB 2154
		003 981 00 05	VKHB 2155	005 981 98 05	VKHB 2154
		003 981 10 05	VKHB 2057	005 981 99 05	VKHB 2158
		003 981 11 05	VKHB 2056		
		003 981 15 05	VKHB 2057	005 997 44 46	VKS 6176
		003 981 16 05	VKHB 2056	006 981 01 05	VKHB 2124
				006 981 06 05	VKHB 2026
		003 981 25 05	VKHB 2160	006 981 07 05	VKHB 2063
		003 981 26 05	VKHB 2162	006 981 08 05	VKHB 2002
		003 981 27 05	VKHB 2160		
		003 981 28 05	VKHB 2162	006 981 42 05	VKHB 2201
		003 981 32 05	VKHB 2222	006 981 45 05	VKHB 2191

MERCEDES BENZ

000 350 10 35	VKS 6350	001 981 74 05	VKHB 2070	003 981 86 05	VKHB 2082
000 980 50 02	VKHB 2055	001 981 82 02	VKHB 2070	003 981 95 05	VKHB 2057
000 980 54 02	VKHB 2055	001 981 83 05	VKHB 2070	003 981 96 05	VKHB 2056
000 980 55 02	VKHB 2055	001 981 84 05	VKHB 2317	004 981 07 05	VKHB 2163
000 980 72 02	VKHB 2076	001 981 86 05	VKHB 2019	004 981 09 05	VKHB 2163
000 980 74 02	VKHB 2076	001 981 87 05	VKHB 2019	004 981 10 05	VKHB 2165
000 980 75 02	VKHB 2059	001 981 89 05	VKHB 2019	004 981 17 05	VKHB 2170
000 980 96 02	VKHB 2082	001 981 90 05	VKHB 2019	004 981 20 05	VKHB 2323
000 980 97 02	VKHB 2162	001 981 95 05	VKHB 2017	004 981 21 05	VKHB 2164
000 981 03 05	VKHB 2026	002 981 00 05	VKHB 2058	004 981 34 05	VKHB 2064
000 981 22 05	VKHB 2080	002 981 05 05	VKHB 2007	004 981 38 05	VKHB 2064
000 981 24 01	VKHB 2026	002 981 12 05	VKHB 2017	004 981 42 05	VKHB 2068
000 981 33 05	VKHB 2019	002 981 13 05	VKHB 2058	004 981 46 05	VKHB 2041
000 981 36 05	VKHB 2017	002 981 16 05	VKHB 2007	004 981 47 05	VKHB 2041
000 981 41 05	VKHB 2079	002 981 17 05	VKHB 2041	004 981 48 05	VKHB 2041
000 981 46 05	VKHB 2328	002 981 18 05	VKHB 2075	004 981 49 05	VKHB 2164
000 981 56 05	VKHB 2041	002 981 19 05	VKHB 2191	004 981 64 05	VKHB 2061
000 981 72 05	VKHB 2026	002 981 20 05	VKHB 2060	004 981 65 05	VKHB 2061
000 981 74 05	VKHB 2033	002 981 22 05	VKHB 2200	004 981 67 05	VKHB 2061
000 981 75 05	VKHB 2083	002 981 24 05	VKHB 2080	004 981 68 05	VKHB 2065
000 981 79 05	VKHB 2083	002 981 28 05	VKHB 2017	004 981 98 05	VKHB 2072
000 981 83 02	VKHB 2059	002 981 54 05	VKHB 2058	004 981 99 05	VKHB 2072
000 981 84 05	VKHB 2059	002 981 55 05	VKHB 2017	004 997 18 47	VKS 6150
000 981 84 05	VKHB 2033	002 981 56 05	VKHB 2058	004 997 77 45	VKS 6151
000 981 90 02	VKHB 2060	002 981 55 05	VKHB 2017	005 981 00 05	VKHB 2072
000 981 90 05	VKHB 2019	002 981 56 05	VKHB 2058		
		002 981 66 05	VKHB 2017	005 981 21 05	VKHB 2163
				005 981 31 05	VKHB 2071
		002 981 79 05	VKHB 2019	005 981 41 05	VKHB 2067
		002 981 82 05	VKHB 2054	005 981 44 05	VKHB 2156
		002 981 86 05	VKHB 2161	005 981 49 05	VKHB 2162
		002 981 89 05	VKHB 2081		
		002 981 90 05	VKHB 2081	005 981 53 05	VKHB 2017
			VKHB 2060	005 981 66 05	VKHB 2154
		002 981 92 02	VKHB 2060	005 981 69 05	VKHB 2044
		002 981 95 05	VKHB 2076	005 981 83 05	VKHB 2158
		002 997 65 47	VKHB 2155	005 981 84 05	VKHB 2124
		002 997 84 47	VKS 6146		
		002 997 85 47	VKS 6148	005 981 85 05	VKHB 2124
			VKS 6148	005 981 86 05	VKHB 2158
		003 981 00 05		005 981 95 05	VKHB 2154
		003 981 10 05	VKHB 2155	005 981 98 05	VKHB 2154
		003 981 11 05	VKHB 2057	005 981 99 05	VKHB 2158
		003 981 15 05	VKHB 2056		
		003 981 16 05	VKHB 2057	005 997 44 46	VKS 6176
			VKHB 2056	006 981 01 05	VKHB 2124
		003 981 25 05	VKHB 2056	006 981 06 05	VKHB 2026
		003 981 26 05	VKHB 2160	006 981 07 05	VKHB 2063
		003 981 27 05	VKHB 2162	006 981 08 05	VKHB 2002
		003 981 28 05	VKHB 2160		
		003 981 32 05	VKHB 2162	006 981 42 05	VKHB 2201
			VKHB 2160	006 981 45 05	VKHB 2191
			VKHB 2162		
			VKHB 2222		

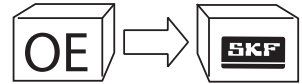
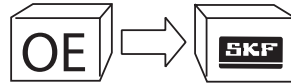
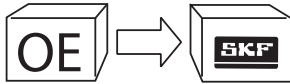

006 981 47 05
 006 981 51 05
 006 981 52 05
 006 981 56 05
 006 981 59 05
 006 981 62 05
 006 981 63 05
 006 981 69 05
 006 981 74 05
 006 981 82 05
 006 981 97 05
 006 981 99 05
 006 997 05 46
 006 997 21 47
 007 981 00 05
 007 981 04 05
 007 981 14 05
 007 981 25 05
 007 981 57 05
 007 981 76 05
 007 997 36 46
 008 981 34 05
 008 981 53 05
 008 981 83 05
 008 981 84 05
 008 981 95 05
 009 981 08 05
 009 981 41 05
 009 981 43 05
 009 981 60 05
 009 981 81 05
 009 981 93 05
 009 997 67 47
 009 997 92 47
 010 981 93 05
 010 997 01 47
 010 997 24 47
 010 997 79 47
 010 997 84 47
 010 997 86 47
 010 997 87 47
 011 981 68 05
 011 981 69 05
 011 997 25 46
 011 997 54 46
 012 981 32 05
 012 981 40 05
 012 997 11 47
 012 997 67 47
 012 997 91 47
 013 981 39 05
 013 981 42 05
 013 981 43 05
 013 997 05 47
 013 997 59 47
 013 997 94 47
 014 997 99 47
 015 981 75 05
 015 997 01 47
 015 997 46 47
 015 997 56 47
 015 997 58 47

VKHB 2161
 VKHB 2151
 VKHB 2066
 VKHB 2060
 VKHB 2007
 VKHB 2320
 VKHB 2319
 VKHB 2002
 VKHB 2002
 VKHB 2059
 VKHB 2321
 VKHB 2070
 VKS 6154
 VKS 6176
 VKHB 2164
 VKHB 2060
 VKHB 2234
 VKHB 2155
 VKHB 2156
 VKHB 2016
 VKS 6157
 VKHB 2165
 VKHB 2137
 VKHB 2159
 VKHB 2159
 VKHB 2233
 VKHB 2280
 VKHB 2191
 VKHB 2329
 VKHB 2191
 VKHB 2203
 VKHB 2156
 VKS 6158
 VKS 6174
 VKHB 2002
 VKS 6173
 VKS 6172
 VKS 6178
 VKS 6178
 VKS 6173
 VKS 6172
 VKHB 2003
 VKHB 2003
 VKS 6159
 VKS 6178
 VKHB 2072
 VKHB 2326
 VKS 6174
 VKS 6288
 VKS 6175
 VKHB 2307
 VKHB 2280
 VKHB 2280
 VKS 6181
 VKS 6183
 VKS 6181
 VKS 6299
 VKHB 2003
 VKS 6299
 VKS 6299
 VKS 6299
 VKS 6194

016 997 56 47
 019 997 48 47
 020 997 05 47
 020 997 39 47
 021 997 89 47
 022 997 52 47
 022 997 53 47
 022 997 59 47
 116 330 00 51
 116 586 00 33
 124 981 03 05
 140 981 00 05
 319 981 00 05
 319 981 02 05
 319 981 04 05
 319 981 06 05
 327 981 03 05
 327 981 04 05
 327 981 22 05
 601 350 04 68
 601 350 15 10
 604 330 00 25
 611 330 07 25
 611 330 08 25
 631 981 00 05
 902 350 00 68
 902 350 14 10

MERITOR (ROR)

212 00321 A
 21220158
 5000545227
 99041035 B
 99041045 B
 99041057
 99041058
 99041067
 99041068
 99041075

OPEL

44 03 023
 44 03 044
 44 08 277
 44 08 668
 44 08 669
 45 01 154
 45 01 155
 9111023
 9111044
 91159917
 91160086
 91160087
 9161454
 9161455

VKS 6183
 VKS 6150
 VKS 6334
 VKS 6353
 VKS 6315
 VKS 6351
 VKS 6350
 VKS 6352
 VKBA 596
 VKBA 596
 VKHB 2055
 VKHB 2057
 VKHB 2018
 VKHB 2019
 VKHB 2017
 VKHB 2058
 VKHB 2033
 VKHB 2080
 VKHB 2080
 VKBA 1470
 VKBA 1470
 VKBA 3434
 VKBA 596
 VKBA 3434
 VKHB 2296
 VKBA 3435
 VKBA 3435

VKS 6205
 VKS 6260
 VKS 6239
 VKHB 2029
 VKHB 2051
 VKHB 2030
 VKHB 2297
 VKHB 2298
 VKHB 2299
 VKHB 2315

VKBA 3613
 VKBA 3614
 VKBA 3617
 VKBA 3618
 VKBA 3616
 VKBA 3500
 VKBA 3501
 VKBA 3613
 VKBA 3614
 VKBA 3617
 VKBA 3618
 VKBA 3616
 VKBA 3500
 VKBA 3616
 VKBA 3500
 VKBA 3501

PEUGEOT

3350.21
 3350.24
 3350.25
 3350.26
 3350.29
 3350.30
 3730.22
 95 555 853
 ZF05996248

VKBA 1444
 VKBA 3428
 VKBA 3429
 VKBA 3430
 VKBA 1444
 VKBA 3428
 VKHB 2016
 VKBA 813
 VKHB 2016

RENAULT / RVI

0023336006
 0023336033
 0023336034
 0023336042
 0023336044
 0023336046
 0023336074
 0023336078
 0023336081
 0023336108
 0023336123
 0023336124
 0023336246
 0023336864
 0023336874
 0024472286
 0024472569
 0024472667
 0024472709
 0024482709
 00546524
 00671980
 00785895
 0773230500
 0773230700
 0773230900
 0857596000
 50 00 788 712
 5000 675 159
 5000254793
 50003090069
 50003090902
 5000350020
 5000350029
 5000350189
 5000350270
 5000388284
 5000389250
 5000391585
 5000391891
 5000392236
 5000392237
 5000392404
 5000395649
 5000434273
 5000437791
 5000442185

VKHB 2042
 VKHB 2282
 VKHB 2154
 VKHB 2287
 VKHB 2160
 VKHB 2186
 VKHB 2187
 VKHB 2056
 VKHB 2173
 VKHB 2029
 VKHB 2186
 VKHB 2187
 VKHB 2169
 VKHB 2185
 VKHB 2243
 VKS 6202
 VKS 6175
 VKS 6201
 VKS 6234
 VKS 6234
 VKHB 2065
 VKS 6201
 VKHB 2192
 VKHB 2294
 VKHB 2063
 VKHB 2004
 VKHB 2236
 VKHB 2182
 VKS 6237
 VKHB 2170
 VKHB 2067
 VKHB 2190
 VKHB 2048
 VKHB 2046
 VKHB 2047
 VKHB 2045
 VKHB 2018
 VKHB 2060
 VKHB 2191
 VKS 6229
 VKHB 2191
 VKHB 2060
 VKS 6238
 VKS 6219
 VKHB 2067
 VKHB 2051
 VKHB 2068

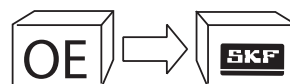
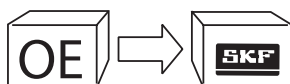
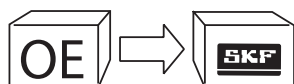

5000442186
5000470672
5000470673

5000470861
5000470862
5000545227
5000546524
5000546916

5000598486
5000669957
5000671980
5000673467
5000675250

5000675627
5000682662
5000682886
5000685691
5000685835

5000685836
5000685837
5000685838
5000685839
5000690018

5000785261
5000785895
5000785898
5000785909
5000785910

5000786298
5000787789
5000788063
5000788202
5000788490

5000788712
5000873122
5000877056
5001830654
5001835188

5001858475
5003087034
5003090060
5003090061
5003090068

5003090069
5003090900
5003090901
5003090902
5003090903

5010 308 616
5010 439 054
5010 439 055
5010 439 056
5010 439 057

5010 439 060
5010 439 061
5010 439 065
5010 439 171
5010 439 190

5010 439 224
5010 439 570
5010 439 571
5010 443 768

VKHB 2068
VKHB 2068
VKHB 2066

VKHB 2068
VKHB 2066
VKS 6239
VKHB 2065
VKS 6219

VKHB 2061
VKHB 2068
VKS 6201
VKHB 2182
VKHB 2158

VKHB 2194
VKHB 2161
VKHB 2226
VKHB 2199
VKHB 2045

VKHB 2047
VKHB 2044
VKHB 2046
VKHB 2048
VKHB 2182

VKS 6233
VKHB 2192
VKHB 2194
VKHB 2194
VKHB 2192

VKHB 2061
VKS 6234
VKHB 2017
VKHB 2017
VKS 6140

VKHB 2182
VKHB 2051
VKHB 2184
VKHB 2320
VKS 6205

VKS 6233
VKS 6303
VKHB 2184
VKHB 2184
VKHB 2179

VKHB 2067
VKHB 2067
VKHB 2179
VKHB 2190
VKHB 2057

VKBA 5407
VKHB 2179
VKHB 2182
VKHB 2065
VKHB 2068

VKHB 2067
VKHB 2061
VKHB 2051
VKHB 2046
VKHB 2047

VKHB 2161
VKHB 2158
VKHB 2192
VKHB 2338

5010 443 903
5010 566 199
5010 587 007
5010 587 008
5010 587 009
5010067534
5010136663
5010136758
5010136759
5010136762
5010136766
5010136767
5010136769
5010136770
5010216920
5010241096
5010251382
5010443187
5010443189
5516010033
5516010498
5516010506
5516010573
5516010574
5516010587
5516011446
5516014042
5516014319
5516015596
5516015599
5516015839
5516016788
77 01 205 416
77 01 205 417
77 01 205 692
77 01 206 740
77 01 206 742
77 01 206 847
77 01 206 848
77 01 206 849
77 01 207 358
77 01 207 966
77 01 208 427
77 01 461 730
77 01 462 021
77 01 463 940
77 01 465 646
77 01 465 647
77 01 468 409
7701003394
7703090029
7703090034
7703090085
7703090098
959232207

SAF

4 200 0011 00
4 200 1006 00
4.200,0014.00

VKHB 2169
VKS 6201
VKHB 2158
VKHB 2194
VKHB 2337
VKS 6175

VKHB 2066
VKHB 2057
VKHB 2190
VKHB 2065
VKHB 2179

VKHB 2067
VKHB 2051
VKHB 2184
VKBA 5308
VKHB 2161

VKHB 2294
VKS 6375
VKS 6234
VKHB 2045
VKHB 2046

VKHB 2016
VKHB 2018
VKHB 2019
VKHB 2067
VKHB 2047

VKHB 2020
VKHB 2048
VKS 6236
VKS 6237
VKHB 2044

VKHB 2044
VKBA 3500
VKBA 3501
VKBA 909
VKBA 3613

VKBA 3614
VKBA 3618
VKBA 3616
VKBA 3617
VKBA 3648

VKBA 3648
VKBA 3648
VKBA 830
VKBA 909
VKBA 977

VKBA 3407
VKBA 828
VKBA 829
VKS 6235
VKHB 2296

VKHB 2188
VKHB 2016
VKHB 2189
VKHB 2018

VKHB 2016
VKHB 2029
VKHB 2198

4.200. 0023.00
4.200.0011.00
4.200.0012.00
4.200.0015.00
4.200.0016.00
4.200.0023.00
4.200.0027.00
4.200.0028.00
4.200.0033.00
4.200.0034.00
4.200.0055.00
4.200.0057.00
4.200.0058.00
4.200.0060.00
4.200.0063.00
4.200.0064.00
4.200.1007.00
4.200.1010.00
4.373.0005.00
4.373.0010.00
4.373.0035.01

SCANIA
1301682
1301694
1309570
1342706
1362149
1364631
1409889
1409890
14102
14103
1413785
1439070
1443078
14623
14698
14764
1476945
14835
14836
1524625
1534012
1724482
173320
174717
177893
260998
284843
291060
291076
297991
322748
322749
33352
33948
345835
354076
362226

VKHB 2288
VKHB 2202

VKHB 2201
VKHB 2283
VKHB 2304
VKHB 2288
VKHB 2030

VKHB 2212
VKHB 2003
VKHB 2072
VKHB 2214
VKHB 2182

VKHB 2061
VKHB 2051
VKHB 2067
VKHB 2173
VKHB 2050

VKHB 2247
VKS 6292
VKS 6249
VKS 6205

VKHB 2157
VKHB 2326
VKHB 2048
VKHB 2305
VKHB 2004

VKHB 2321
VKS 6372
VKS 6105
VKHB 2033
VKHB 2026

VKBA 5314
VKBA 5314
VKBA 5314
VKHB 2004
VKHB 2001

VKHB 2002
VKBA 5314
VKHB 2030
VKHB 2003
VKHB 2029

VKS 6372
VKBA 5314
VKS 6108
VKHB 2334
VKHB 2033

VKHB 2028
VKHB 2065
VKHB 2029
VKS 6111
VKS 6109

VKHB 2024
VKHB 2006
VKS 6105
VKHB 2031
VKHB 2173

VKHB 2032
VKHB 2281

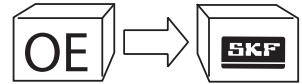
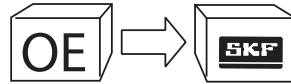
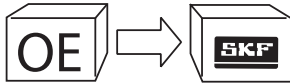

370074
370076
374330

375086
375087
383343
392039

VKS 6109
VKS 6111
VKHB 2255

VKS 6261
VKS 6284
VKHB 2147
VKHB 2228

183766
183767
183768
183769
183777

183778
183813 + 183812
183817
184068
184593

VKHB 2047
VKHB 2046
VKHB 2048
VKHB 2019
VKHB 2045

VKHB 2044
VKHB 2023
VKHB 2021
VKHB 2282
VKHB 2015

TRAILOR

43752
T6014000T000
T6015000D000
M003168
M200021-01

M200021-02
M200031-03

VKS 6295
VKKB 2226
VKHB 2205
VKHB 2279
VKS 6365

VKS 6366
VKS 6364

18459
184623
184625
184637
184672

184678
184794
20428192
3090331
6771541

VKHB 2334
VKHB 2169
VKHB 2306
VKHB 2143
VKHB 2051

VKHB 2222
VKHB 2043
VKHB 2036
VKS 6298
VKS 6139

VOLVO

1089552
11062
11073
11137
1194652

1522372
1587792
1593459
1594257
16107658

VKS 6134
VKHB 2070
VKHB 2007
VKHB 2015
VKHB 2004

VKS 6132
VKS 6134
VKS 6207
VKS 6136
VKS 6135

6771769
7011137
7169934
8151816
8151820

944667
947271
968013

VKS 6140
VKHB 2015
VKHB 2255
VKHB 2024
VKHB 2036

VKS 6114
VKS 6239
VKS 6202

1610765
1652119
1652127
1652563
1654320

VKS 6135
VKHB 2334
VKHB 2065
VKHB 2173
VKHB 2228

VW

211 498 071 BS
211 498 071
281 498 625
291 501 319 B
293 501 319

2D0 407 625
2D0 498 625
2D0 501 319 A
2D0 501 319 B
701 498 625

701 598 625 A
701 598 625
7D0 498 625
7L0 498 611

VKBA 519
VKBA 519
VKBA 802
VKHB 2017
VKHB 2060

VKHB 2057
VKBA 3434
VKHB 2017
VKHB 2060
VKBA 3406

VKBA 3406
VKBA 3406
VKBA 3406
VKBA 3646

1654326
1667065
1672249
1698580
1699339

VKHB 2066
VKS 6142
VKS 6132
VKHB 2029
VKHB 2225

1699340
181086
181133
181278
181298 + 181128

VKHB 2003
VKHB 2031
VKHB 2309
VKHB 2042
VKHB 2040

181299 + 181125
181338 + 181402
181596 + 181279
181669
183245

VKHB 2041
VKHB 2014
VKHB 2143
VKHB 2001
VKHB 2175

183326
183348
183351
183356
183583

VKHB 2053
VKHB 2050
VKHB 2029
VKHB 2309
VKHB 2016

183648
183667
183684
183763
183765

VKHB 2182
VKHB 2046
VKHB 2018
VKHB 2020
VKHB 2017

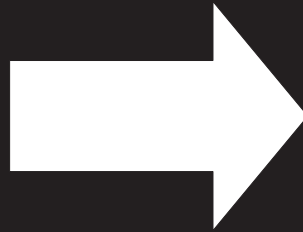

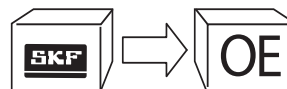
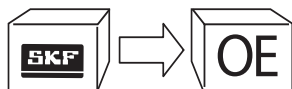

VKBA 519	VW	211 498 071			RENAULT / RVI	77 01 206 742
	VW	211 498 071 BS		VKBA 3616	OPEL	44 08 669
VKBA 523	FORD	5 007 029			OPEL	91160087
VKBA 528	FORD	5 007 028			RENAULT / RVI	77 01 206 848
VKBA 596	MERCEDES BENZ	116 330 00 51		VKBA 3617	OPEL	44 08 277
	MERCEDES BENZ	116 586 00 33			OPEL	91159917
	MERCEDES BENZ	611 330 07 25			RENAULT / RVI	77 01 206 849
VKBA 741	FORD	5 010 762		VKBA 3618	OPEL	44 08 668
VKBA 802	VW	281 498 625			OPEL	91160086
VKBA 813	CITROËN	95 555 853			RENAULT / RVI	77 01 206 847
	PEUGEOT	95 555 853		VKBA 3646	VW	7L0 498 611
VKBA 828	RENAULT / RVI	77 01 465 647		VKBA 3648	RENAULT / RVI	77 01 207 358
VKBA 829	RENAULT / RVI	77 01 468 409			RENAULT / RVI	77 01 207 966
VKBA 830	RENAULT / RVI	77 01 461 730			RENAULT / RVI	77 01 208 427
VKBA 909	RENAULT / RVI	77 01 205 692		VKBA 3654	FORD	1 318 151
	RENAULT / RVI	77 01 462 021		VKBA 3655	FORD	1 318 154
VKBA 922	FORD	5 007 036		VKBA 5308	RENAULT / RVI	5010216920
VKBA 923	FORD	5 007 041		VKBA 5314	SCANIA	1413785
VKBA 957	FORD	5 015 586			SCANIA	1439070
VKBA 958	FORD	5 015 587			SCANIA	1443078
VKBA 959	FORD	5 015 650			SCANIA	1476945
VKBA 977	RENAULT / RVI	77 01 463 940			SCANIA	1724482
VKBA 1444	CITROËN	3350.21		VKBA 5377	MAN	81.93420.0288
	CITROËN	3350.29		VKBA 5397	FIAT / IVECO	718 3075
	PEUGEOT	3350.21		VKBA 5407	RENAULT / RVI	5010 308 616
	PEUGEOT	3350.29		VKBA 5408	MAN	81.93420.0342
VKBA 1465	FORD	1 053 115		VKBA 5409	FIAT / IVECO	7183074
	FORD	5 025 899		VKBA 5521	BPW	09.801.02.33.0
VKBA 1466	FORD	5 025 900			BPW	09.801.02.72.0
VKBA 1467	FORD	5 025 901		VKBA 5522	BPW	09.801.02.34.0
VKBA 1470	MERCEDES BENZ	601 350 04 68		VKBA 5524	BPW	09.801.02.98.0
	MERCEDES BENZ	601 350 15 10		VKBA 5525	BPW	09.801.02.19.0
VKBA 3406	VW	701 498 625		VKBA 5526	BPW	09.801.02.20.0
	VW	701 598 625		VKBA 5527	BPW	09.801.02.24.0
	VW	701 598 625 A		VKBA 5550	BPW	09.801.06.26.0
	VW	7D0 498 625		VKBA 5551	BPW	09.801.06.27.0
VKBA 3407	RENAULT / RVI	77 01 465 646		VKHB 2001	FIAT / IVECO	1126887
VKBA 3428	CITROËN	3350.24			FIAT / IVECO	26800580
	CITROËN	3350.30			SCANIA	14698
	PEUGEOT	3350.24			VOLVO	181669
	PEUGEOT	3350.30		VKHB 2002	DAF	0275823
VKBA 3429	CITROËN	3350.25			FIAT / IVECO	26800610
	FIAT / IVECO	71714454			MERCEDES BENZ	006 981 08 05
	PEUGEOT	3350.25			MERCEDES BENZ	006 981 69 05
VKBA 3430	CITROËN	3350.26			MERCEDES BENZ	006 981 74 05
	FIAT / IVECO	71714452			MERCEDES BENZ	010 981 93 05
	PEUGEOT	3350.26			SCANIA	14764
VKBA 3434	MERCEDES BENZ	604 330 00 25		VKHB 2003	FIAT / IVECO	26800390
	MERCEDES BENZ	611 330 08 25			MERCEDES BENZ	011 981 68 05
	VW	2D0 498 625			MERCEDES BENZ	011 981 69 05
VKBA 3435	MERCEDES BENZ	902 350 00 68			MERCEDES BENZ	015 981 75 05
	MERCEDES BENZ	902 350 14 10			SAF	4.200.0033.00
VKBA 3500	OPEL	45 01 154			SCANIA	14836
	OPEL	9161454			VOLVO	1699340
	RENAULT / RVI	77 01 205 416		VKHB 2004	BPW	02.6406.45.00
VKBA 3501	OPEL	45 01 155			DAF	0140896
	OPEL	9161455			DAF	283686
	RENAULT / RVI	77 01 205 417			FIAT / IVECO	1110018
VKBA 3551	FIAT / IVECO	99825736			FIAT / IVECO	1110019
VKBA 3553	FIAT / IVECO	9381 0034			KÄSSBOHRER	6.691.168.000
VKBA 3588	FORD	1 201 300			MAN	06.32499.0013
VKBA 3589	FORD	1 201 304			RENAULT / RVI	0773230900
VKBA 3590	FORD	1 201 303			SCANIA	1362149
VKBA 3613	OPEL	44 03 023			SCANIA	14623
	OPEL	9111023			VOLVO	1194652
	RENAULT / RVI	77 01 206 740		VKHB 2006	SCANIA	322749
VKBA 3614	OPEL	44 03 044		VKHB 2007	MERCEDES BENZ	000 981 95 05
	OPEL	9111044			MERCEDES BENZ	000720 032306

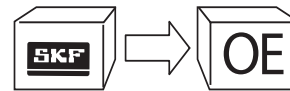
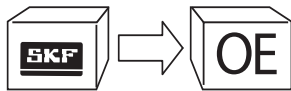

VKHB 2013	MERCEDES BENZ	001 981 87 05	VKHB 2028	MERCEDES BENZ	000 981 24 01
	MERCEDES BENZ	001 981 95 05		MERCEDES BENZ	000 981 72 05
	MERCEDES BENZ	006 981 59 05		MERCEDES BENZ	000 981 94 05
VKHB 2014	VOLVO	11073	VKHB 2029	MERCEDES BENZ	000720 032216
	FIAT / IVECO	4540025		MERCEDES BENZ	006 981 06 05
VKHB 2015	VOLVO	181338 + 181402	VKHB 2030	SCANIA	14103
	VOLVO	11137		BPW	02.6407.75.00
VKHB 2016	VOLVO	184593	VKHB 2031	BPW	02.6410.29.00
	VOLVO	7011137		MERCEDES BENZ	001 980 27 02
VKHB 2017	CITROËN	3730.22	VKHB 2032	MERCEDES BENZ	002 981 86 05
	CITROËN	ZF05996248		VKHB 2033	MERCEDES BENZ
VKHB 2018	DAF	491899	VKHB 2034		SCANIA
	FIAT / IVECO	5996248		VKHB 2035	SCANIA
VKHB 2019	MAN	06.34299.0066	VKHB 2040		BPW
	MERCEDES BENZ	000720 032206		VKHB 2041	MERITOR (ROR)
VKHB 2020	MERCEDES BENZ	001 981 15 05	VKHB 2042		RENAULT / RVI
	MERCEDES BENZ	001 981 61 05		VKHB 2043	SAF
VKHB 2021	MERCEDES BENZ	001 981 65 05	VKHB 2044		SCANIA
	MERCEDES BENZ	007 981 76 05		VKHB 2045	SCANIA
VKHB 2022	MERCEDES BENZ	3730.22	VKHB 2046		VOLVO
	PEUGEOT	ZF05996248		VKHB 2046	VOLVO
VKHB 2023	PEUGEOT	5516010506	VKHB 2046		FIAT / IVECO
	RENAULT / RVI	7703090085		VKHB 2046	KÄSSBOHRER
VKHB 2024	RENAULT / RVI	7703090085	VKHB 2046		MERITOR (ROR)
	SAF	4 200 0011 00		VKHB 2046	RENAULT / RVI
VKHB 2025	VOLVO	183583	VKHB 2046		SAF
	VOLVO	26800160		VKHB 2046	SCANIA
VKHB 2026	MERCEDES BENZ	000 981 36 05	VKHB 2046		SCANIA
	MERCEDES BENZ	000720 032210		VKHB 2046	BPW
VKHB 2027	MERCEDES BENZ	000720 432210	VKHB 2046		BPW
	MERCEDES BENZ	001 981 89 05		VKHB 2046	FIAT / IVECO
VKHB 2028	MERCEDES BENZ	002 981 19 05	VKHB 2046		FIAT / IVECO
	MERCEDES BENZ	002 981 22 05		VKHB 2046	SCANIA
VKHB 2029	MERCEDES BENZ	005 981 53 05	VKHB 2046		VOLVO
	MERCEDES BENZ	319 981 04 05		VKHB 2046	SCANIA
VKHB 2030	MERCEDES BENZ	5000788063	VKHB 2046		FIAT / IVECO
	MERCEDES BENZ	5000788202		VKHB 2046	MAN
VKHB 2031	RENAULT / RVI	183765	VKHB 2046		MERCEDES BENZ
	RENAULT / RVI	291 501 319 B		VKHB 2046	MERCEDES BENZ
VKHB 2032	VW	200 501 319 A	VKHB 2046		MERCEDES BENZ
	VW	06.32499.0079		VKHB 2046	SCANIA
VKHB 2033	MAN	319 981 00 05	VKHB 2046		SCANIA
	MERCEDES BENZ	5000388284		VKHB 2046	SCANIA
VKHB 2034	RENAULT / RVI	5516010573	VKHB 2046		DAF
	RENAULT / RVI	959232207		VKHB 2046	DAF
VKHB 2035	VOLVO	183684	VKHB 2046		VOLVO
	FIAT / IVECO	1125929		VKHB 2046	VOLVO
VKHB 2036	FIAT / IVECO	26800170	VKHB 2046		FORD
	MAN	87.52330.0600		VKHB 2046	MERCEDES BENZ
VKHB 2037	MERCEDES BENZ	000 981 33 05	VKHB 2046		MERCEDES BENZ
	MERCEDES BENZ	000 981 90 05		VKHB 2046	MERCEDES BENZ
VKHB 2038	MERCEDES BENZ	000720 032211	VKHB 2046		MERCEDES BENZ
	MERCEDES BENZ	001 981 84 05		VKHB 2046	MERCEDES BENZ
VKHB 2039	MERCEDES BENZ	001 981 86 05	VKHB 2046		VOLVO
	MERCEDES BENZ	002 981 24 05		VKHB 2046	DAF
VKHB 2040	MERCEDES BENZ	319 981 02 05	VKHB 2046		RENAULT / RVI
	RENAULT / RVI	5516010574		VKHB 2046	VOLVO
VKHB 2041	VOLVO	183769	VKHB 2046		DAF
	FIAT / IVECO	1110002		VKHB 2046	DAF
VKHB 2042	FIAT / IVECO	26800140	VKHB 2046		VOLVO
	MAN	06.32499.0063		VKHB 2046	MAN
VKHB 2043	RENAULT / RVI	5516014042	VKHB 2046		MERCEDES BENZ
	VOLVO	183763		VKHB 2046	RENAULT / RVI
VKHB 2044	VOLVO	183817	VKHB 2046		RENAULT / RVI
	VOLVO	183813 + 183812		VKHB 2046	RENAULT / RVI
VKHB 2045	SCANIA	322748	VKHB 2046		VOLVO
	VOLVO	8151816		VKHB 2046	VOLVO
VKHB 2046	KÄSSBOHRER	6.691.159.000	VKHB 2046		RENAULT / RVI
	MERCEDES BENZ	000 981 03 05		VKHB 2046	RENAULT / RVI
			VKHB 2046		VOLVO
				VKHB 2046	FIAT / IVECO



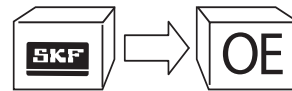
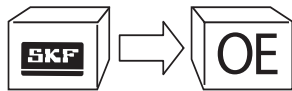

VKHB 2047	MAN	06.32499.0058	VKHB 2061	FIAT / IVECO	7165686
	RENAULT / RVI	5000350029		FIAT / IVECO	42492259
	RENAULT / RVI	5000685838		MERCEDES BENZ	004 981 64 05
	RENAULT / RVI	5010 439 171		MERCEDES BENZ	004 981 65 05
	RENAULT / RVI	5516010498		MERCEDES BENZ	004 981 67 05
	VOLVO	183667		RENAULT / RVI	5000598486
	VOLVO	183767		RENAULT / RVI	5000786298
	RENAULT / RVI	5000350189		RENAULT / RVI	5010 439 061
	RENAULT / RVI	5000685836		SAF	4.200.0058.00
	RENAULT / RVI	5516011446		FIAT / IVECO	1110016
VKHB 2048	RENAULT / RVI	5010 439 190	VKHB 2063	MERCEDES BENZ	000 981 96 05
	VOLVO	183766		MERCEDES BENZ	000720 032307
	RENAULT / RVI	5000350020		MERCEDES BENZ	001 981 56 05
VKHB 2050	RENAULT / RVI	5000685839	VKHB 2064	MERCEDES BENZ	001 981 70 05
	RENAULT / RVI	5516014319		MERCEDES BENZ	003 981 64 05
	SCANIA	1309570		MERCEDES BENZ	006 981 07 05
VKHB 2051	VOLVO	183768	VKHB 2065	RENAULT / RVI	0773230700
	SAF	4.200.1007.00		MERCEDES BENZ	004 981 34 05
VKHB 2053	VOLVO	183348	VKHB 2066	MERCEDES BENZ	004 981 38 05
	BPW	02.6407.65.00		BPW	02.6407.40.00
	FIAT / IVECO	7174946		FIAT / IVECO	1905261
	MERCEDES BENZ	001 980 09 02		FIAT / IVECO	8582739
	MERCEDES BENZ	003 981 37 05		MAN	06.32489.0002
	MERCEDES BENZ	003 981 74 05		MAN	81.93420.0077
	RENAULT / RVI	5000437791		MERCEDES BENZ	003 981 39 05
	RENAULT / RVI	5000873122		MERCEDES BENZ	003 981 72 05
	RENAULT / RVI	5010 439 065		MERCEDES BENZ	004 981 68 05
	RENAULT / RVI	5010136769		RENAULT / RVI	00546524
VKHB 2054	MERITOR (ROR)	99041045 B	RENAULT / RVI	5000546524	
	SAF	4.200.0060.00	RENAULT / RVI	5010136762	
	VOLVO	184672	RENAULT / RVI	5010 439 056	
VKHB 2055	VOLVO	183326	VKHB 2067	SCANIA	284843
	FIAT / IVECO	4023140		VOLVO	1652127
VKHB 2056	MERCEDES BENZ	002 981 28 05	VKHB 2068	MERCEDES BENZ	003 981 52 05
	MERCEDES BENZ	000 980 50 02		MERCEDES BENZ	003 981 56 05
	MERCEDES BENZ	000 980 54 02		MERCEDES BENZ	003 981 85 05
VKHB 2057	MERCEDES BENZ	000 980 55 02	VKHB 2069	MERCEDES BENZ	006 981 52 05
	MERCEDES BENZ	124 981 03 05		RENAULT / RVI	5000470673
	MERCEDES BENZ	003 981 11 05		RENAULT / RVI	5000470862
VKHB 2058	MERCEDES BENZ	003 981 16 05	VKHB 2070	RENAULT / RVI	5010136663
	MERCEDES BENZ	003 981 96 05		VOLVO	1654326
	RENAULT / RVI	0023336078		BPW	02.6407.45.01
VKHB 2059	MERCEDES BENZ	003 981 10 05	VKHB 2071	DAF	636820
	MERCEDES BENZ	003 981 15 05		MAN	06.32489.0044
	MERCEDES BENZ	003 981 95 05		MERCEDES BENZ	003 981 53 05
VKHB 2060	MERCEDES BENZ	140 981 00 05	VKHB 2072	MERCEDES BENZ	003 981 57 05
	RENAULT / RVI	5003090903		MERCEDES BENZ	005 981 41 05
	RENAULT / RVI	5010136758		RENAULT / RVI	50003090069
VKHB 2061	VW	2D0 407 625	VKHB 2073	RENAULT / RVI	5000434273
	MERCEDES BENZ	000720 032304		RENAULT / RVI	5003090900
	MERCEDES BENZ	001 981 90 05		RENAULT / RVI	5010136767
VKHB 2062	MERCEDES BENZ	002 981 20 05	VKHB 2074	RENAULT / RVI	5516010587
	MERCEDES BENZ	319 981 06 05		RENAULT / RVI	5010 439 060
	FIAT / IVECO	7160360		SAF	4.200.0063.00
VKHB 2063	MERCEDES BENZ	000 980 75 02	VKHB 2075	DAF	614943
	MERCEDES BENZ	000 981 83 02		MAN	81.93420.0072
	MERCEDES BENZ	006 981 82 05		MERCEDES BENZ	002 981 79 05
VKHB 2064	FIAT / IVECO	1101597	VKHB 2076	MERCEDES BENZ	003 981 83 05
	FIAT / IVECO	7162191		MERCEDES BENZ	004 981 42 05
	MERCEDES BENZ	000 981 90 02		RENAULT / RVI	5000442185
VKHB 2065	MERCEDES BENZ	002 981 13 05	VKHB 2077	RENAULT / RVI	5000442186
	MERCEDES BENZ	002 981 66 05		RENAULT / RVI	5000470672
	MERCEDES BENZ	006 981 56 05		RENAULT / RVI	5000470861
VKHB 2066	MERCEDES BENZ	007 981 04 05	VKHB 2078	RENAULT / RVI	5000669957
	RENAULT / RVI	5000389250		RENAULT / RVI	5010 439 057
	RENAULT / RVI	5000392237		DAF	0556289
VKHB 2067	VW	293 501 319	VKHB 2079	DAF	626875
	VW	2D0 501 319 B		FIAT / IVECO	1110020

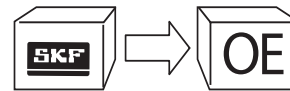
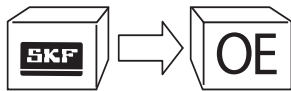

	FIAT / IVECO	26800600		VOLVO	181596 + 181279
	MAN	06.32499.0016		VOLVO	184637
	MERCEDES BENZ	000720 032310	VKHB 2145	DAF	676988
	MERCEDES BENZ	001 981 29 05	VKHB 2146	DAF	0266488
	MERCEDES BENZ	001 981 74 05		DAF	266488
	MERCEDES BENZ	001 981 82 02		MAN	06.32499.0126
	MERCEDES BENZ	006 981 99 05		MAN	06.32499.0127
	VOLVO	11062		MAN	06.32499.0188
VKHB 2071	KÄSSBOHRER	6.691.383.000	VKHB 2147	DAF	0266487
	KÄSSBOHRER	6.691.383.000E		DAF	266487
	MERCEDES BENZ	005 981 31 05		SCANIA	383343
VKHB 2072	BPW	02.6406.70.00	VKHB 2151	FIAT / IVECO	4096587
	BPW	02.6410.27.00		MERCEDES BENZ	001 980 29 02
	FIAT / IVECO	26800640		MERCEDES BENZ	006 981 51 05
	MERCEDES BENZ	004 981 98 05	VKHB 2153	MERCEDES BENZ	001 980 62 02
	MERCEDES BENZ	004 981 99 05	VKHB 2154	FIAT / IVECO	1905216
	MERCEDES BENZ	005 981 00 05		FIAT / IVECO	7164410
	MERCEDES BENZ	012 981 32 05		MERCEDES BENZ	005 981 66 05
	SAF	4.200.0034.00		MERCEDES BENZ	005 981 95 05
VKHB 2075	MAN	81.93420.6001		MERCEDES BENZ	005 981 98 05
	MERCEDES BENZ	001 981 05 05	VKHB 2155	RENAULT / RVI	0023336034
	MERCEDES BENZ	001 981 38 05		MERCEDES BENZ	002 981 95 05
	MERCEDES BENZ	002 981 05 05		MERCEDES BENZ	003 981 00 05
VKHB 2076	MERCEDES BENZ	000 980 72 02	VKHB 2156	MERCEDES BENZ	007 981 25 05
	MERCEDES BENZ	000 980 74 02		MERCEDES BENZ	003 981 43 05
	MERCEDES BENZ	002 981 92 02		MERCEDES BENZ	005 981 44 05
VKHB 2079	MERCEDES BENZ	000 981 41 05		MERCEDES BENZ	007 981 57 05
	MERCEDES BENZ	000 981 92 05		MERCEDES BENZ	009 981 93 05
VKHB 2080	FIAT / IVECO	7164544	VKHB 2157	MERCEDES BENZ	00640618
	FIAT / IVECO	26800230		DAF	000720 032016
	MERCEDES BENZ	000 981 22 05		SCANIA	1301682
	MERCEDES BENZ	000720 032217	VKHB 2158	MERCEDES BENZ	001 980 67 02
	MERCEDES BENZ	002 981 17 05		MERCEDES BENZ	005 981 83 05
	MERCEDES BENZ	002 981 18 05		MERCEDES BENZ	005 981 86 05
	MERCEDES BENZ	327 981 04 05		MERCEDES BENZ	005 981 99 05
	MERCEDES BENZ	327 981 22 05		RENAULT / RVI	5000675250
VKHB 2081	MERCEDES BENZ	002 981 55 05		RENAULT / RVI	5010 439 570
	MERCEDES BENZ	002 981 56 05		RENAULT / RVI	5010 587 007
VKHB 2082	DAF	676987	VKHB 2159	MERCEDES BENZ	008 981 83 05
	FIAT / IVECO	1104923		MERCEDES BENZ	008 981 84 05
	MAN	06.32499.0036	VKHB 2160	FIAT / IVECO	1104922
	MERCEDES BENZ	000 980 96 02		FIAT / IVECO	8190538
	MERCEDES BENZ	002 981 90 05		KÄSSBOHRER	6.691.453.000
	MERCEDES BENZ	003 981 86 05		MAN	06.32489.0071
VKHB 2083	MERCEDES BENZ	000 981 75 05		MERCEDES BENZ	003 981 25 05
	MERCEDES BENZ	000 981 79 05		MERCEDES BENZ	003 981 27 05
	MERCEDES BENZ	001 981 45 05		RENAULT / RVI	0023336044
VKHB 2088	FORD	A 790X 1200 BA	VKHB 2161	DAF	AMPA012
VKHB 2089	DAF	202825		MAN	06.32489.0012
VKHB 2124	FIAT / IVECO	1905027		MAN	06.32489.0114
	MERCEDES BENZ	001 980 66 02		MERCEDES BENZ	000720 032019
	MERCEDES BENZ	005 981 84 05		MERCEDES BENZ	001 980 26 02
	MERCEDES BENZ	005 981 85 05		MERCEDES BENZ	002 981 54 05
	MERCEDES BENZ	006 981 01 05		MERCEDES BENZ	003 981 51 05
VKHB 2132	DAF	260204		MERCEDES BENZ	006 981 47 05
	MAN	06.32499.0043		RENAULT / RVI	5000682662
	MAN	06.32499.0081		RENAULT / RVI	5010241096
VKHB 2137	DAF	10901093		RENAULT / RVI	5010 439 224
	DAF	254912	VKHB 2162	FIAT / IVECO	41800341
	FIAT / IVECO	7166346		MAN	06.32499.0096
	MAN	06.32499.0103		MERCEDES BENZ	000 980 97 02
	MERCEDES BENZ	008 981 53 05		MERCEDES BENZ	003 981 26 05
VKHB 2140	DAF	631780		MERCEDES BENZ	003 981 28 05
VKHB 2141	DAF	0174595	VKHB 2163	MERCEDES BENZ	005 981 49 05
	DAF	174595		MAN	06.32499.0044
VKHB 2142	DAF	325333		MAN	06.32499.0155
	FORD	A790X 1242 FA		MERCEDES BENZ	004 981 07 05
VKHB 2143	DAF	260724		MERCEDES BENZ	004 981 09 05



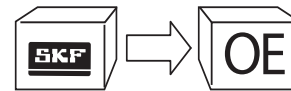
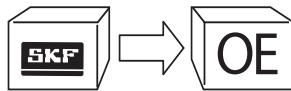

VKHB 2164	MERCEDES BENZ	005 981 21 05	VKHB 2191	RENAULT / RVI	5003090902
	MAN	06.32489.0032		RENAULT / RVI	5010136759
VKHB 2165	MERCEDES BENZ	004 981 21 05	MERCEDES BENZ	002 981 12 05	
	MERCEDES BENZ	004 981 49 05	MERCEDES BENZ	006 981 45 05	
	MERCEDES BENZ	007 981 00 05	MERCEDES BENZ	009 981 41 05	
VKHB 2168	MAN	06.32499.0046	MERCEDES BENZ	009 981 60 05	
	MAN	06.32499.0097	RENAULT / RVI	5000391585	
	MERCEDES BENZ	003 981 45 05	RENAULT / RVI	5000392236	
	MERCEDES BENZ	004 981 10 05	RENAULT / RVI	00785895	
VKHB 2169	MERCEDES BENZ	008 981 34 05	RENAULT / RVI	5000785895	
	FIAT / IVECO	1102857	RENAULT / RVI	5000785910	
VKHB 2170	MAN	06.32489.0019	RENAULT / RVI	5010 439 571	
	FIAT / IVECO	60115335	RENAULT / RVI	5000675627	
	MAN	06.32480.1200	RENAULT / RVI	5000785898	
VKHB 2172	MAN	06.32489.0060	RENAULT / RVI	5000785909	
	RENAULT / RVI	0023336246	RENAULT / RVI	5010 587 008	
	RENAULT / RVI	5010 443 903	FIAT / IVECO	26800620	
	VOLVO	184623	SAF	4.200.0014.00	
VKHB 2173	FIAT / IVECO	7162944	FIAT / IVECO	7164487	
	MAN	06.32489.0051	FIAT / IVECO	60141947	
	MERCEDES BENZ	004 981 17 05	RENAULT / RVI	5000685691	
VKHB 2174	RENAULT / RVI	5000254793	FIAT / IVECO	1384728	
	MAN	06.32489.0009	MERCEDES BENZ	002 981 16 05	
VKHB 2175	FIAT / IVECO	7160361	FIAT / IVECO	1109981	
	MAN	06.32489.0045	MERCEDES BENZ	006 981 42 05	
VKHB 2177	MAN	06.56289.0045	SAF	4.200.0012.00	
	RENAULT / RVI	0023336081	FIAT / IVECO	26800350	
	SAF	4.200.0064.00	SAF	4.200.0011.00	
VKHB 2178	SCANIA	345835	FIAT / IVECO	4711928	
	VOLVO	1652563	MERCEDES BENZ	009 981 81 05	
VKHB 2179	MAN	81.93420.0162	FIAT / IVECO	1126121	
	MAN	81.93420.0163	FIAT / IVECO	26800040	
VKHB 2180	VOLVO	183245	KÄSSBOHRER	6.691.128.000	
	BPW	02.6408.80.00	FRUEHAUF	T6015000D000	
VKHB 2181	BPW	02.6410.24.00	FIAT / IVECO	7160953	
	BPW	02.6408.90.00	TRAILOR> <T6015000D000		
VKHB 2182	BPW	02.6408.92.00	FIAT / IVECO	7164705	
	BPW	02.6410.23.00	FIAT / IVECO	1905220	
	FIAT / IVECO	7074945	FIAT / IVECO	7164543	
VKHB 2183	FIAT / IVECO	7174945	FIAT / IVECO	1905172	
	FIAT / IVECO	8582740	FIAT / IVECO	26800270	
VKHB 2184	MAN	06.32499.0175	FIAT / IVECO	7177004	
	RENAULT / RVI	5003090901	SAF	4.200.0028.00	
	RENAULT / RVI	5003090068	FIAT / IVECO	4690299	
VKHB 2185	RENAULT / RVI	5010 439 054	MAN	06.32499.0108	
	RENAULT / RVI	5010136766	MERCEDES BENZ	003 981 41 05	
VKHB 2186	FIAT / IVECO	7169935	SAF	4.200.0055.00	
	RENAULT / RVI	5000673467	FIAT / IVECO	1102864	
VKHB 2187	RENAULT / RVI	5000690018	FIAT / IVECO	1102860	
	RENAULT / RVI	5000788712	FIAT / IVECO	1103360	
VKHB 2188	RENAULT / RVI	5010 439 055	MAN	06.32489.0063	
	SAF	4.200.0057.00	BPW	02.6407.65.00	
VKHB 2189	VOLVO	183648	BPW	02.6407.67.00	
	RENAULT / RVI	5000877056	BPW	02.6410.22.00	
VKHB 2190	RENAULT / RVI	5003090060	DAF	325333	
	RENAULT / RVI	5003090061	FORD	A790X 1242 FA	
VKHB 2191	RENAULT / RVI	5010136770	DAF	0221664	
	RENAULT / RVI	0023336864	MAN	06.32499.0040	
VKHB 2192	FIAT / IVECO	8194959	MAN	06.32499.0131	
	RENAULT / RVI	0023336046	MERCEDES BENZ	003 981 32 05	
VKHB 2193	RENAULT / RVI	0023336123	VOLVO	184678	
	RENAULT / RVI	0023336074	BPW	02.6407.85.00	
VKHB 2194	RENAULT / RVI	0023336124	FIAT / IVECO	41800342	
	RENAULT / RVI	7703090034	VOLVO	1699339	
VKHB 2195	BPW	02.6401.25.00	FRUEHAUF	T6014000T000	
	RENAULT / RVI	7703090098	RENAULT / RVI	5000682886	
VKHB 2196	FIAT / IVECO	1905252	TRAILOR> <T6014000T000		
	RENAULT / RVI	50003090902	FRUEHAUF	A.JA 0813.001	

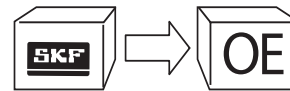
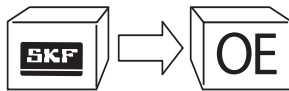

VKHB 2228	SCANIA VOLVO	392039 1654320	VKHB 2294	FIAT / IVECO RENAULT / RVI	93803935 0773230500
VKHB 2231	DAF	1327603	VKHB 2296	RENAULT / RVI MERCEDES BENZ	5010251382 631 981 00 05
VKHB 2232	DAF	0556290	VKHB 2297	RENAULT / RVI FIAT / IVECO	7703090029 1905351
VKHB 2233	MERCEDES BENZ	008 981 95 05	VKHB 2298	MERITOR (ROR) BPW	99041058 02.6408.80.00
VKHB 2234	MERCEDES BENZ	007 981 14 05	VKHB 2299	FIAT / IVECO FIAT / IVECO	99041067 9985454
VKHB 2236	DAF RENAULT / RVI	0283684 0857596000	VKHB 2300	MERITOR (ROR) DAF	99041067 0692180
VKHB 2237	BMW DAF	31 21 1 106 033 RTC 3427	VKHB 2301	FIAT / IVECO MAN	7982089 81.93420.0131
VKHB 2238	DAF DAF	4805 UKC 4805	VKHB 2302	MERITOR (ROR) BPW	99041068 02.6406.50.00
VKHB 2239	DAF DAF	494535 RTC 3412	VKHB 2303	BPW BPW	02.6410.25.00 02.6402.65.00
VKHB 2240	FIAT / IVECO MAN	9980735 06.32489.0072	VKHB 2304	SAF SAF	4.200.0016.00 1342706
VKHB 2241	DAF	495520	VKHB 2305	SCANIA DAF	0699117 001 981 64 05
VKHB 2242	DAF	491966	VKHB 2306	MERCEDES BENZ VOLVO	184625 013 981 39 05
VKHB 2243	DAF FIAT / IVECO MAN	13H6552 8194950 81935010028	VKHB 2307	MERCEDES BENZ FORD	A710X 1200 KA 181133
VKHB 2246	RENAULT / RVI DAF DAF	0023336874 494536 RTC 3436	VKHB 2309	FORD VOLVO VOLVO	183356 A710 1215 CA A790X 1242 DA
VKHB 2247	FIAT / IVECO FORD	9980734 0634048	VKHB 2310	FORD	99041075
VKHB 2248	FORD SAF	634 048 634048 4.200.1010.00	VKHB 2311	FORD	001 981 83 05
VKHB 2249	FIAT / IVECO KÄSSBOHRER	1102858 6.691.130.000	VKHB 2315	MERITOR (ROR)	002 981 82 05
VKHB 2250	MAN	06.32489.0021	VKHB 2317	MERCEDES BENZ	006 981 63 05
VKHB 2252	FIAT / IVECO	1905222	VKHB 2318	MERCEDES BENZ	81.93420.0285
VKHB 2253	FIAT / IVECO	1905221	VKHB 2319	MERCEDES BENZ	006 981 62 05
VKHB 2255	FIAT / IVECO SCANIA VOLVO	7172951 1905219 7169934 374330 7169934	VKHB 2320	MAN MERCEDES BENZ	5001830654 006 981 97 05
VKHB 2258	FIAT / IVECO	9980740	VKHB 2321	MERCEDES BENZ SCANIA	1364631 004 981 20 05
VKHB 2262	FIAT / IVECO FIAT / IVECO	26800330 93803934	VKHB 2323	MERCEDES BENZ MERCEDES BENZ	012 981 40 05 1301694
VKHB 2266	FIAT / IVECO	93806250	VKHB 2326	SCANIA	000 981 46 05
VKHB 2267	FIAT / IVECO	4330648	VKHB 2328	MERCEDES BENZ	009 981 43 05
VKHB 2268	FIAT / IVECO	4470124	VKHB 2329	MERCEDES BENZ	7174945
VKHB 2275	FIAT / IVECO	5996253	VKHB 2331	FIAT / IVECO	10901094
VKHB 2276	FIAT / IVECO	4330647	VKHB 2332	DAF	10271961
VKHB 2279	FRUEHAUF TRAILOR> <M003168	9980739 M 003168	VKHB 2333	DAF	1109968
VKHB 2280	MERCEDES BENZ MERCEDES BENZ	009 981 08 05 013 981 42 05	VKHB 2334	FIAT / IVECO SCANIA	174717 1652119
VKHB 2281	MERCEDES BENZ KÄSSBOHRER	013 981 43 05 6.691.450.000	VKHB 2337	VOLVO VOLVO	18459 5010 587 009
VKHB 2282	SCANIA FIAT / IVECO	362226 1102042	VKHB 2338	RENAULT / RVI RENAULT / RVI	5010 443 768 1905236
VKHB 2283	MAN RENAULT / RVI	06.32480.1000 0023336033	VKHB 2339	FIAT / IVECO	38510549
VKHB 2284	VOLVO	184068	VKS 6105	FIAT / IVECO SCANIA	1409890 33352
VKHB 2285	FIAT / IVECO	1102859	VKS 6108	SCANIA	173320
VKHB 2286	SAF	4.200.0015.00	VKS 6109	SCANIA	297991
VKHB 2287	FIAT / IVECO	1103142	VKS 6111	SCANIA	370074
VKHB 2288	FIAT / IVECO	1905300	VKS 6114	SCANIA	291076
VKHB 2289	FIAT / IVECO	42101665	VKS 6132	SCANIA	370076
VKHB 2290	RENAULT / RVI	0023336042	VKS 6134	VOLVO	944667
VKHB 2291	SAF	4.200.0023.00	VKS 6135	VOLVO	1522372
VKHB 2292	SAF	4.200.0023.00		VOLVO	1672249
VKHB 2293	MAN	06.32489.0066		VOLVO	1089552
				VOLVO	1587792
				VOLVO	1610765
				VOLVO	16107658





VKS 6136	VOLVO	1594257		FIAT / IVECO	40002851
VKS 6139	VOLVO	6771541		FIAT / IVECO	40002853
VKS 6140	DAF	678157	VKS 6216	FIAT / IVECO	40001933
	RENAULT / RVI	5000788490		FIAT / IVECO	40100110
	VOLVO	6771769	VKS 6218	FIAT / IVECO	40003733
VKS 6142	VOLVO	1667065		FIAT / IVECO	40100670
VKS 6143	MERCEDES BENZ	000 997 14 46	VKS 6219	RENAULT / RVI	5000395649
VKS 6146	MERCEDES BENZ	002 997 65 47		RENAULT / RVI	5000546916
VKS 6148	MERCEDES BENZ	002 997 84 47	VKS 6221	FIAT / IVECO	40001903
	MERCEDES BENZ	002 997 85 47	VKS 6225	FIAT / IVECO	40003723
VKS 6150	MERCEDES BENZ	004 997 18 47		FIAT / IVECO	40100443
	MERCEDES BENZ	019 997 48 47	VKS 6229	RENAULT / RVI	5000391891
VKS 6151	MERCEDES BENZ	004 997 77 45	VKS 6233	RENAULT / RVI	5000785261
VKS 6154	MERCEDES BENZ	006 997 05 46		RENAULT / RVI	5001 858475
VKS 6157	MERCEDES BENZ	007 997 36 46	VKS 6234	RENAULT / RVI	0024 482 709
VKS 6158	MERCEDES BENZ	009 997 67 47		RENAULT / RVI	0024472709
VKS 6159	MERCEDES BENZ	011 997 25 46		RENAULT / RVI	5000787789
VKS 6170	DAF	325321	VKS 6235	RENAULT / RVI	5010443189
VKS 6171	DAF	0190069	VKS 6236	RENAULT / RVI	7701003394
	DAF	190069		RENAULT / RVI	5516015596
VKS 6172	MERCEDES BENZ	010 997 24 47		RENAULT / RVI	5516015596
	MERCEDES BENZ	010 997 87 47	VKS 6237	RENAULT / RVI	5516015599
VKS 6173	MERCEDES BENZ	010 997 01 47		RENAULT / RVI	5000 675 159
	MERCEDES BENZ	010 997 86 47	VKS 6238	RENAULT / RVI	5000392404
VKS 6174	MERCEDES BENZ	009 997 92 47	VKS 6239	FIAT / IVECO	86014686
	MERCEDES BENZ	012 997 11 47		RENAULT / RVI	5000545227
VKS 6175	MERCEDES BENZ	012 997 91 47		MERITOR (ROR)	5000545227
	RENAULT / RVI	0024472569		RENAULT / RVI	5000545227
	RENAULT / RVI	5010067534		VOLVO	947271
VKS 6176	MERCEDES BENZ	005 997 44 46	VKS 6249	SAF	4.373.0010.00
	MERCEDES BENZ	006 997 21 47	VKS 6250	BPW	02.5664.55.64
VKS 6178	MERCEDES BENZ	010 997 79 47		BPW	02.5664.57.00
	MERCEDES BENZ	010 997 84 47	VKS 6251	BPW	02.5664.56.64
	MERCEDES BENZ	011 997 54 46		BPW	02.5664.58.00
VKS 6180	DAF	0292766	VKS 6252	FRUEHAUF	M00-3125
	DAF	292766	VKS 6259	KÄSSBOHRER	4.753.656.000
	FIAT / IVECO	93160832		KÄSSBOHRER	4.753.656.000E
VKS 6181	MAN	06.56289.0334	VKS 6260	MERITOR (ROR)	21220158
	MERCEDES BENZ	013 997 05 47	VKS 6261	SCANIA	375086
	MERCEDES BENZ	013 997 94 47	VKS 6266	DAF	491901
VKS 6182	MAN	06.56281.0605	VKS 6267	DAF	490881
	MAN	06.56289.0315	VKS 6283	FRUEHAUF	A.JA 0564.001
	MAN	06.56289.0324	VKS 6284	SCANIA	375087
VKS 6183	MAN	06.56289.0065	VKS 6285	BPW	02.5664.26.57
	MAN	06.56289.0335	VKS 6286	BPW	02.5664.64.57
	MERCEDES BENZ	013 997 59 47	VKS 6287	BPW	02.5664.46.57
	MERCEDES BENZ	016 997 56 47	VKS 6288	MERCEDES BENZ	012 997 67 47
VKS 6189	MAN	06.56289.0309	VKS 6292	SAF	4.373.0005.00
	MAN	06.56289.0386	VKS 6295	Trailor	43752
VKS 6192	MAN	06.56289.0184	VKS 6296	MAN	06.56289.0320
	MAN	81.96503.0161	VKS 6298	VOLVO	3090331
VKS 6194	MAN	06.56289.0052	VKS 6299	MERCEDES BENZ	014 997 99 47
	MAN	06.56289.0365		MERCEDES BENZ	015 997 01 47
	MERCEDES BENZ	015 997 58 47		MERCEDES BENZ	015 997 46 47
VKS 6201	RENAULT / RVI	0024472667		MERCEDES BENZ	015 997 56 47
	RENAULT / RVI	00671980	VKS 6302	MAN	06.56289.0325
	RENAULT / RVI	5000671980	VKS 6303	RENAULT / RVI	5003087034
	RENAULT / RVI	5010 566 199	VKS 6315	MERCEDES BENZ	021 997 89 47
VKS 6202	RENAULT / RVI	0024472286	VKS 6316	FIAT / IVECO	40102273
	VOLVO	968013	VKS 6326	FIAT / IVECO	40102143
VKS 6205	MERITOR (ROR)	212 00321 A	VKS 6327	MAN	06.56289.0321
	RENAULT / RVI	5001 835 188	VKS 6328	MAN	06.56289.0385
	SAF	4.373.0035.01	VKS 6329	MAN	06.56289.0323
VKS 6207	VOLVO	1593459	VKS 6330	FIAT / IVECO	40102321
VKS 6211	FIAT / IVECO	40100043	VKS 6333	DAF	1238034
	FIAT / IVECO	40100113	VKS 6334	MAN	06.56289.0371
VKS 6214	FIAT / IVECO	2475977		MERCEDES BENZ	020 997 05 47
VKS 6215	FIAT / IVECO	40002850	VKS 6350	MERCEDES BENZ	000 350 10 35

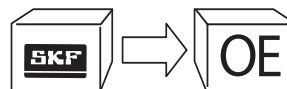
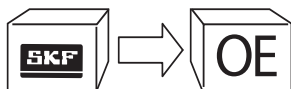

VKS 6351	MERCEDES BENZ	022 997 53 47
VKS 6352	MERCEDES BENZ	022 997 52 47
VKS 6353	MERCEDES BENZ	022 997 59 47
VKS 6354	MERCEDES BENZ	020 997 39 47
VKS 6357	BPW	02.5664.68.00
VKS 6358	DAF	AMPB 584
VKS 6364	DAF	AJU 1901
	FRUEHAUF	M200021-03
	TRAILOR	M200021-03
VKS 6365	FRUEHAUF	M200021-01
	TRAILOR	M200021-01
VKS 6366	FRUEHAUF	M200021-02
	TRAILOR	M200021-02
VKS 6372	SCANIA	1409889
	SCANIA	1534012
VKS 6375	RENAULT / RVI	5010443187



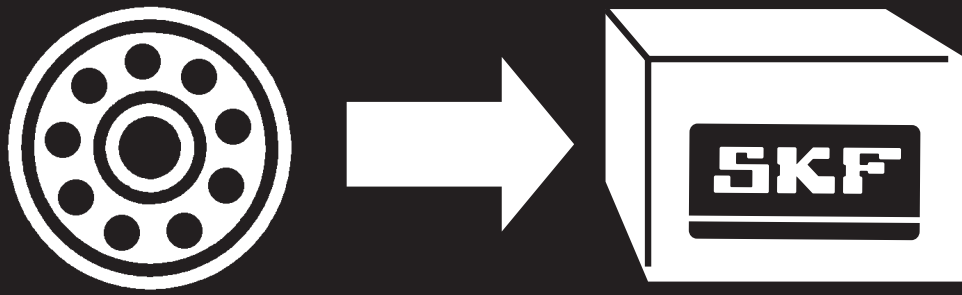

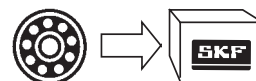
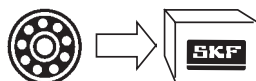
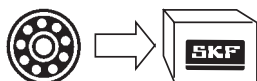

07087 X/K-07210 X	VKHB 2238	32310 TN9	VKHB 2303	39590/39520/Q	VKHB 2175
10R 33108 A	VKHB 2268	32311 J2	VKHB 2002	3955/394A	VKHB 2034
1380/1328/Q	VKHB 2055	32312 J2/Q	VKHB 2003	45291/45220	VKHB 2241
18690/18620/Q	VKHB 2239	32314 BJ2/QCL7C	VKHB 2171	47487/47420	VKHB 2200
18790/18720/Q	VKHB 2246	32314 J2/Q	VKHB 2072	47490/47420	VKHB 2076
25590/25520/Q	VKHB 2309	32924	VKHB 2247	47678/47620/Q	VKHB 2221
2789/2720/QCL7C	VKHB 2054	33011/Q	VKHB 2156	47687/47620/Q	VKHB 2142
30205 J2/Q	VKHB 2189	33012/Q	VKHB 2045	495/493	VKHB 2333
30209 J2/Q	VKHB 2296	33013/Q	VKHB 2047	504376 A	VKHB 2328
30210 J2/Q	VKHB 2167	33014	VKHB 2044	52375/52618	VKHB 2185
30215 J2/Q	VKHB 2168	33015/Q	VKHB 2046	529656	VKHB 2064
30216 J2/Q	VKHB 2204	33016/Q	VKHB 2140	537/532 X/Q	VKHB 2014
30217 J2/Q	VKHB 2334	33017/Q	VKHB 2321	547518	VKHB 2174
30218 J2	VKHB 2248	33018/Q	VKHB 2048	567/563	VKHB 2208
30220 J2	VKHB 2164	33019/Q	VKHB 2082	580/572/Q	VKHB 2041
30221 J2	VKHB 2215	33020/Q	VKHB 2124	594/592 A/Q	VKHB 2040
30305 J2	VKHB 2262	33020/QVB091	VKHB 2145	6379/K-6320/Q	VKHB 2195
30307 J2/Q	VKHB 2202	33021/Q	VKHB 2162	6386/K-6320/Q	VKHB 2013
30309 J2/Q	VKHB 2201	33021/QVB091	VKHB 2146	64432/64708	VKHB 2187
30311 J2/Q	VKHB 2198	33022	VKHB 2163	663/653/Q	VKHB 2043
30312 J2/Q	VKHB 2283	330356 A/Q	VKHB 2079	681 A/672	VKHB 2141
30313 J2/Q	VKHB 2304	331074/Q	VKHB 2081	683/372	VKHB 2042
32006 X/Q	VKHB 2267	33108/Q	VKHB 2190	687/672	VKHB 2143
32008 X/Q	VKHB 2188	33109/Q	VKHB 2056	801785	VKHB 2307
32010 X/Q	VKHB 2191	33111 JR	VKHB 2318	BT1-0084/Q	VKHB 2280
32010 X/QCL7CVB026	VKHB 2275	33111/Q	VKHB 2059	BT1-0163/Q	VKHB 2315
32011 X/Q	VKHB 2060	33112/QVB259	VKHB 2233	BT1B 328251/Q	VKHB 2240
32012 X/QCL7C	VKHB 2234	33113/Q	VKHB 2214	BT1B 328286/Q	VKHB 2293
32013 X/Q	VKHB 2199	33113/QVB022	VKHB 2159	BT1B 329138/34478/2/QVQ276	VKHB 2209
32014 X/Q	VKHB 2154	33115/Q	VKHB 2222	BT1B 639416 A/Q	VKHB 2279
32015 X/Q	VKHB 2282	33116 TN9/QCLNVB091	VKHB 2298	BT1B 639417/Q	VKHB 2053
32016 X/Q	VKHB 2157	33116 TN9/QVT621	VKHB 2177	CK-598 A/K-592 A	VKHB 2083
32017 X/Q	VKHB 2169	33116/Q	VKHB 2326	H 212749/H 212710	VKHB 2332
32018 X/Q	VKHB 2170	33117/Q	VKHB 2158	HM 212049/HM 212011	VKHB 2286
32019 X/Q	VKHB 2161	33118 TN9/QVT621	VKHB 2178	HM 215249/HM 215210	VKHB 2050
32020 X/Q	VKHB 2306	33118/Q	VKHB 2331	HM 218248/W/2A/210/2A/Q	VKHB 2029
32021 X/528595	VKHB 2323	331293/Q	VKHB 2155	HM 220149 A/W/110/QV002	VKHB 2032
32021 X/Q	VKHB 2160	331974 A/Q	VKHB 2172	HM 220149/HM 220110/Q	VKHB 2285
32022 X/Q	VKHB 2281	33205/QVQ077	VKHB 2057	HM 518445/410	VKHB 2227
32024 X	VKHB 2216	33206/Q	VKHB 2179	JF 9549/9510	VKHB 2192
32206 J2/Q	VKHB 2016	33207/Q	VKHB 2182	JH211749/JH211710	VKHB 2287
32207 J2/Q	VKHB 2018	33208 JR-1/33208 J	VKHB 2320	JH415647-99401	VKHB 2203
32208 J2/Q	VKHB 2020	33208/Q	VKHB 2065	JHM 720249/JHM 720210	VKHB 2186
32209 J2/Q	VKHB 2015	33209/Q	VKHB 2067	JLM 714149/JLM 714110	VKHB 2338
32210 J2/Q	VKHB 2017	33210/Q	VKHB 2068	JM 205149/110/Q	VKHB 2023
32211 J2/Q	VKHB 2019	33211/Q	VKHB 2061	JM 511946/JM 511910/Q	VKHB 2243
32213 J2/Q	VKHB 2288	33212/Q	VKHB 2173	JM 515649/610/Q	VKHB 2205
32214 J2/Q	VKHB 2284	33213 JR	VKHB 2319	JM 714249/210/Q	VKHB 2137
32215 J2/Q	VKHB 2033	33213 TN9/QVT621	VKHB 2217	JM 718149 A/110/Q	VKHB 2226
32216 J2/Q	VKHB 2026	33213/Q	VKHB 2051	JM207049-90N90	VKHB 2021
32217 J2/Q	VKHB 2080	33214/Q	VKHB 2066	JT 9049/9010	VKHB 2337
32218 J2/Q	VKHB 2030	33215/Q	VKHB 2028	JXC 25678 CA	VKHB 2302
32219 J2	VKHB 2031	33216/Q	VKHB 2194	JXC 25716 C/JXC 25716 D	VKHB 2253
32219 J2/VB129	VKHB 2210	33216/QVB091	VKHB 2232	JXC25370CA-90KA2	VKHB 2250
32220 J2	VKHB 2297	33217/Q	VKHB 2225	K-387 A/K-382	VKHB 2276
32221 J2	VKHB 2212	33220	VKHB 2165	KHM.220110/567549	VKHB 2329
32304 J2/Q	VKHB 2058	332330 B/Q	VKHB 2071	L 68149/110/Q	VKHB 2237
32305 J2	VKHB 2294	33287/33462/Q	VKHB 2311	LM 11949/910/Q	VKHB 2270
32306 J2/Q	VKHB 2007	33895/33822/Q	VKHB 2075	LM 12749/710/Q	VKHB 2271
32306 JR	VKHB 2317	3490/3420	VKHB 2242	LM 300849/811/QCL7A	VKHB 2272
32307 J2/Q	VKHB 2063	3585/3525/Q	VKHB 2089	LM 48548/510/Q	VKHB 2151
32308 J2/Q	VKHB 2001	368 A/362 A/Q	VKHB 2258	LM 501349/310/Q	VKHB 2153
32309 BJ2/QCL7C	VKHB 2236	3780/3720/Q	VKHB 2310	M 12649/610/Q	VKHB 2152
32309 J2/Q	VKHB 2004	387 A/382 A/Q	VKHB 2277	R 32217 J2/VB128/L 32217/Q	VKHB 2211
32310 J2/Q	VKHB 2070	39580/W/2/39520/2/Q	VKHB 2036	R 33114/QCLNVQ276/	
32310 J2/QU4	VKHB 2299	39581/39520/Q	VKHB 2088	L 33114/QCLNVQ276	VKHB 2252

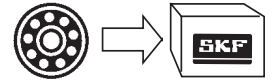
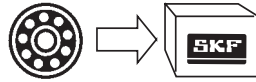
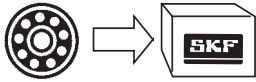



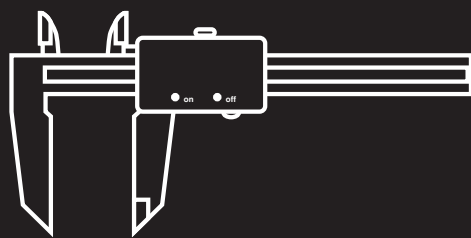

R 33209/QCLNVB323/
L 33209/QCLNVQ276
R 33211/QCLNVB324/
L 33211/QCLNVQ276
T2ED 045
T2ED 050/Q
T2ED 055/QCLN
T2ED 070/QCLNVB061
T2EE 060/Q
T2EE 100
T3FE 075/QVB481
XAA32008 X/Y32008X
XC 8640 CD/HM 220110

VKHB 2249
VKHB 2339
VKHB 2184
VKHB 2255
VKHB 2006
VKHB 2024
VKHB 2228
VKHB 2147
VKHB 2231
VKHB 2266
VKHB 2305

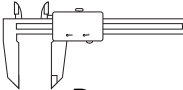

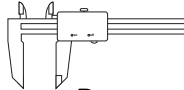

 				 			
d	D	W		d	D	W	
44,0	85,0	10,0/8,0	VKS 6229	117,4	142,8	12,7	VKS 6108
53,0	97,0	8,0	VKS 6219	118,0	152,0	27,0	VKS 6205
58,0	80,0	12,0	VKS 6236	120,0	140,0	15,5/13,5	VKS 6303
62,0	80,0	10,0	VKS 6299	120,0	145,0	14,2	VKS 6352
70,0	81,5	6,0	VKS 6146	120,0	145,0	15,0	VKS 6154
70,0	90,0	14,5/13,5	VKS 6316	120,0	150,0	15,0	VKS 6150
72,0	100,0	10,0	VKS 6170	120,0	150,0	15,5/13,5	VKS 6234
75,0	95,0	13,0	VKS 6159	120,0	160,0	15,0	VKS 6201
75,0	100,0	12,0	VKS 6148	120,0	160,0	17,0	VKS 6140
75,0	100,0	13,0	VKS 6143	125,0	143,0	13,0	VKS 6285
75,0	100,0	14,0/10,0	VKS 6105	125,0	150,0	13,0	VKS 6216
78,0	103,0	18,0	VKS 6298	125,0	150,0	14,0	VKS 6351
80,0	100,0	10,0/9,5	VKS 6238	125,0	150,0	15,0/13,0	VKS 6176
80,0	100,0	12,0/9,5	VKS 6288	125,0	160,0	15,0	VKS 6261
81,0	100,0	10,0	VKS 6296	125,0	160,0	17,0	VKS 6180
85,0	110,0	13,0	VKS 6235	130,0	160,0	16,0	VKS 6328
86,0	105,0	6,0/5,0	VKS 6315	133,3	155,6	14,0	VKS 6114
87,3	120,7	17,8	VKS 6192	135,0	156,7	10,5/8,0	VKS 6251
90,0	110,0	12,0	VKS 6266	135,0	165,0	17,0	VKS 6139
90,0	110,0	13,0	VKS 6173	137,0	161,9	20,0/15,0	VKS 6109
90,0	110,0	13,5	VKS 6221	140,0	160,0	13,0	VKS 6249
90,0	110,0	10,0/9,5	VKS 6327	140,0	160,0	13,0/12,0	VKS 6233
90,0	130,0	17,0	VKS 6267	140,0	164,0	22,0/20,0	VKS 6132
95,0	110,0	10,0/9,5	VKS 6239	142,0	170,0	16,0	VKS 6372
95,0	115,0	10,0	VKS 6302	145,0	167,0	13,0	VKS 6287
95,0	115,0	13,0	VKS 6172	145,0	170,0	20,0/15,0	VKS 6111
95,0	120,0	10,0	VKS 6329	145,0	175,0	13,0	VKS 6181
95,0	120,0	13,0/12,0	VKS 6174	145,0	175,0	14,0	VKS 6183
95,0	130,0	16,0	VKS 6326	145,0	175,0	16,0	VKS 6189
97,0	157,0	17,5	VKS 6354	145,0	175,0	17,0	VKS 6136
100,0	120,0	12,0	VKS 6202	145,0	175,0	17,0	VKS 6353
100,0	120,0	13,0	VKS 6157	145,0	205,0/175,0	20,0/18,0	VKS 6334
100,0	125,0	13,0	VKS 6175	160,0	180,0	10,0	VKS 6194
100,0	130,0	12,0	VKS 6182	160,0	180,0	15,0	VKS 6292
100,0	130,0	12,5	VKS 6375	160,0	188,0	14,0	VKS 6286
100,0	130,0	13,0	VKS 6158	168,0	192,5	30,0/12,0	VKS 6135
100,0	130,0	13,5	VKS 6211	180,0	200,0	12,0	VKS 6218
100,0	130,0	17,0	VKS 6357	180,0	200,0	12,0	VKS 6225
100,0	135,0	15,0/13,0	VKS 6260				
100,0	140,0	15,0	VKS 6259				
100,0	140,0	17,0	VKS 6207				
100,0	140,0	20,5/15,0	VKS 6333				
105,0	130,0	12,0	VKS 6358				
105,0	136,0	13,0	VKS 6215				
107,5	153,0	25,0	VKS 6283				
107,6	188,0/152,6	19,5	VKS 6252				
110,0	130,0	12,0	VKS 6142				
110,0	130,0	12,0	VKS 6350				
110,0	130,0	13,0	VKS 6237				
110,0	140,0	15,0	VKS 6284				
110,0	140,0	19,0/12,0	VKS 6134				
110,0	146,0	27,0	VKS 6295				
110,0	152,6	16,5	VKS 6364				
110,0	152,6	19,5	VKS 6365				
110,0	152,6	19,5	VKS 6366				
114,0	152,0	14,8	VKS 6330				
114,0	170,0/141,5	27,0	VKS 6171				
115,0	136,7	12,0/8,0	VKS 6250				
115,0	140,0	13,0/12,0	VKS 6178				
115,0	150,0	13,0	VKS 6151				
117,0	152,0	22,0	VKS 6214				



English.....	324
Deutsch.....	332
Français.....	340
Italiano.....	348
Español.....	356

Nederlands.....	364
Polski.....	372
Svenska.....	380
Suomi.....	388

How to use this catalogue

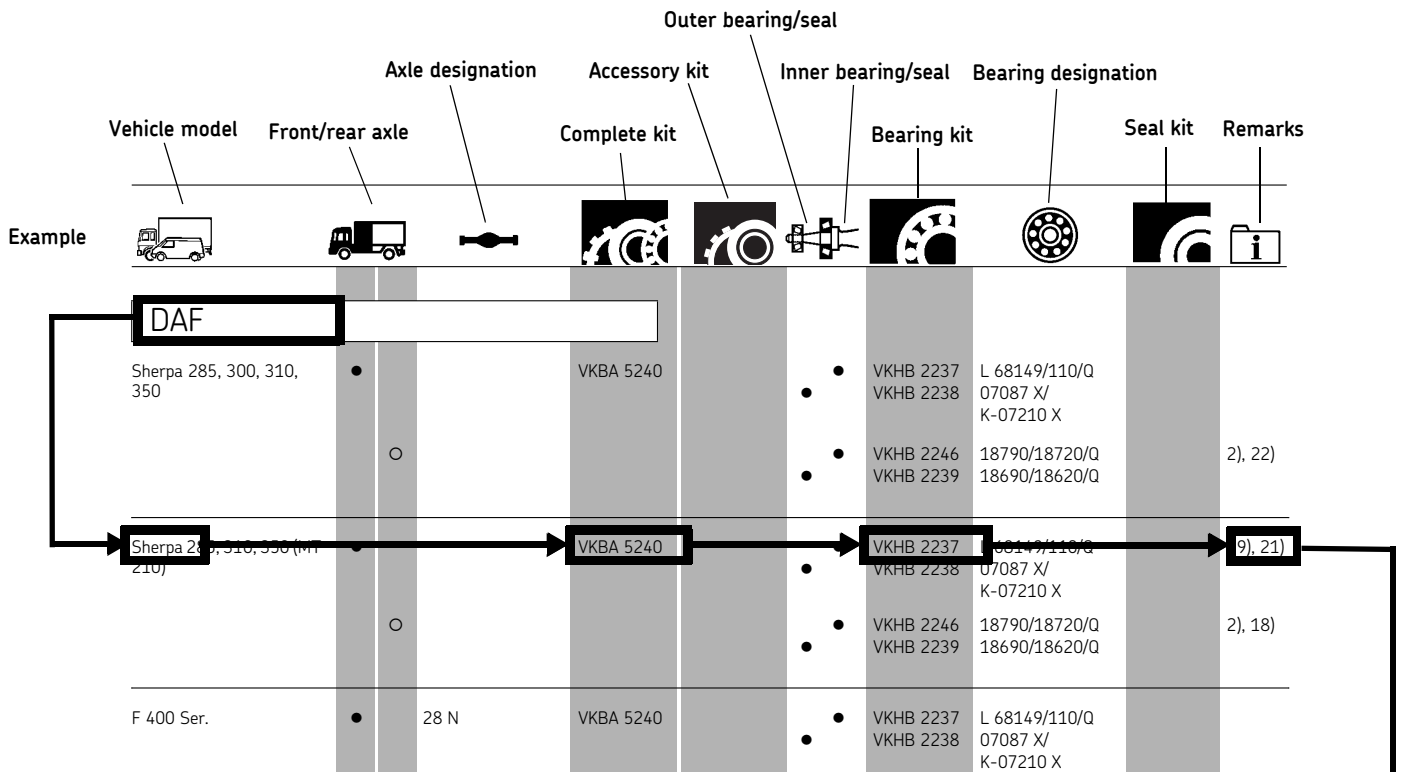













Contents of kits

	A	B	C	D	E	F	G	H	I	J	K	L			
VKA 4004							1		1				VOLVO	●	○
VKA 4026							1		1				VOLVO		○
VKA 4036							2	1					SCANIA		○
VKA 4038							1	1					SCANIA		○
VKA 4094							2	1					MERCEDES-BENZ	●	○
VKA 4095							1	2					MERCEDES-BENZ	●	○

A	B	C	D	E	F	G	H	I	J	K	L
Bearing	Locking washer	Nut	Spacer	Locking ring	Circlip	Oil seal	Gasket	O-ring	Shield plate	Split pin	Various

VKBA = VKHB + VKHB + VKA/VKS

						
						
VKBA 5025 VKBA 5026	VKHB 2056 VKHB 2059	VKHB 2057 VKHB 2007	VKS 6290			

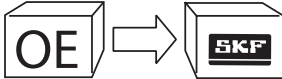
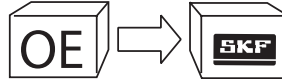
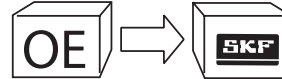

Conversion list OE – reference SKF

		
BPW		FIAT / IVECO
02.5664.26.57 02.5664.46.57 02.5664.55.57	0174592 0174595 0190069 0221664 0266487	1101597 1102042
VKS 6285 VKS 6287 VKS 6250 VKS 6251	VKHB 2043 VKHB 2141 VKS 6171 VKHB 2222 VKHB 2223	VKHB 2060 VKHB 2282 VKHB 2283

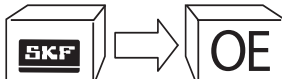
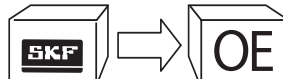



Conversion list SKF - OE

	
VKBA 519	VKBA 3616
VW VW FORD FORD MERCEDES BENZ	RENAULT / RVI OPEL OPEL OPEL
211 498 071 211 498 071 BS 5 007 029 5 007 028 116 320 00 51	77 01 206 742 44 08 669 91160087 77 01 206 848 116 320 00 51
VKBA 519 VKBA 523 VKBA 528	VKHB 2175 VKHB 2176 VKHB 2177

Bearing - SKF VKHB

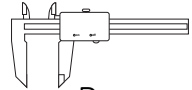
		
07087 X/K-07210 X 10B 3000	VKHB 2238 VKHB 2268	VKHB 2175 VKHB 2176 VKHB 2177
32310 TN9 32311 12	VKHB 2303 VKHB 2304 VKHB 2305	30500/39520/Q

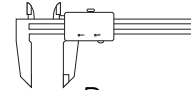
Dimensional search (seals)

					
d	D	W	d	D	W
44,0 53,0	85,0 97,0	10,0/8,0 8,0 12,0	117,4 118,0	142,8	12,7 27,0
		VKS 6229 VKS 6219			VKS 6108 VKS 6109

ENGLISH



Symbols

Symbols for catalogue sections



New kits and replacements



Vehicle applications, trucks



Vehicle applications, buses



Vehicle application, trailers



Kit contents



VKBA=VKHB+VKHB+VKA/VKS



Conversion list OE - SKF



Conversion list SKF - OE



Bearing - SKF VKHB



Dimensional search (seals)

Universal symbols



Up to



From



Replacement kits



Deleted kits



Tools

Abbreviation

Ch.	Chassis reference
Forward rear axle	Forward rear axle
Rear rear axle	Rear rear axle
Trailing axle	Trailing axle

VKBA XXXX	In production
VKHB XXXX	In production
VKA XXXX	In production
VKS XXXX	In production
VKN XXX	In production

Remarks

BPW

- 1) Lowloader
- 2) Except lowloader

CITROËN

- 1) 09/81 - 12/89, Ch.-604496
- 2) 01/89 - 03/04, Ch.604497 -
- 3) 02/91 - 03/94
- 4) 01/87 - 12/89, Ch.-604496
- 5) 01/89 - 02/94, Ch. 604497 -
- 6) 09/81 - 12/86, left wheel, Ch.-289710, payload : 1000, 1300 Kg
- 7) 09/81 - 12/86, right wheel, Ch.-289710, payload : 1000, 1300 Kg
- 8) 09/81 - 03/94, Left wheel, payload :1800 Kg
- 9) 09/81 - 03/94, Right wheel, payload : 1800 Kg
- 10) 01/86 - 03/94, Left wheel, Ch.289711-, payload : 1000, 1300, 1400 Kg
- 11) 01/86 - 03/94, Right wheel, Ch.289711-, payload : 1000, 1300, 1400 Kg
- 12) 01/87 - 02/94,
- 13) 02/94 - 04/02, Ch.-16194399, payload :1000, 1400 Kg
- 14) 02/94 - 04/02, Ch.-16194399, payload : 1800 Kg
- 15) 02/94 - 04/02, Ch.16194400 -, payload : 1000, 1400 Kg
- 16) 02/94 - 04/02, Ch.16194400 -, payload : 1800 Kg
- 17) 04/02 - 09/04, payload : 1000, 1400 Kg
- 18) 04/02 - 09/04, payload : 1800 Kg
- 19) 03/94 - 04/02, Ch.-16194399, payload : 1000, 1400 Kg
- 20) 03/94 - 04/02, Ch.-16194399, payload : 1800 Kg
- 21) 03/94 - 04/02, Ch.16194400 -, payload : 1000, 1400 Kg
- 22) 03/94 - 04/02, Ch.16194400 -, payload : 1800 Kg
- 23) 08/96 - 04/02, Ch.-16194399, payload : 1000, 1400 Kg
- 24) 08/96 - 04/02, Ch.-16194399, payload : 1800 Kg
- 25) 08/96 - 04/02, Ch.16194400 -, payload : 1000, 1400 Kg
- 26) 08/96 - 04/02, Ch.16194400 -, payload : 1800 Kg
- 27) 02/94 - 04/02, Ch.16194400 -
- 28) Drum brakes
- 29) Disc brakes

DAF

- 2) Dual rear wheel
- 3) Track width 1718 mm, with 10 bolts hub
- 4) Track width 1655 mm, with 8 bolts hub
- 5) Except hub centration
- 6) With hub centration
- 7) With hub centration. Black seal
- 8) With hub centration. Blue seal

- 9) With hub reduction
- 10) Except FAR
- 11) With FAR
- 12) Except FA, FT
- 13) With FA, FT
- 14) Except hub centration. Black seal
- 15) Except hub centration. Blue seal
- 16) Black seal
- 17) Blue seal
- 18) 1983-85
- 19) Ch.237886-, single rear wheel
- 21) 1984-85
- 22) 1985-12/89
- 23) -12/89
- 24) Oil Seal/ABS-ring not integrated

FIAT-IVECO

- 4) Left wheel
- 5) Right wheel
- 8) Left wheel, 06/79-06/81
- 9) Right wheel, 06/79-06/81
- 10) 10/77-06/81
- 11) Left wheel, 06/81-09/84
- 12) Right wheel, 06/81-09/84
- 13) 06/81-09/84
- 14) Left wheel, 10/84-88
- 15) Right wheel, 10/84-88
- 16) 10/84-88
- 17) 03/85-88
- 18) Ch.-604496, 1982-89
- 19) Ch.604497-, 1989-93
- 20) Left wheel, ch.-278757, 1982-86
- 21) Right wheel, ch.-278757, 1982-86
- 22) Left wheel, ch.278758-, 1986-93
- 23) Right wheel, ch.278758-, 1986-93
- 24) 1982-86
- 25) Ch.-604496, 1986-89
- 26) Left wheel, 1986-93
- 27) Right wheel, 1986-93
- 28) 10/77-12/86
- 29) 01/87-
- 30) Except 50-9 D, 50-9 V
- 31) 04/91-04/92
- 32) 01/85-
- 33) Disc brakes
- 34) 12/85-
- 36) 1991-94
- 37) Left wheel, 1991-94
- 38) Right wheel, 1991-94
- 39) Except ABS
- 40) Except models for Switzerland
- 41) Models for Switzerland
- 42) Ratio 4.23/1
- 43) Except ratio 4.23/1
- 44) Ratio 4.23/1. Except models for Switzerland
- 45) Except ratio 4.23/1. Except models for Switzerland
- 46) Except ratio 3.79/1
- 47) Ratio 3.79/1
- 48) Ch. -173788
- 49) Ch.173789-. Axle -1824487
- 50) Ch.173789-. Axle 1824488-
- 51) Ch.173789-
- 52) 95 mm inner bearing bore diameter

- 53) 105 mm inner bearing bore diameter. Axle -1824487
- 54) 105 mm inner bearing bore diameter. Axle 1824488-
- 55) Steering axle. Non-steering axle, spare part No 7177196
- 56) Non-steering axle, Spare part No 7177168
- 57) 100 mm inner bearing bore diameter
- 58) Axle -1824487
- 59) Axle 1824488-
- 60) Left wheel, 06/79-01/97
- 61) Right wheel, 06/79-01/97
- 62) 06/81-01/97
- 63) Left wheel, 06/81-88
- 64) Right wheel, 06/81-88
- 65) Except ratio 5.22/1. -02/96
- 66) Ratio 5.22/1. -02/96
- 67) Left wheel, 06/79-02/96
- 68) Right wheel, 06/79-02/96
- 69) 10/77-09/84
- 70) Except "Iveco check control"
- 71) "Iveco check control"
- 72) Left wheel, -02/96
- 73) Right wheel, -02/96
- 74) -2/96
- 75) Ratio 5.62/1
- 76) Except ratio 5.62/1
- 77) ABS
- 78) Left wheel, 03/85-88
- 79) Right wheel, 03/85-88
- 81) 02/96
- 82) 03/96-
- 83) 1994-
- 84) 1996-
- 85) Single row taper roller bearings
- 86) Double row taper roller bearing
- 87) Non-steering axle
- 88) Steering axle
- 89) Front wheel drive
- 90) Except front wheel drive
- 91) Left front wheel, single row taper roller bearing, 03/96 - 12/99
- 92) Right front wheel, single row taper roller bearing, 03/96 - 12/99
- 93) Double row taper, 03/96 - 12/99
- 94) Up to 05/89
- 95) 06/89 - 01/97
- 96) 01/96 - 12/99
- 97) Up to 12/99
- 98) 05/99 - 08/03
- 99) 06/81 - 01/97
- 100) 04/02 - 01/04
- 101) 07/02 - 01/04
- 102) Payload 1100, 1500 Kg
- 103) Payload 1800 Kg

FORD

- 1) 1965-91
- 2) 07/74-12/77
- 3) 08/65-12/77
- 6) 11/73-12/77
- 7) 01/78-10/85
- 8) Left wheel, 11/85-91
- 9) Right wheel, 11/85-91



Remarks

- 10) 11/85-91
- 11) 1992-97
- 12) 01/81-03/87
- 13) 03/87-12/92
- 14) 04/82 - 09/87
- 15) 10/87 - 12/90 Left wheel
- 16) 10/87 - 12/90 Right wheel
- 18) 01/00 - 10/04
- 19) 01/00 - 10/04, non ABS, payload 1000 Kg, FWD
- 20) 01/00 - 10/04, ABS, payload 1000 Kg, FWD
- 21) 07/03 - 10/04, non ABS, payload 2000 Kg, FWD
- 22) 07/03 - 10/04, ABS, payload 2000 Kg, FWD
- 23) 01/00 - 10/04, single wheel, RWD
- 24) 01/00 - 10/04, twin wheels, RWD
- 25) 03/04 - 10/04, non ABS, payload 2000 Kg
- 26) 03/04 - 10/04, ABS, payload 2000 Kg

GIGANT (SAE)

- 1) Air suspension Type N
- 2) Protec axle

FRUEHAUF

- 1) 107, 6 mm axle, with brakes C1/C2
- 2) 110 mm axle, with brakes D1/K1/H1
- 3) 110 mm axle, with brakes C1/C2/L1/L2 (100 teeth)
- 4) 110 mm axle, with brakes C3/C5, (80 teeth)

MAN

- 1) -11/93
- 2) 12/93-
- 3) W25/86-W27/90
- 4) W28/90-
- 5) Non ABS
- 6) ABS
- 7) 01/90-
- 8) Hub. 81.35701.0081
- 9) Hub. 81.35701.0127
- 10) 20" TRILEX
- 11) Hub. 81.35701.0141
- 12) Except "TRILEX"
- 13) "TRILEX"
- 14) -W18/94
- 15) W19/94-
- 16) -W27/96
- 17) W28/96-, 19.5" hub
- 18) W28/96-, 20/22.5" hub

MERCEDES-BENZ

- 1) 02/88 - 02/96
- 2) 02/88 - 02/96, Ch.-128165
- 3) 1983-94
- 4) Ch.-48630
- 5) Ch.48631-

- 6) Diesel engine ch.-17768, petrol engine ch.-1288
- 7) Diesel engine ch.17768-78114, petrol engine ch.1289-4706
- 8) Diesel engine ch.78115-, petrol engine ch.4707-
- 9) 55 mm inner bearing bore diameter
- 10) Axle -1358880
- 11) Axle 1358881-
- 12) 02/88 - 02/96, Ch.128166-
- 13) Axle -1278813
- 14) Axle 1278814-
- 15) 02/88 - 05/92, Flatbed
- 16) 02/73 - 12/77
- 17) 01/95 - 05/02, to axle: S213915/Y245976
- 18) 01/95 - 05/02
- 19) Axle -1390839
- 20) Axle 1390840-
- 21) Axle -1278313
- 22) Axle 1278314-
- 23) 02/95 - 07/04, to axle: S231915/Y245976
- 24) Drum brake
- 25) With ABS, axle -021298
- 26) With ABS, axle 021299-
- 27) Axle -724723
- 28) Axle 724724-
- 29) Hub: 355 356 44 01
- 30) Hub: 346 356 30 01
- 31) 02/95 - 07/04
- 32) 02/96 - 05/02, To axle: S231915/Y245976
- 33) 02/96 - 05/02,
- 34) 09/96 - 07/04
- 35) 02/96 - 07/04
- 37) Hub: 668 356 01 01, 668 356 02 01
- 38) Hub: 972 356 01 01
- 39) Hub: 976 356 11 01
- 40) Hub: 678 356 04 01
- 41) Hub: 675 356 01 01
- 42) Disc brake
- 43) Hub: 942 334 08 01
- 44) Hub: 942 334 07 01, 949 334 05 01

MERITOR (ROR)

- 1) Grease lubricated

MONTENEGRO

- 1) Axle 061001243, 061001243A
- 2) Axle 06-1-1068
- 3) Axle 06-1-1176, 061001231
- 4) Axle 061001271
- 5) Axle 061001231A
- 6) Axle 061001230, 061001230A
- 7) Axle 06-1-1025
- 8) Axle 061001170A
- 9) Axle 061001299
- 10) Axle 061001210, 061001210B, 061001295
- 11) Axle 06-1-1103, 06-1-1170
- 12) Axle 06-1-1100, 06-1-1102, 06-1-1106, 06-1-1108, 06-1-1173, 06-1-1174

OPEL

- 1) 09/00 - 10/01, Wheel diameter (inches):15, Ch.-B 000010, Engine code:F9Q-770
- 2) 09/00 - 10/01, Wheel diameter (inches):15, Ch. B 000011-, Engine code: F9Q-770
- 3) 07/98 - 10/01, Wheel diameter (inches):16
- 4) 07/98 - 10/01, Flatbad, Wheel diameter (inches):15, Ch.-B 0000514, B 006055, Engine code: S8U-702
- 5) 07/98 - 10/01, Box, Bus, Dumpertruck, Wheel diameter (inches): 15, Ch.-B 051615, Engine code: S9W-702
- 6) 07/98 - 10/01, Flatbad, Wheel diameter (inches):15, Ch.B 0000515-, B 006056-, Engine code: S8U-702
- 7) 07/98 - 10/01, Box, Bus, Dumpertruck, Wheel diameter (inches):15, Ch.B 051616-, Engine code:S9W-702
- 8) 07/98 - 10/01, Wheel diameter (inches):15
- 9) 07/98 - 10/01, Wheel diameter (inches):16
- 10) 08/01 - 08/05, Except ABS, Ch.- 3V613233
- 11) 08/01 - 08/05, With ABS, Ch.- 3V613233
- 13) 08/01 - 08/05

PEUGEOT

- 1) 01/83 - 11/88
- 2) 10/90 - 01/01
- 3) 09/81 - 12/89, Ch.-604496
- 4) 01/89 - 09/90, Ch.604497-
- 5) 09/81 - 12/85, Left wheel, payload 1000 Kg, 1300 Kg, Ch.-244300
- 6) 09/81 - 01/01, Left wheel, payload 1400 Kg
- 7) 09/81 - 01/01, Left wheel, payload 1800 Kg
- 8) 09/81 - 01/01, Right wheel, payload 1400 Kg
- 9) 09/81 - 01/01, Right wheel, payload 1800 Kg
- 10) 01/86 - 11/88, Left wheel, payload 1000 Kg, 1300 Kg, Ch. 244301-
- 11) 09/81 - 12/85, Right wheel, payload 1000 Kg, 1300 Kg, Ch.-244300
- 12) 01/86 - 11/88, Right wheel, payload 1000 Kg, 1300 Kg, Ch.244301-
- 13) 10/90 - 01/01, Left wheel, payload 1000 Kg, 1300 Kg
- 14) 10/90 - 01/01, Right wheel, payload 1000 Kg, 1300 Kg
- 15) 1967-09/70
- 16) 10/70-80
- 17) 1967-80
- 18) 1980-88
- 19) 03/94 - 04/02, payload 1000 Kg, 1400 Kg, Ch.-16194399
- 20) 03/94 - 04/02, payload 1800 Kg, Ch.-16194399
- 21) 03/94 - 04/02, payload 1000 Kg, 1400 Kg, Ch.16194400-
- 22) 03/94 - 04/02, payload 1800 Kg, Ch.16194400-
- 23) 04/02 - 07/04, payload 1000 Kg, 1400 Kg
- 24) 04/02 - 07/04, payload 1800 Kg
- 25) 07/96 - 04/02, payload 1000 Kg, 1400 Kg, Ch.-16194399

Remarks

26) 07/96 - 04/02, payload 1800 Kg, Ch.-16194399	61) -05/95	127) 03/01 - 02/04
27) 07/96 - 04/02, payload 1000 Kg, 1400 Kg, Ch.16194400-	62) 06/95-	128) 08/80 - 07/98, Box, Bus
28) 07/96 - 04/02, payload 1800 Kg, Ch.16194400-	63) Drum brakes	129) 09/80 - 07/98, Flatbad
29) 03/04 - 04/02, Ch.16194400-	64) Disc brakes	130) 07/98 - 03/00
30) 04/02 - 07/04	65) -2/85	131) 03/00 - 02/02
31) 10/01 - 04/02	66) 03/85-	132) 07/98 - 01/01
32) 11/00 - 09/01, payload 1000 Kg, 1400 Kg	67) -17/11/93	133) 07/98 - 10/01, Box, Bus
33) 11/00 - 09/01, payload 1800 Kg	68) 18/11/93-	134) 07/98 - 10/01, Box, Flatbad
34) 07/96 - 04/02, Drum brake	69) 10/87-	135) 09/00 - 02/04, Box, Drum brakes
35) 07/96 - 04/02, Disc brake	70) ABS	136) 09/00 - 02/04, Box, Disc brakes
36) 01/86 - 01/01, Left wheel, payload 1000 Kg, 1300 Kg, Ch.244301-	71) -12/92	137) 09/00 - 02/04, Bus, Drum brakes
37) 01/86 - 01/01, Right wheel, payload 1000 Kg, 1300 Kg, Ch.244301-	72) 01/93 - 17/08-98	138) 09/00 - 02/04, Bus, Disc brakes
	73) 01/77-14/03/84	139) 09/00 - 02/04, Flatbed, Drum brakes
	74) 03/86-	140) 09/00 - 02/04, Flatbed, Disc brakes
	75) Except ABS. -08/91. Except "Trilex".	141) 07/98 - 01/01, Box, Drum brakes
	76) ABS. -08/91. Except "Trilex".	142) 07/98 - 01/01, Box, Disc brakes
	77) "Trilex"-20". -03/93.	143) 10/01 - 02/04, Box, Drum brakes
	78) "Trilex"-24". -03/93.	144) 10/01 - 02/04, Box, Disc brakes
	79) 09/91-03/93. Except "Trilex".	145) 07/98 - 01/01, Bus, Drum brakes
	80) -2/86	146) 07/98 - 01/01, Bus, Disc brakes
	81) -12/87	147) 10/01 - 02/04, Bus, Drum brakes
	82) Locking nut M75. -05/91	148) 10/01 - 02/04, Bus, Disc brakes
	83) Locking nut M70. -05/91	149) 07/98 - 01/01, Flatbed, Drum brakes
	84) Except ABS	150) 07/98 - 01/01, Flatbed, Disc brakes
	85) With ABS	151) 10/01 - 02/04, Flatbed, Drum brakes
	86) -05/95	152) 10/01 - 02/04, Flatbed, Disc brakes
	87) 06/95-	153) 07/98 - 10/01, Box, Drum brakes
	88) -03/89	154) 07/98 - 10/01, Box, Disc brakes
	89) 04/89-	155) 07/98 - 10/01, Flatbed, Drum brakes
	90) 1973-1989	156) 07/98 - 10/01, Flatbed, Disc brakes
	91) Except engine G9T	157) 10/03 - 02/04, Box, Drum brakes
	92) With engine G9T	158) 10/03 - 02/04, Box, Disc brakes
	96) 03/89 - 04/89, Box, Bus, inner bearing 35x72x24.5 mm	159) 10/03 - 02/04, Bus, Drum brakes
	97) 03/89 - 04/89, Box, Bus, inner bearing 35x62x18.3 mm	160) 10/03 - 02/04, Bus, Disc brakes
	98) 05/89 - 10/97, Flatbed	161) 10/03 - 02/04, Flatbed, Drum brakes
	100) 03/80 - 04/89, Box, Bus	162) 10/03 - 02/04, Flatbed, Disc brakes
	101) 03/80 - 04/89, Flatbed	
	102) 18/08/98 -	
	103) - 31/03/98	
	104) 01/04/98 -	
	105) - 27/08/98	
	106) - 24/08/98	
	107) - 17/08/98	
	108) Single wheel	
	109) Twin wheel	
	110) 01/09/91 - 31/03/93	
	111) - 11/04/2000	
	112) 12/04/2000 -	
	113) 03/80 - 04/89	
	114) 03/80 - 12/83, Box, Bus	
	115) 03/80 - 02/89	
	116) 01/84 - 12/85, Box, Bus	
	117) 01/86 - 02/89, Box, Bus	
	118) 03/89 - 04/89	
	119) 05/89 - 01/01, Box, Bus	
	120) 05/89 - 01/01	
	121) 05/89 - 01/01, Flatbed, Model type:PC	
	122) 05/89 - 01/01, Box, Bus, inner bearing 35x72x24.5 mm	
	123) 05/89 - 01/01, Box, Bus, inner bearing 35x62x18.3 mm	
	124) 03/01 - 11/02, Except ABS	
	125) 03/01 - 11/02, with ABS	
	126) 11/02 - 02/04	

RVI

- 12) -14/06/85
- 13) 17/06/85-
- 14) -12/82
- 15) 01/83-
- 16) -15/11/85
- 17) 18/11/85-
- 18) -1986
- 19) 1987-
- 22) 07/86-
- 23) -14/03/84
- 24) 15/03/84-
- 25) 10/84-01/86
- 26) 02/86-
- 27) -09/84
- 28) -01/86
- 29) 10/84-
- 30) -09/83
- 31) 10/83-
- 33) -08/79
- 34) 09/79-
- 35) -08/84 MOT 62030
- 36) -12/83
- 37) 01/84-
- 38) -12/85
- 39) 01/86-
- 40) 12/92-
- 41) -05/91
- 42) 06/91-03/93
- 43) 04/93-
- 44) -08/84 MOT 62030. -N
- 45) -08/84 MOT 62030. N 1540
- 47) 09/93-
- 48) Except ABS. -08/91
- 49) ABS. -08/91
- 50) 09/91-03/93
- 51) 09/91-
- 52) -03/93
- 53) -08/91
- 54) -07/90
- 55) 08/90-
- 56) -02/91
- 57) 03/91-
- 58) -09/90
- 59) -02/92
- 60) 03/92-

SCANIA

- 1) Ch.-1032241
- 2) Ch.1032242-
- 3) Disc wheels, ch.-1032241
- 4) Disc wheels, ch.1032242-
- 5) Spoke wheels
- 6) Disc wheels, ch.-1097602 SSS, ch.-4246024 SN
- 7) Disc wheels, ch.1097603 SSS-, ch.4246025 SN-
- 8) Spoke wheels, ch.-1105665 SSS, ch.-4238514 SN
- 9) Spoke wheels, ch.1105666 SSS-, ch.4238515 SN-
- 10) Disc wheels
- 11) Spoke wheels, chassis width 2300 mm
- 12) Spoke wheels 20" or 22.5" hub, ch.-1103187 SSS, ch.-4248317 SN
- 13) Spoke wheels 20" or 22.5" hub, ch.1103188 SSS-, ch.4248318 SN
- 14) Spoke wheels, 24" hub
- 15) Ch.-1097602 SSS, ch.-4246024 SN
- 16) Ch.1097603 SSS-, ch.4246025 SN-
- 17) Disc wheels, ch.-1033747
- 18) Disc wheels, ch.1033748-
- 19) Spoke wheels 20" or 22" hub, ch.-1103187 SSS, ch.-4248317 SN



Remarks

- 20) Spoke wheels, 20" or 22" hub, ch.1033188 SSS-, ch.4248318 SN-
- 21) Disc wheels, spoke wheels
- 22) Disc wheels, (4x2, 6x2, 6x4)
- 23) Spoke wheels, (4x2, 6x2, 6x4) 20" or 22,5" hub
- 24) Spoke wheels, 24" hub. Brake shoe 178 mm
- 25) Spoke wheels, 24" hub. Brake shoe 203 mm
- 26) Twin steer axle
- 27) Spoke wheels, 20", 22,5" or 24" hub
- 28) Without hub reduction
- 29) With hub reduction
- 30) Disc wheels, ch.-1029858
- 31) Disc wheels, ch.1029859-
- 32) Disc wheels, spoke wheels, 24" hub
- 33) Disc wheels, spoke wheels, 20" or 22,5" hub
- 34) Disc wheels, spoke wheels, 20", 22,5" or 24" hub
- 35) Disc wheels, ch.-1161721 SSS, ch.-4292924 SN
- 36) Disc wheels, ch.1161722 SSS-, ch.4292925 SN-
- 37) Disc wheels, spoke wheels, 24" hub, ch.-1180029 SSS
- 38) Disc wheels, spoke wheels, 24" hub, ch.1180030 SSS-
- 39) Disc wheels, ch.-1850412
- 40) Disc wheels, ch.1850413-
- 41) Leaf springs susp. ch.-1801229
- 42) Leaf springs susp. ch.1801230-
- 43) Air suspension, ch.-1802872
- 44) Air suspension, ch.1802873-
- 45) Ch.-1801229
- 46) Ch.1801230-
- 47) Disc wheels, ABS/Non ABS
- 48) ABS/Non ABS
- 49) Air suspension
- 50) Air suspension. ABS
- 51) Air suspension, trapeze suspension
- 52) Air suspension, trapeze suspension. ABS
- 53) Disc wheel, ch.-1871409
- 54) Ch.1871410-1871595
- 55) Ch.1871596-
- 56) Ch.1871410-
- 57) Brake shoe 5"
- 58) Brake shoes 7". Ch.1801196-
- 59) Ch.-1801195
- 60) Ch.1801196-
- 61) Ch.-1808231
- 62) Ch.1808232-
- 63) ABS/Non ABS. Ch.-1808901, Ch.1808902
- 64) ABS/Non ABS. Ch.-1806768, Ch.1806769-
- 65) Hub for trailing axle
- 66) Disc wheel, ABS/Non. Ch.-1808901, Ch.1808902-
- 67) Air suspension. 22.5" hub
- 68) Air suspension. 22.5" hub. ABS
- 69) ABS
- 70) Hub 8.25 x 22.5"
- 71) Hub 8.25 x 22.5". ABS
- 72) Hub 9.00 x 22.5"
- 73) Hub 9.00 x 22.5". ABS
- 74) 6.5 tons
- 75) 6.5 tons. ABS
- 76) 7.1 tons

- 77) 7.1 tons. ABS
- 78) 6.5 tons. Ch.-1820117, Ch.1820118-
- 79) 6.5 tons. Ch.-1820117. ABS
- 80) 7.1 tons. Ch.-1820117
- 81) 7.1 tons. Ch.-1820117. ABS
- 82) ABS/Non ABS. Ch.-1820117, Ch.1820118-
- 83) Air suspension, ch.-1801229
- 84) Air suspension, ch.1801230-1802872
- 85) Disc wheels, Non ABS, Ch.9015825 SAN-, Ch.4362206 SNL-, Ch.1226892 SSS-
- 86) Disc wheels, ABS, Ch.9015825 SAN-, Ch.4362207 SNL-, Ch.1226892 SSS-
- 87) Spoke wheels, ABS/Non ABS
- 88) Disc wheels, ABS/Non ABS, Ch.9015825 SAN-, Ch.4362207 SNL-, Ch.1226892 SSS-
- 89) Disc wheels, Non ABS, Ch.9015825 SAN-, Ch.4362207 SNL-, Ch.1226207 SSS-
- 90) Disc wheels, Non ABS
- 91) Disc wheels, Non ABS, RP/RBP 730
- 92) Non ABS, RP/RBP 832
- 93) Disc wheels, ABS
- 94) Disc wheels/Spoke wheels, ABS/Non ABS, Ch.9015825 SAN-, Ch.4362207 SNL-, Ch.1226892 SSS-
- 95) Spoke wheels, Non ABS
- 96) Disc wheels, Ch.1820118-, ABS
- 97) Disc wheels, Ch.1820118-, Non ABS
- 98) To Ch.nr: Scania Sodertalje 1242205, Scania Zwolle 4397541, Scania Angers 9034654, Scania Katrineholm 1833391
- 99) Disc wheels, Disc brake, ABS
- 100) Spoke wheels 22", 22,5" hub
- 101) RP/RBP 832
- 102) 22", 22,5", 24" hub
- 103) 20", 22,5" hub, RBP/RP730
- 104) 24" hub, RP/RBP 832
- 105) Disc wheels Ch.-9015824 SAN, Ch.-4365570 SNL, Ch.-1226891 SSS
- 106) Disc wheels, ABS, Ch.-9015824 SAN, Ch.-4362206 SNL, Ch.-1226891 SSS
- 107) Disc wheels, Disc brake, ABS/Non ABS

SMB

- 1) 107, 6 mm axle, with brakes C1/C2
- 2) 110 mm axle, with brakes D1/K1/H1
- 3) 110 mm axle, with brakes C1/C2/L1/L2 (100 teeth)
- 4) 110 mm axle, with brakes C3/C5, (80 teeth)

TRAILOR

- 1) 107, 6 mm axle, with brakes C1/C2
- 2) 110 mm axle, with brakes D1/K1/H1
- 3) 110 mm axle, with brakes C1/C2/L1/L2 (100 teeth)
- 4) 110 mm axle, with brakes C3/C5, (80 teeth)

VOLKSWAGEN

- 1) 1976-96
- 5) Ch.21N-006786 -, 08/91-96, 22,5 mm locking ring
- 7) Except twin wheel. Ch.28G-015892 - 21N-006785, 04/86-07/91, 20 mm locking ring
- 8) Except twin wheel. Ch.21N-006786 -, 08/91-96, 22,5 mm locking
- 9) Coil springs, 1979-82
- 10) Leaf springs, ch.-28-B-018540, 1979-81
- 11) Leaf springs, ch.28-B-018541-, 1981-82
- 12) 1979-82
- 13) Ch.-28-B-019162, 1979-81
- 14) Ch.28-B-019163-, 1981-82
- 15) 1983-96
- 16) 3500 kg, 1983-96
- 17) 4000 kg, 1983-96
- 18) 1984-96
- 19) 05/96 - 10/04
- 20) 05/96 - 10/04, Mod. LT 28, LT 35
- 21) 05/96 - 10/04, Mod. LT 46
- 22) 08/67 - 07/79
- 23) 08/71 - 12/73
- 24) 08/75 - 07/79
- 25) 08/70 - 07/92
- 26) 08/79 - 12/82
- 27) 08/79 - 12/84, Ch.-24-E-023827
- 28) 01/84 - 07/92, Ch.24-E-023828 -
- 29) 10/86 - 07/92
- 30) 01/84 - 07/92, Ch.24-E-023828 -
- 31) 08/85 - 07/92
- 32) 11/84 - 07/92
- 33) 08/75 - 07/92
- 34) 07/90 - 10/04
- 35) 10/92 - 10/04
- 36) 07/90 - 10/04, 800-1200 Kg
- 37) 10/92 - 10/04, 800-1200 Kg
- 38) 04/03 - 09/04, Ch.-7 H-4-017500, 7J-4-017500
- 39) 07/04 - 09/04, Ch.-7 H-4-017500, 7J-4-017500
- 40) 04/03 - 10/04
- 41) 07/04 - 10/04

VOLVO

- 1) Hub 363067
- 2) 57 mm stub axle
- 3) Ch.-20653
- 4) Disc wheels, ch.20654-
- 5) Spoke wheels, ch.20654-
- 6) Disc wheels, spoke wheels, -1503875
- 7) Spoke wheels, 1503876-
- 8) Without hub reduction, ch.36634-
- 9) With hub reduction
- 10) Without hub reduction
- 11) Disc wheels
- 12) Spoke wheels
- 13) Ch.-6997
- 14) Disc wheels, ch.6998-
- 15) Spoke wheels, ch.6998-
- 16) Stiff springs
- 17) Soft springs

Remarks

- | | | |
|---|---|---|
| 18) Ch.-7050 | 78) Disc wheels, with hub reduction | 135) Oil lubricated, rear steer ABS/Non ABS |
| 19) Ch.7051- | 79) Ch.-52439 | 136) Oil lubricated |
| 20) Ch.-23510 | 80) Ch.52440- | 137) Ch.-3906 |
| 21) Ch.23511- | 81) Disc wheels, ch.306000-, bolt circle diam. 335 mm | 138) Ch.3907- |
| 22) Ch.-2376 | 82) Spoke wheels 20", 24" hub, ch.306000- | 139) Ch.4308-. ABS |
| 23) Ch.2377- | 83) Disc wheels, ch.306000-, ABS/Non ABS, bolt circle diam. 335 | 140) Including front axle load, FAT 5,0 |
| 24) Ch.-6450 | 84) Disc wheels, ch.-46315 | 141) CHID-B169140, disc wheels, bolt circle diam. 335 mm |
| 25) Ch.6451- | 85) Disc wheels, ch.46316-, ABS/Non ABS | 142) Non ABS, disc wheels, bolt circle diam. 335 mm |
| 26) Ch.-703 | 86) Spoke wheels 24" hub, ch.49001- | 143) Hub 6774825. Including front axle load. FAT 4,7 |
| 27) Ch.704- | 87) Disc wheels 20", 22.5", 24" hub | 144) CHID -B170985 |
| 28) Ch.-21671 | 88) Construction vehicle with straight front axle | 145) CHID B170986- |
| 29) Ch.21672- | 89) Spoke wheels 24" hub | 146) S-60677, S-60936 |
| 30) Ch.-3145 (approx.) | 90) Ch.-36763 | 147) Disc wheels, bolt circle diam. 335 mm, with air suspension. |
| 31) Ch.3146 (approx.)-6871 | 91) Ch.36764- | 148) Disc wheels, bolt circle diam. 335 mm, BAT 11,5 with leaf springs suspension |
| 32) Ch.6872- | 92) Ch.-65820 | 149) 6X2 TAG (HENDRICKSON) |
| 33) Ch.-2728 | 93) Ch.-65820, Spoke wheels 20", 24" hub | 150) 6774825, 6795568 |
| 34) Ch.2729-6871 | 94) Disc wheels, without hub reduction | 151) Incl. special model; S-60945, S-60990, S-60993, S-61208, S-61230 |
| 35) ABS/Non ABS | 95) Disc wheels, ch.-22914 | 152) B 6FA, ch.-404. (Repl. 6772232, 6770991, 6771541, 960234, 6772691,95678, 18665. One pcs of each) |
| 36) Semi, rigid axle | 96) Disc wheels, ch.22915- | 153) ABS/Non ABS. Ch.5000- |
| 37) For vehicle with fixed construction | 97) Spoke wheels 20" hub, ch.34001- | 154) Ch.5000- |
| 38) For vehicle without fixed construction | 98) Spoke wheels 24" hub, ch.34001- | 155) CHID.-A276505, -B190367, -563621 |
| 39) Disc wheels, bolt circle diam. 335 mm | 99) With air suspension | 156) BAT 10,0 BAT 10,9 BAT 11,2 |
| 40) ABS/Non ABS. Disc wheels, bolt circle diam. 335 mm | 100) Special model, super volyme S-10609, S-10610, S-10801, S-11010, S-97024, S-97025, ch.314000- | 157) BAT 11,5 BLF-B BAT 13,0 |
| 41) Disc wheels, ch.-27087 | 101) Spoke wheels, 20", 24" hub | 158) BAT 11,5 LUF-B |
| 42) Disc wheels, ch.27088- | 102) Spoke wheels, with single reduction | 159) Including front axle load FAT 4,7 |
| 43) Spoke wheels 20" hub, ch.-27087 | 103) Tandem axle with hub reduction | 160) WTT-D275 |
| 44) Spoke wheels 22" hub, ch.-27087 | 104) Single mounted trailing wheel, disc wheels | 161) Ch.-A286102, -B207062, D120498 |
| 45) Spoke wheels, ch.27088- | 105) Double mounted trailing wheels, disc wheels | |
| 46) Spoke wheels 20" hub | 106) Ch.-15169 | |
| 47) Spoke wheels, without hub reduction | 107) Ch.15170- | |
| 48) Disc wheels, ch.-19745 | 108) Disc wheels, ch.-8779 | |
| 49) Disc wheels, ch.19746- | 109) Disc wheels, ch.8780- | |
| 50) With air suspension and special design | 110) Spoke wheels, ch.-12000 | |
| 51) With S-ride and single wheels | 111) Spoke wheels 20" hub, ch.12001- | |
| 52) Disc wheels, earlier models | 112) Spoke wheels 24" hub, ch.12001- | |
| 53) Spoke wheels, earlier models | 113) Spoke wheels 22", 22.5", 24" hub | |
| 54) Construction vehicle with straight front axle and heigh tened belly clearance | 114) Spoke wheels 20" hub, with leaf springs suspension, ABS/Non ABS | |
| 55) Spoke wheels, ABS/Non ABS | 115) Spoke wheels 24" hub, with leaf springs suspension | |
| 56) Disc wheels, ABS/Non ABS | 116) Spoke wheels 20" hub, with air suspension | |
| 57) Disc wheels, BGT 18/21/26 with leaf springs susp. rear | 117) Spoke wheels, ch.314000-, with air suspension, rear | |
| 58) Disc wheels, air susp. S-ride, rear steer | 118) Special model, super volume; 1) S-10099, S-10365, S-10803, S-11011 2) S-10111, S-10112, S-97024, S-97025 | |
| 59) With air suspension and rear steer | 119) Ch.7980 | |
| 60) ABS/Non ABS, with leaf springs susp. | 120) Ch.7981- | |
| 61) Ch.-12099 | 121) Ch.-3404 | |
| 62) Ch.12100- | 122) Ch.3405-7980 | |
| 63) Ch.12001- | 123) Ch.-5256 | |
| 64) Disc wheels, ch.-11549 | 124) Ch.5257- | |
| 65) Disc wheels, ch.11550- | 125) B 6F | |
| 66) Ch.-26821 | 126) B 6FA | |
| 67) Ch.26822- | 127) Ch.865-. Except Ch.873-875, oil lubricated | |
| 68) Disc wheels, ch.-40640, ABS/Non ABS | 128) B 6F, B 609, B 610 | |
| 69) Spoke wheels 20" hub, without hub reduction | 129) B 6FA, ch.-404, hub 6772232 | |
| 70) Spoke wheels 24" hub, without hub reduction | 130) B 6FA, ch.405- | |
| 71) Disc wheels, ch.-20876, ABS/Non ABS | 131) Ch.20000- | |
| 72) Disc wheels, ch.20877-, ABS/Non ABS | 132) Ch.-10521. Grease lubricated | |
| 73) Disc wheels, ch.25001-40640, bolt circle diam. 335 mm | 133) Ch.10522-. Oil lubricated | |
| 74) Spoke wheels 20" hub, ch.25001-40640 | 134) Grease lubricated, rear steer | |
| 75) Spoke wheels 24" hub, ch.25001-40640 | | |
| 76) With air suspension, ch.-25000 | | |
| 77) S-ride, rear steer, ch.25001-40640 | | |



Hinweise zur Benutzung des Kataloges

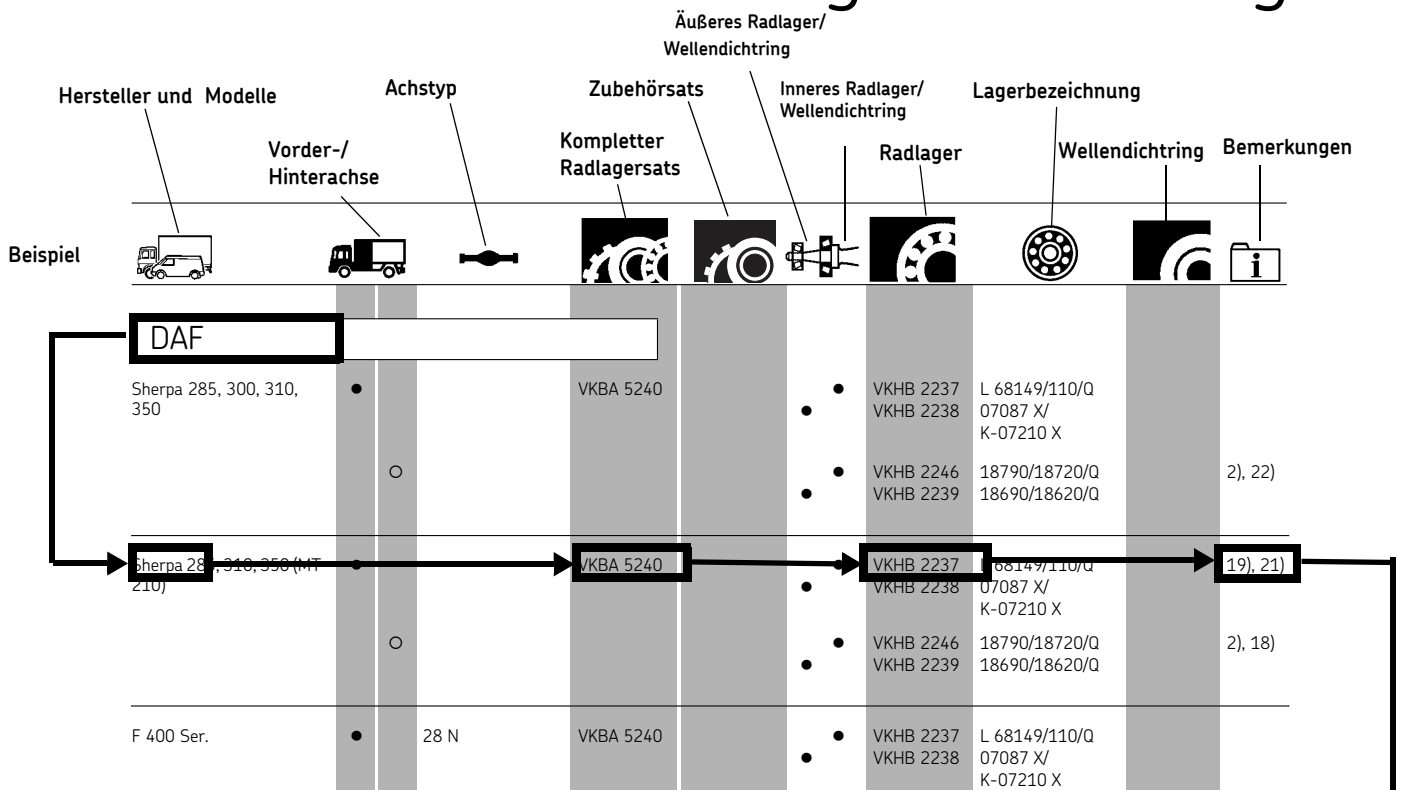













Inhalt der Sätze

	A	B	C	D	E	F	G	H	I	J	K	L			
VKA 4004							1		1				VOLVO	●	○
VKA 4026							1		1				VOLVO		○
VKA 4036							2	1					SCANIA		○
VKA 4038							1	1					SCANIA		○
VKA 4094							2	1					MERCEDES-BENZ	●	○
VKA 4095							1	2					MERCEDES-BENZ	●	○

A	B	C	D	E	F	G	H	I	J	K	L
Lager	Sicherungsbleck	Mutter	Distanzring	Haltering	Sicherungsring	Wellendichtring	Dichtung	O-ring	Verschleißring	Splint	Zubehör



VKBA = VKHB + VKHB + VKA/VKS

						
						
VKBA 5025 VKBA 5026	VKHB 2056 VKHB 2059	VKHB 2057 VKHB 2007	VKS 6299			

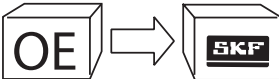
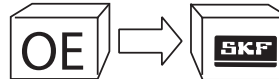
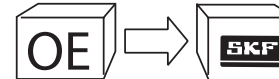

Vergleichsliste OE - SKF

		
BPW		FIAT / IVECO
02.5664.26.57 02.5664.46.57 02.5664.55.57	0174592 0174595 0190069 0221664 0266487	1101597 1102042
VKS 6285 VKS 6287 VKS 6250 VKS 6251	VKHB 2043 VKHB 2141 VKS 6171 VKHB 2222 VKHB 2223	VKHB 2060 VKHB 2282 VKHB 2283





Vergleichsliste SKF - OE

	
VKBA 519	VKBA 3616
VW VW FORD FORD MERCEDES BENZ	RENAULT / RVI OPEL OPEL OPEL
211 498 071 211 498 071 BS 5 007 029 5 007 028 116 220 00 54	77 01 206 742 44 08 669 91160087 77 01 206 848 116 220 00 54

Lager - SKF VKHB

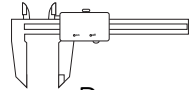
		
07087 X/K-07210 X 10B 2010	VKHB 2238 VKHB 2268 VKHB 2269	32310 TN9 32311 I2
	VKHB 2303 VKHB 2304	10500/29520/Q VKHB 2175 VKHB 2176

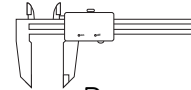
Suche nach Abmessungen (Dichtung)

					
d	D	W	d	D	W
44,0 53,0	85,0 97,0	10,0/8,0 8,0 12,0	117,4 119,0	142,8	12,7 27,0
		VKS 6229 VKS 6219			VKS 6108 VKS 6109

DEUTSCH



Symbole

Symbole im Katalog



Neuaufnahmen



Anwendung, LKW



Anwendung, Bus



Anwendung,
Anhänger-/Sattelauffleigerachsen



Inhalt der Sätze



VKBA=VKHB+VKHB+VKA/VKS



Vergleichliste OE - SKF



Vergleichliste SKF - OE



Lager - SKF VKHB



Suche nach Abmessungen (Dichtung)

Allgemeine Symbole



Bis



Von



Ersetzungen



Nicht mer im Sortiment



Werkzeuge

Abkürzungen

Ch.	Fahrgestellnummern
Forward rear axle	Erste Hinterachse
Rear rear axle	Zweite Hinterachse
Trailing axle	Nachläuferachsen

VKBA XXXX	In Produktion
VKHB XXXX	In Produktion
VKA XXXX	In Produktion
VKS XXXX	In Produktion
VKN XXX	In Produktion

Bemerkungen

BPW

- 1) Tieflader
- 2) Ohne Tieflader

CITROËN

- 1) 09/81 - 12/89, Ch.-604496
- 2) 01/89 - 03/04, Ch.604497 -
- 3) 02/91 - 03/94
- 4) 01/87 - 12/89, Ch.-604496
- 5) 01/89 - 02/94, Ch. 604497 -
- 6) 09/81 - 12/86, Linkes Rad, Ch.-289710, Nutzlast : 1000, 1300 Kg
- 7) 09/81 - 12/86, Rechtes Rad, Ch.-289710, Nutzlast: 1000, 1300 Kg
- 8) 09/81 - 03/94, Linkes Rad, Nutzlast:1800 Kg
- 9) 09/81 - 03/94, Rechtes Rad, Nutzlast: 1800 Kg
- 10) 01/86 - 03/94, Linkes Rad, Ch.289711-, Nutzlast: 1000, 1300, 1400 Kg
- 11) 01/86 - 03/94, Rechtes Rad, Ch.289711-, Nutzlast: 1000, 1300, 1400 Kg
- 12) 01/87 - 02/94,
- 13) 02/94 - 04/02, Ch.-16194399, Nutzlast:1000, 1400 Kg
- 14) 02/94 - 04/02, Ch.-16194399, Nutzlast: 1800 Kg
- 15) 02/94 - 04/02, Ch.16194400 -, Nutzlast: 1000, 1400 Kg
- 16) 02/94 - 04/02, Ch.16194400 -, Nutzlast: 1800 Kg
- 17) 04/02 - 09/04, Nutzlast: 1000, 1400 Kg
- 18) 04/02 - 09/04, Nutzlast: 1800 Kg
- 19) 03/94 - 04/02, Ch.-16194399, Nutzlast: 1000, 1400 Kg
- 20) 03/94 - 04/02, Ch.-16194399, Nutzlast: 1800 Kg
- 21) 03/94 - 04/02, Ch.16194400 -, Nutzlast: 1000, 1400
- 22) 03/94 - 04/02, Ch.16194400 -, Nutzlast: 1800 Kg
- 23) 08/96 - 04/02, Ch.-16194399, Nutzlast: 1000, 1400
- 24) 08/96 - 04/02, Ch.-16194399, Nutzlast: 1800 Kg
- 25) 08/96 - 04/02, Ch.16194400 -, Nutzlast: 1000, 1400 Kg
- 26) 08/96 - 04/02, Ch.16194400 -, Nutzlast: 1800 Kg
- 27) 02/94 - 04/02, Ch.16194400 -
- 28) Trommelbremsen
- 29) Scheibenbremsen

DAF

- 2) Doppelrad hinten
- 3) Spurweite 1718 mm. Nabe mit 10 Bolzen
- 4) Spurweite 1655 mm. Nabe mit 8 Bolzen
- 5) Ohne Nabenzentrierung
- 6) Mit Nabenzentrierung
- 7) Mit Nabenzentrierung. Dichtung schwarz
- 8) Mit Nabenzentrierung. Dichtung blau

- 9) Mit Radnabenvorgelege
- 10) Ohne FAR
- 11) Mit FAR
- 12) Ohne FA, FT
- 13) Mit FA, FT
- 14) Ohne Nabenzentrierung. Dichtung schwarz
- 15) Ohne Nabenzentrierung. Dichtung blau
- 16) Dichtung schwarz
- 17) Dichtung blau
- 18) 1983-85
- 19) Ch. 237886-, ohne Zwillingrad
- 21) 1984-85
- 22) 1985-12/89
- 23) -12/89
- 24) Dichtung/ABS, separat

FIAT-IVECO

- 4) Linkes Rad
- 5) Rechtes Rad
- 8) Linkes Rad, 06/79-06/81
- 9) Rechtes Rad, 06/79-06/81
- 10) 10/77 - 06/81
- 11) Linkes Rad, 06/81 - 09/84
- 12) Rechtes Rad, 06/81 - 09/84
- 13) 06/81 - 09/84
- 14) Linkes Rad, 10/84 - 88
- 15) Rechtes Rad, 10/84 - 88
- 16) 10/84 - 88
- 17) 03/85 - 88
- 18) Ch.-604496, 1982-89
- 19) Ch.604497-, 1989-93
- 20) Linkes Rad, ch.-278757, 1982 - 86
- 21) Rechtes Rad, ch. -278757, 1982 - 86
- 22) Linkes Rad, ch.278758 -, 1986 - 93
- 23) Rechtes Rad, ch.278758 -, 1986 - 93
- 24) 1982 - 86
- 25) Ch.-604496, 1986 - 89
- 26) Linkes Rad, 1986 - 93
- 27) Rechtes Rad, 1986 - 93
- 28) 10/77 - 12/86
- 29) 01/87-
- 30) Ohne 50-9D, 50-9V
- 31) 04/91 - 04/92
- 32) 01/85-
- 33) Scheibenbremsen
- 34) 12/85-
- 36) 1991 - 94
- 37) Linkes Rad, 1991 - 94
- 38) Rechtes Rad, 1991 - 94
- 39) Ohne ABS
- 40) Ohne Modelle für die Schweiz
- 41) Modelle für die Schweiz
- 42) Verhältnis 4.23/1
- 43) Ohne Verhältnis 4.23/1
- 44) Verhältnis 4.23/1. Ohne Modelle für die Schweiz
- 45) Ohne Verhältnis 4.23/1. Ohne Modelle für die Schweiz
- 46) Ohne Verhältnis 3.79/1
- 47) Verhältnis 3.79/1
- 48) Ch.-173788
- 49) Ch.173789-. Achse -1824487
- 50) Ch.173789-. Achse 1824488-
- 51) Ch.173789-

- 52) Bohrungsdurchmesser des Innenlagers 95 mm
- 53) Bohrungsdurchmesser des Innenlagers 105 mm. Achse -1824487
- 54) Bohrungsdurchmesser des Innenlagers 105 mm. Achse 1824488-
- 55) Lenkachse.Steife Achse, Ersatzteil 7177196
- 56) Steife Achse, Ersatzteil 7177168
- 57) Bohrungsdurchmesser des Innenlagers 100 mm
- 58) Achse -1824487
- 59) Achse 1824488-
- 60) Linkes Rad, 06/79 - 01/97
- 61) Rechtes Rad ,06/79 - 01/97
- 62) 06/81 - 01/97
- 63) Linkes Rad, 06/81 - 88
- 64) Rechtes Rad, 06/81 - 88
- 65) Ohne Verhältnis 5.22/1. -02/96
- 66) Verhältnis 5.22/1. -02/96
- 67) Linkes Rad, 06/79 - 02/96
- 68) Rechtes Rad, 06/79 - 02/96
- 69) 10/77 - 09/84
- 70) Ohne "Iveco check control"
- 71) "Iveco check control"
- 72) Linkes Rad, -02/96
- 73) Rechtes Rad, 02/96
- 74) -02/96
- 75) Verhältnis 5.62/1
- 76) Ohne Verhältnis 5.62/1
- 77) ABS
- 78) Linkes Rad, 03/85 - 88
- 79) Rechtes Rad, 03/85 - 88
- 81) -02/96
- 82) 03/96-
- 83) 1994-
- 84) 1996-
- 85) Einreihiges Kegelrollenlager
- 86) Zweireihiges Kegelrollenlager
- 87) Steife Achse
- 88) Lenkachse
- 89) Vorderradantrieb
- 90) Hinterradantrieb
- 91) Linkes Vorderrad, mit einreihiges Kegelrollenlager, 03/96 - 12/99
- 92) Rechtes Vorderrad, mit einreihiges Kegelrollenlager, 03/96 - 12/99
- 93) Zweireihiges Kegelrollenlager, 03/96 - 12/99
- 94) Bis 05/89
- 95) 06/89 - 01/97
- 96) 01/96 - 12/99
- 97) Bis 12/99
- 98) 05/99 - 08/03
- 99) 06/81 - 01/97
- 100) 04/02 - 01/04
- 101) 07/02 - 01/04
- 102) Nutzlast 1100, 1500 Kg
- 103) Nutzlast 1800 Kg

FORD

- 1) 1965-91
- 2) 07/74-12/77
- 3) 08/65-12/77
- 6) 11/73-12/77

Bemerkungen

- 7) 01/78-10/85
- 8) Linkes Rad, 11/85-91
- 9) Rechtes Rad, 11/85-91
- 10) 11/85-91
- 11) 1992-97
- 12) 01/81-03/87
- 13) 03/87-12/92
- 14) 04/82 - 09/87
- 15) 10/87 - 12/90 Linkes Rad
- 16) 10/87 - 12/90 Rechtes Rad
- 18) 01/00 - 10/04
- 19) 01/00 - 10/04, Non ABS, Nutzlast 1000 Kg, Vorderradantrieb
- 20) 01/00 - 10/04, ABS, Nutzlast 1000 Kg, Vorderradantrieb
- 21) 07/03 - 10/04, Ohne ABS, Nutzlast 2000 Kg, Vorderradantrieb
- 22) 07/03 - 10/04, ABS, Nutzlast 2000 Kg, Vorderradantrieb
- 23) 01/00 - 10/04, Einzelrad, Hinterradantrieb
- 24) 01/00 - 10/04, Zwillingräder, Hinterradantrieb
- 25) 03/04 - 10/04, Ohne ABS, Nutzlast 2000 Kg
- 26) 03/04 - 10/04, ABS, Nutzlast 2000 Kg

GIGANT (SAE)

- 1) Air suspension Type N
- 2) Achse Protec

FRUEHAUF

- 1) Achse 107, 6 mm, Bremsen C1/C2
- 2) Achse 110 mm, Bremsen D1/K1/H1
- 3) Achse 110 mm, Bremsen C1/C2/L1/L2 (100 Zähne)
- 4) Achse 110 mm, Bremsen C3/C5, (80 Zähne)

MAN

- 1) -11/93
- 2) 12/93-
- 3) W25/86-W27/90
- 4) W28/90-
- 5) Ohne ABS
- 6) ABS
- 7) 01/90-
- 8) Hub. 81.35701.0081
- 9) Hub. 81.35701.0127
- 10) 20" TRILEX
- 11) Hub. 81.35701.0141
- 12) Ohne "TRILEX"
- 13) "TRILEX"
- 14) -W18/94
- 15) W19/94-
- 16) -W27/96
- 17) W28/96-, Nabe 19.5"
- 18) W28/96-, Nabe 20/22.5"

MERCEDES-BENZ

- 1) 02/88 - 02/96
- 2) 02/88 - 02/96, Ch.-128165
- 3) 1983-90
- 4) Ch.-48630
- 5) Ch.48631-
- 6) Dieselmotor ch. -17768, Benzinmotor ch. -1288
- 7) Dieselmotor ch. 17768-78114, Benzinmotor ch. 1289-4706
- 8) Dieselmotor ch. 78115-, Benzinmotor ch. 4707-
- 9) Bohrungsdurchmesser des Innenlagers 55 mm
- 10) Achse -1358880
- 11) Achse 1358881-
- 12) 02/88 - 02/96, Ch.128166-
- 13) Achse -1278813
- 14) Achse 1278814-
- 15) 02/88 - 05/92, pickup
- 16) 02/73 - 12/77
- 17) 01/95 - 05/02, bis Achse: S213915/Y245976
- 18) 01/95 - 05/02
- 19) Achse -1390839
- 20) Achse 1390840-
- 21) Achse -1278313
- 22) Achse 1278314-
- 23) 02/95 - 07/04, bis Achse: S231915/Y245976
- 24) Trommelbremsen
- 25) ABS, Achse -021298
- 26) ABS, Achse 021299-
- 27) Achse -724723
- 28) Achse 724724-
- 29) Hub 3553564401
- 30) Hub 3463563001
- 31) 02/95 - 07/04
- 32) 02/96 - 05/02, bis Achse: S231915/Y245976
- 33) 02/96 - 05/02
- 34) 09/96 - 07/04
- 35) 02/96 - 07/04
- 37) Nabe: 668 356 01 01, 668 356 02 01
- 38) Nabe: 972 356 01 01
- 39) Nabe: 976 356 11 01
- 40) Nabe: 678 356 04 01
- 41) Nabe: 675 356 01 01
- 42) Scheibenbremsen
- 43) Nabe: 942 334 08 01
- 44) Nabe: 942 334 07 01, 949 334 05 01

MERITOR (ROR)

- 1) Fettgeschmiert

MONTENEGRO

- 1) Achse: 061001243, 061001243 A
- 2) Achse: 06-1-1068
- 3) Achse: 06-1-1176, 061001231
- 4) Achse: 061001271

- 5) Achse: 061001231 A
- 6) Achse: 061001230, 061001230 A
- 7) Achse: 06-1-1025
- 8) Achse: 061001170 A
- 9) Achse: 061001299
- 10) Achse: 061001210, 061001210 B, 061001295
- 11) Achse: 06-1-1103, 06-1-1170
- 12) Achse: 06-1-1100, 06-1-1102, 06-1-1106, 06-1-1108, 06-1-1173, 06-1-1174

OPEL

- 1) 09/00 - 10/01, Rad 15", Ch.-B 000010, Motor Code:F9Q-770
- 2) 09/00 - 10/01, Rad15", Ch. B 000011-, Motor Code: F9Q-770
- 3) 07/98 - 10/01, Rad 16"
- 4) 07/98 - 10/01, Pickup, Rad 15", Ch.-B 0000514, B 006055, Motor Code: S8U-702
- 5) 07/98 - 10/01, Kasten, Bus, Dumpertruck, Rad 15", Ch.-B 051615, Motor Code: S9W-702
- 6) 07/98 - 10/01, Pickup, Rad 15", Ch.B 0000515-, B 006056-, Motor Code: S8U-702
- 7) 07/98 - 10/01, Kasten, Bus, Dumpertruck, Rad 15", Ch.B 051616-, Motor Code:S9W-702
- 8) 07/98 - 10/01, Rad 15"
- 9) 07/98 - 10/01, Rad 16"
- 10) 08/01 - 08/05, Ohne ABS, Ch.- 3V613233
- 11) 08/01 - 08/05, ABS, Ch.- 3V613233
- 13) 08/01 - 08/05

PEUGEOT

- 1) 01/83 - 11/88
- 2) 10/90 - 01/01
- 3) 09/81 - 12/89, Ch.-604496
- 4) 01/89 - 09/90, Ch.604497-
- 5) 09/81 - 12/85, Linkes Rad, Nutzlast 1000 Kg, 1300 Kg, Ch.-244300
- 6) 09/81 - 01/01, Linkes Rad, Nutzlast 1400 Kg
- 7) 09/81 - 01/01, Linkes Rad, Nutzlast 1800 Kg
- 8) 09/81 - 01/01, Rechtes Rad, Nutzlast 1400 Kg
- 9) 09/81 - 01/01, Rechtes Rad, Nutzlast 1800 Kg
- 10) 01/86 - 11/88, Linkes Rad, Nutzlast 1000 Kg, 1300 Kg, Ch. 244301-
- 11) 09/81 - 12/85, Rechtes Rad, Nutzlast 1000 Kg, 1300 Kg, Ch.-244300
- 12) 01/86 - 11/88, Rechtes Rad, Nutzlast 1000 Kg, 1300 Kg, Ch.244301-
- 13) 10/90 - 01/01, Linkes Rad, Nutzlast 1000 Kg, 1300 Kg
- 14) 10/90 - 01/01, Rechtes Rad, Nutzlast 1000 Kg, 1300 Kg
- 15) 1967-09/70
- 16) 10/70-80

Bemerkungen

- | | | |
|---|---|--|
| 17) 1967-80 | 47) 09/93- | 115) 03/80 - 02/89 |
| 18) 1980-88 | 48) Ohne ABS. -08/91 | 116) 01/84 - 12/85, Kasten, Bus |
| 19) 03/94 - 04/02, Nutzlast 1000 Kg, 1400 Kg, Ch.-16194399 | 49) ABS. -08/91 | 117) 01/86 - 02/89, Kasten, Bus |
| 20) 03/94 - 04/02, Nutzlast 1800 Kg, Ch.-16194399 | 50) 09/91-03/93 | 118) 03/89 - 04/89 |
| 21) 03/94 - 04/02, Nutzlast 1000 Kg, 1400 Kg, Ch.16194400- | 51) 09/91- | 119) 05/89 - 01/01, Kasten, Bus |
| 22) 03/94 - 04/02, Nutzlast 1800 Kg, Ch.16194400- | 52) -03/93 | 120) 05/89 - 01/01 |
| 23) 04/02 - 07/04, Nutzlast 1000 Kg, 1400 Kg | 53) -08/91 | 121) 05/89 - 01/01, Pickup, Model type:PC |
| 24) 04/02 - 07/04, Nutzlast 1800 Kg | 54) -07/90 | 122) 05/89 - 01/01, Kasten, Bus, innerer Lager 35x72x24.5 mm |
| 25) 07/96 - 04/02, Nutzlast 1000 Kg, 1400 Kg, Ch.-16194399 | 55) 08/90- | 123) 05/89 - 01/01, Kasten, Bus, innerer Lager 35x62x18.3 mm |
| 26) 07/96 - 04/02, Nutzlast 1800 Kg, Ch.-16194399 | 56) -02/91 | 124) 03/01 - 11/02, ohne ABS |
| 27) 07/96 - 04/02, Nutzlast 1000 Kg, 1400 Kg, Ch.16194400- | 57) 03/91- | 125) 03/01 - 11/02, mit ABS |
| 28) 07/96 - 04/02, Nutzlast 1800 Kg, Ch.16194400- | 58) -09/90 | 126) 11/02 - 02/04 |
| 29) 03/04 - 04/02, Ch.16194400- | 59) -02/92 | 127) 03/01 - 02/04 |
| 30) 04/02 - 07/04 | 60) 03/92- | 128) 08/80 - 07/98, Kasten, Bus |
| 31) 10/01 - 04/02 | 61) -05/95 | 129) 09/80 - 07/98, Pickup |
| 32) 11/00 - 09/01, Nutzlast 1000 Kg, 1400 Kg | 62) 06/95- | 130) 07/98 - 03/00 |
| 33) 11/00 - 09/01, Nutzlast 1800 Kg | 63) Trommelbremsen | 131) 03/00 - 02/04 |
| 34) 07/96 - 04/02, Trommelbremsen | 64) Scheibenbremsen | 132) 07/98 - 01/01 |
| 35) 07/96 - 04/02, Scheibenbremsen | 65) -02/85 | 133) 07/98 - 10/01, Kasten, Bus |
| 36) 01/86 - 01/01, Linkes Rad, Nutzlast 1000 Kg, 1300 Kg, Ch.244301- | 66) 03/85- | 134) 07/98 - 10/01, Kasten, Pickup |
| 37) 01/86 - 01/01, Rechtes Rad, Nutzlast 1000 Kg, 1300 Kg, Ch.244301- | 67) -17/11/93 | 135) 09/00 - 02/04, Kasten, Trommelbremsen |
| | 68) 18/11/93- | 136) 09/00 - 02/04, Kasten, Scheibenbremsen |
| | 69) 10/87- | 137) 09/00 - 02/04, Bus, Trommelbremsen |
| | 70) ABS | 138) 09/00 - 02/04, Bus, Scheibenbremsen |
| | 71) -12/92 | 139) 09/00 - 02/04, Pickup, Trommelbremsen |
| | 72) 01/93- | 140) 09/00 - 02/04, Pickup, Scheibenbremsen |
| | 73) 01/77-14/03/84 | 141) 07/98 - 01/01, Kasten, Trommelbremsen |
| | 74) 03/86- | 142) 07/98 - 01/01, Kasten, Scheibenbremsen |
| | 75) Ohne ABS. -08/91 Ohne "Trilex" | 143) 10/01 - 02/04, Kasten, Trommelbremsen |
| | 76) ABS. -08/91. Ohne "Trilex" | 144) 10/01 - 02/04, Kasten, Scheibenbremsen |
| | 77) "Trilex" 20".-03/93. | 145) 07/98 - 01/01, Bus, Trommelbremsen |
| | 78) "Trilex" 24".-03/93. | 146) 07/98 - 01/01, Bus, Scheibenbremsen |
| | 79) 09/91-03/93. Ohne "Trilex" | 147) 10/01 - 02/04, Bus, Trommelbremsen |
| | 80) -02/86 | 148) 10/01 - 02/04, Bus, Scheibenbremsen |
| | 81) -12/87 | 149) 07/98 - 01/01, Pickup, Trommelbremsen |
| | 82) Mutter M75. -05/91 | 150) 07/98 - 01/01, Pickup, Scheibenbremsen |
| | 83) Mutter M70. -05/91 | 151) 10/01 - 02/04, Pickup, Trommelbremsen |
| | 84) Ohne-ABS | 152) 10/01 - 02/04, Pickup, Scheibenbremsen |
| | 85) ABS | 153) 07/98 - 10/01, Kasten, Trommelbremsen |
| | 86) -05/95 | 154) 07/98 - 10/01, Kasten, Scheibenbremsen |
| | 87) 06/95- | 155) 07/98 - 10/01, Pickup, Trommelbremsen |
| | 88) -03/89 | 156) 07/98 - 10/01, Pickup, Scheibenbremsen |
| | 89) 04/89- | 157) 10/03 - 02/04, Kasten, Trommelbremsen |
| | 90) 1973-1989 | 158) 10/03 - 02/04, Kasten, Scheibenbremsen |
| | 91) Ohne motor G9T | 159) 10/03 - 02/04, Bus, Trommelbremsen |
| | 92) Fur motor G9T | 160) 10/03 - 02/04, Bus, Scheibenbremsen |
| | 96) 03/89 - 04/89, Kasten, Bus, innerer Lager 35x72x24.5 mm | 161) 10/03 - 02/04, Pickup, Trommelbremsen |
| | 97) 03/89 - 04/89, Kasten, Bus, innerer Lager 35x62x18.3 mm | 162) 10/03 - 02/04, Pickup, Scheibenbremsen |
| | 98) 05/89 - 10/97, Pickup | |
| | 100) 03/80 - 04/89, Kasten, Bus | |
| | 101) 03/80 - 04/89, Pickup | |
| | 102) 18/08/98 - | |
| | 103) - 31/03/98 | |
| | 104) 01/04/98 - | |
| | 105) - 27/08/98 | |
| | 106) - 24/08/98 | |
| | 107) - 17/08/98 | |
| | 108) Einzelrad | |
| | 109) Zwillingräder | |
| | 110) 01/09/91 - 31/03/93 | |
| | 111) - 11/04/2000 | |
| | 112) 12/04/2000 - | |
| | 113) 03/80 - 04/89 | |
| | 114) 03/80 - 12/83, Kasten, Bus | |

RVI

- 12) -14/06/85
- 13) 17/06/85-
- 14) -12/82
- 15) 01/83-
- 16) -15/11/85
- 17) 18/11/85-
- 18) -1986
- 19) 1987-
- 22) 07/86-
- 23) -14/03/84
- 24) 15/03/84-
- 25) 10/84-01/86
- 26) 02/86-
- 27) -09/84
- 28) -01/86
- 29) 10/84-
- 30) -09/83
- 31) 10/83-
- 33) -08/79
- 34) 09/79-
- 35) -08/84 MOT 62030
- 36) -12/83
- 37) 01/84-
- 38) -12/85
- 39) 01/86-
- 40) 12/92-
- 41) -05/91
- 42) 06/91-03/93
- 43) 04/93-
- 44) -08/84 MOT 62030. -N 1539
- 45) -08/84 MOT 62030. N 1540-

SCANIA

- 1) Ch.-1032241
- 2) Ch.1032242-
- 3) Volle Räder, ch.-1032241
- 4) Volle Räder, ch.1032242-
- 5) Speichenräder
- 6) Volle Räder, ch.-1097602 SSS, ch.-4246024 SN
- 7) Volle Räder, ch.1097603 SSS-, ch.4246025 SN-
- 8) Speichenräder, ch.-1105665 SSS, ch.-4238514 SN

DEUTSCH



Bemerkungen

- | | |
|--|--|
| 9) Speichenräder, ch.1105666 SSS-, ch.4238515 SN- | 61) Ch.-1808231 |
| 10) Volle Räder | 62) Ch.1808232- |
| 11) Speichenräder, Fahrgestellbreite 2300 mm | 63) ABS/Ohne ABS. Ch.-1808901, Ch.1808902- |
| 12) Speichenräder, Nabe 20" oder 22.5", ch.-1103187 SSS, ch.-4248317 SN | 64) ABS/Ohne ABS. Ch.-1806768, Ch.1806769- |
| 13) Speichenräder, Nabe 20" oder 22.5", ch.1103188 SSS-, ch. 4248318 SN- | 65) Nabe für Nachläuferachse |
| 14) Speichenräder, Nabe 24" | 66) Volle Räder, ABS/Ohne Ch.-1808901, Ch.1808902- |
| 15) Ch.-1097602 SSS, ch.-4246024 SN | 67) Luftgedert. Nabe 22.5" |
| 16) Ch.1097603 SSS-, ch.4246025 SN- | 68) Luftgedert. Nabe 22.5". ABS |
| 17) Volle Räder, ch.-1033747 | 69) ABS |
| 18) Volle Räder, ch.1033748- | 70) Nabe 8.25 x 22.5" |
| 19) Speichenräder, Nabe 20" oder 22", ch.-1103187 SSS, ch. -4248317 SN | 71) Nabe 8.25 x 22.5". ABS |
| 20) Speichenräder, Nabe 20" oder 22", ch.1103188 SSS-, ch.4248818 SN | 72) Nabe 9.00 x 22.5" |
| 21) Volle Räder, Speichenräder | 73) Nabe 9.00 x 22.5". ABS |
| 22) Volle Räder (4x2, 6x2, 6x4) | 74) 6.5 tons |
| 23) Speichenräder (4x2, 6x2, 6x4), Nabe 20" oder 22.5" | 75) 6.5 tons. ABS |
| 24) Speichenräder, Nabe 24". Bremsbacke 178 mm | 76) 7.1 tons |
| 25) Speichenräder, Nabe 24". Bremsbacke 203 mm | 77) 7.1 tons. ABS |
| 26) Doppellenkachse | 78) 6.5 tons. Ch.-1820117, ch.1820118- |
| 27) Speichenräder, Nabe 20", 22.5" oder 24" | 79) 6.5 tons. Ch.-1820117. ABS |
| 28) Ohne Radnabenvorgelege | 80) 7.1 tons. Ch.-1820117 |
| 29) Mit Radnabenvorgelege | 81) 7.1 tons. Ch.-1820117. ABS |
| 30) Volle Räder, ch.-1029858 | 82) ABS/Ohne ABS. Ch.-1820117, ch.1820118- |
| 31) Volle Räder, ch.1029859- | 83) Luftgedert, ch.-1801229 |
| 32) Volle Räder, Speichenräder, Nabe 24" | 84) Luftgedert, ch.1801230-1802872 |
| 33) Volle Räder, Speichenräder, Nabe 20" oder 22.5" | 85) Volle Räder, Ohne ABS, Ch.9015825-SAN, Ch.4362206 SNL--, ch.1226892 SSS- |
| 34) Volle Räder, Speichenräder, Nabe 20", 22.5" oder 24" | 86) Volle Räder, ABS, Ch.9015825 SAN-, Ch.4362207 SNL-, ch.1226892 SSS- |
| 35) Volle Räder, ch.-1161721 SSS, ch.-4292924 SN | 87) Speichenräder, ABS/Ohne ABS |
| 36) Volle Räder, ch.1161722 SSS-, ch.4292925 SN- | 88) Volle Räder, ABS/Ohne ABS, Ch.9015825 SAN-, ch.4362207 SNL-, ch.1226892 SSS- |
| 37) Volle Räder, Speichenräder, Nabe 24" ch.-1180029 SSS | 89) Volle Räder, Ohne ABS, Ch.9015825 SAN-, Ch.4362207 SNL-, ch.1226207 SSS- |
| 38) Volle Räder, Speichenräder, Nabe 24" ch.1180030 SSS- | 90) Volle Räder, Ohne ABS |
| 39) Volle Räder, ch.-1850412 | 91) Volle Räder, Ohne ABS, RP/RBP730 |
| 40) Volle Räder, ch.1850413- | 92) Ohne ABS, RP/RBP832 |
| 41) Blattfedern ch.-1801229 | 93) Volle Räder, ABS |
| 42) Blattfedern ch.1801230- | 94) Volle Räder/Speichenräder, ABS/Ohne ABS, Ch.9015825 SAN-, ch.4362207 SNL-, ch.1226892 SSS- |
| 43) Luftgedert, ch.-1802872 | 95) Speichenräder, Ohne ABS |
| 44) Luftgedert, ch.1802873- | 96) Volle Räder, Ch.1820118-, ABS |
| 45) Ch.-1801229 | 97) Volle Räder, Ch.1820118-, Ohne ABS |
| 46) Ch.1801230- | 98) Bis -ch. Scania Sodertalje 1242205, Scania Zwolle 4397541, Scania Angers 9034654, Scania Katrineholm 1833391 |
| 47) Volle Räder. ABS/Ohne ABS | 99) Volle Räder, Scheibenbremsen, ABS |
| 48) ABS/Ohne ABS | 100) Speichenräder, Nabe 22" oder 22.5" |
| 49) Luftgedert | 101) RP/RBP 832 |
| 50) Luftgedert/ABS | 102) Nabe 22", 22.5", oder 24". |
| 51) Luftgedert. Trapeze | 103) Nabe 20" oder 22.5", RBP/RP 730 |
| 52) Luftgedert. Trapeze. ABS | 104) Nabe 24", RP/RBP 832 |
| 53) Volle Räder, ch.-1871409 | 105) Volle Räder, ch.-9015824 SAN, ch.-4365570 SNL, ch.-1226891 SSS |
| 54) Ch.1871410-1871595 | 106) Volle räder, ABS, ch.-9015824 SAN, ch.-4362206 SNL, ch.-1226891 SSS |
| 55) Ch.1871596- | 107) Volle räder, Scheibenbremsen, ABS/Ohne-ABS |
| 56) Ch.1871410- | |
| 57) Bremsbacke 5" | |
| 58) Bremsbacke 7". Ch.1801196- | |
| 59) Ch.-1801195 | |
| 60) Ch.1801196- | |

SMB

- 1) Achse 107, 6 mm, Bremsen C1/C2
- 2) Achse 110 mm, Bremsen D1/K1/H1
- 3) Achse 110 mm, Bremsen C1/C2/L1/L2, (100 Zähne)
- 4) Achse 110 mm, Bremsen C3/C5, (80 Zähne)

TRAILOR

- 1) Achse 107, 6 mm, Bremsen C1/C2
- 2) Achse 110 mm, Bremsen D1/K1/H1
- 3) Achse 110 mm, Bremsen C1/C2/L1/L2, (100 Zähne)
- 4) Achse 110 mm, Bremsen C3/C5, (80 Zähne)

VOLKSWAGEN

- 1) 1976-96
- 5) Ch.21N-006786 -, 08/91-96, 22.5 mm Haltering
- 7) Ausser Zwillingsrad. Ch.28G-015892 - 21N-006785, 04/86-07/91, 20 mm Haltering
- 8) Ausser Zwillingsrad. Ch.21N-006786-, 08/91-96, 22.5 mm Haltering
- 9) Spiralfedern, 1979-82
- 10) Blattfedern, ch.-28-B-018540, 1979-81
- 11) Blattfedern, ch.28-B-018541-, 1981-82
- 12) 1979-82
- 13) Ch.-28-B-019162, 1979-81
- 14) Ch.28-B-019163-, 1981-82
- 15) 1983-96
- 16) 3500 kg, 1983-96
- 17) 4000 kg, 1983-96
- 18) 1984-96
- 19) 05/96 - 10/04
- 20) 05/96 - 10/04, Mod. LT 28, LT 35
- 21) 05/96 - 10/04, Mod. LT 46
- 22) 08/67 - 07/79
- 23) 08/71 - 12/73
- 24) 08/75 - 07/79
- 25) 08/70 - 07/92
- 26) 08/79 - 12/82
- 27) 08/79 - 12/84, Ch.-24-E-023827
- 28) 01/84 - 07/92, Ch.24-E-023828 -
- 29) 10/86 - 07/92
- 30) 01/84 - 07/92, Ch.24-E-023828 -
- 31) 08/85 - 07/92
- 32) 11/84 - 07/92
- 33) 08/75 - 07/92
- 34) 07/90 - 10/04
- 35) 10/92 - 10/04
- 36) 07/90 - 10/04, 800-1200 Kg
- 37) 10/92 - 10/04, 800-1200 Kg
- 38) 04/03 - 09/04, Ch.-7 H-4-017500, 7J-4-017500
- 39) 07/04 - 09/04, Ch.-7 H-4-017500, 7J-4-017500
- 40) 04/03 - 10/04
- 41) 07/04 - 10/04











Bemerkungen

VOLVO



- | | | |
|--|--|---|
| <p>1) Nabe 363067
 2) Achsschenkel 57 mm
 3) Ch.-20653
 4) Volle Räder, ch.20654-
 5) Speichenräder, ch.20654-
 6) Volle Räder. Speichenräder, -1503875
 7) Speichenräder 1503876-
 8) Ohne Radnabenvorgelege, ch.36634-
 9) Mit Radnabenvorgelege
 10) Ohne Radnabenvorgelege
 11) Volle Räder
 12) Speichenräder
 13) Ch.-6997
 14) Volle Räder, ch.6998-
 15) Speichenräder, ch.6998-
 16) Harte Federung
 17) Weiche Federung
 18) Ch.-7050
 19) Ch.7051-
 20) Ch.-23510
 21) Ch.23511-
 22) Ch.-2376
 23) Ch.2377-
 24) Ch.-6450
 25) Ch.6451-
 26) Ch.-703
 27) Ch.704-
 28) Ch.-21671
 29) Ch.21672-
 30) Ch.-3145 (annähernd)
 31) 31) Ch.3146 (annähernd)-6871
 32) Ch.6872-
 33) Ch.-2728
 34) Ch.2729-6871
 35) ABS/Ohne-ABS
 36) Halbstarre Achse
 37) Für Fahrzeuge mit festem Aufbau
 38) Für Fahrzeuge ohne festen Aufbau
 39) Scheibenräder,
 Lochkreisdurchmesser 335 mm
 40) ABS/Ohne-ABS, Volle Räder,
 Lochkreisdurchmesser 335 mm
 41) Volle Räder, ch.-27087
 42) Volle Räder, ch.27088-
 43) Speichenräder, Nabe 20", ch.-27087
 44) Speichenräder, Nabe 22", ch.-27087
 45) Speichenräder, ch.27088-
 46) Speichenräder, Nabe 20"
 47) Speichenräder, ohne Radnabenvorgelege
 48) Volle Räder, ch.-19745
 49) Volle Räder, ch.19746-
 50) Mit Luftfederung und spezieller
 Konstruktion
 51) Mit S-ride und Einzelrädern
 52) Scheibenrad, ältere Modelle
 53) Speichenrad, ältere Modelle
 54) Baustellenfahrzeug mit starrer Vorderachse
 und grösserer Bodenfreiheit des Rahmens
 55) Speichenräder, ABS/Ohne-ABS
 56) Volle Räder, ABS/Ohne-ABS
 57) Scheibenrad BGT 18/21/26 mit
 Blattfederung hinten
 58) Volle Räder, Luftgedert, S-ride, mit
 Hinterachslenkung</p> | <p>59) Luftgedert mit Hinterachslenkung
 60) ABS/Ohne-ABS, mit Blattfederung
 61) Ch.-12099
 62) Ch.12100-
 63) Ch.12001-
 64) Volle Räder, ch.-11549
 65) Volle Räder, ch.11550-
 66) Ch.-26821
 67) Ch.26822-
 68) Volle Räder, ch.-40640, ABS/Ohne-ABS
 69) Speichenräder, Nabe 20", ohne
 Radnabenvorgelege
 70) Speichenräder, Nabe 24", ohne
 Radnabenvorgelege
 71) Volle Räder, ch.-20876, ABS/Ohne-ABS
 72) Volle Räder, ch.20877-, ABS/Ohne-ABS
 73) Volle Räder, ch.25001-40640, mit
 Lochkreisdurchmesser 335 mm.
 74) Speichenräder, Nabe 20", ch.25001-40640
 75) Speichenräder, Nabe 24", ch.25001-40640
 76) Luftgedert, ch.-25000
 77) S-ride, Hinterradlenkung, ch.25001-40640
 78) Volle Räder, mit Radnabenvorgelege
 79) Ch.-52439
 80) Ch.52440-
 81) Volle Räder, ch.306000-, mit
 Lochkreisdurchmesser 335 mm
 82) Speichenräder, Nabe 20" oder 24",
 ch.306000-
 83) Volle Räder, ch.306000-, mit
 Lochkreisdurchmesser 335 mm,
 ABS/Ohne-ABS
 84) Volle Räder, ch.-46315
 85) Volle Räder, ch.46316-, ABS/Ohne-ABS
 86) Speichenräder, Nabe 24", ch.49001-
 87) Volle Räder, Nabe 20", 22.5" oder 24"
 88) Baustellenfahrzeug mit starrer Vorderachse
 89) Speichenräder, Nabe 24"
 90) Ch.-36763
 91) Ch.36764-
 92) Ch.-65820
 93) Speichenräder, Nabe 20" oder 24",
 ch.-65820
 94) Volle Räder, ohne Radnabenvorgelege
 95) Volle Räder, ch.-22914
 96) Volle Räder, ch.22915-
 97) Speichenräder, Nabe 20", ch.34001-
 98) Speichenräder, Nabe 24", ch.34001-
 99) Luftgedert
 100) Sondermodell, super volym S-10609,
 S-10610, S-10801, S-11010, S-97024,
 S-97025, ch.314000-
 101) Speichenräder, Nabe 20" oder 24"
 102) Speichenrad, mit einfacher Untersetzung
 103) Tandem-Achse mit Aussenplaneten-,
 Untersetzung
 104) Nicht angetriebenes Einzelrad, Scheibenrad
 105) Nicht angetriebenes Zwillingrad,
 Scheibenrad
 106) Ch.-15169
 107) Ch.15170-
 108) Volle Räder, ch.-8779
 109) Volle Räder, ch.8780-
 110) Speichenräder, ch.-12000
 111) Speichenräder, Nabe 20", ch.12001-
 112) Speichenräder, Nabe 24", ch.12001-</p> | <p>113) Speichenräder, Nabe 22", 22.5" oder 24"
 114) Speichenräder, Nabe 20", Blattfederung,
 ABS/Ohne-ABS
 115) Speichenräder, Nabe 24", Blattfederung
 116) Speichenräder, Nabe 20", Luftgedert
 117) Speichenräder, ch.314000-, Luftgedert,
 hinten
 118) Sondermodell, super volym; 1) S-10099,
 S-10365, S-10803, S-11011 2) S-10111,
 S-10112, S-97024, S-97025
 119) Ch.7980
 120) Ch.7981-
 121) Ch.-3404
 122) Ch.3405-7980
 123) Ch.-5256
 124) Ch.5257-
 125) B 6F
 126) B 6FA
 127) Ch.865-.Ohne ch. 873-875, Ölgeschmiert
 128) B 6F, B 609, B 610
 129) B 6FA, ch.-404, Nabe 6772232
 130) B 6FA, ch.405-
 131) Ch.20000-
 132) Ch.-10521, Fettgeschmiert
 133) Ch.10522-.Ölgeschmiert
 134) Fettgeschmiert, mit Hinterachslenkung
 135) Ölgeschmiert, mit Hinterachslenkung.
 ABS/Ohne-ABS
 136) Ölgeschmiert
 137) Ch.-3906
 138) Ch.3907-
 139) Ch.4308-.ABS
 140) Mit FAT 5,0
 141) CHID -B169140. Volle Räder,
 Lochkreisdurchmesser 335 mm
 142) Ohne ABS. Volle Räder,
 Lochkreisdurchmesser 335 mm
 143) Nabe 6774825. Mit FAT 4,7
 144) CHID -B170985
 145) CHID B170986-
 146) S-60677, S-60936
 147) Volle Räder, Lochkreisdurchmesser 335 mm,
 Luftgedert
 148) Volle Räder, Lochkreisdurchmesser 335 mm,
 BAT 11,5. Blattfederung
 149) 6X2 TAG (HENDRICKSON)
 150) Nabe 6774825,6795568
 151) Sondermodell; S-60945, S-60990,
 S-60993, S-61208, S-61230
 152) B 6FA, ch.-404. (Erzt. 6772232, 6770991,
 6771541, 960234, 6772691, 95678,
 18665. One pcs of each)
 153) ABS/Ohne ABS. Ch.5000-
 154) Ch.5000-
 155) CHID. -A 276505, -B 190367, -563621
 156) BAT 10.0, BAT 10.9, BAT 11.2
 157) BAT 11.5, BLF-B, BAT 13.0
 158) BAT 11.5 LUF-B
 159) Mit FAT 4.7
 160) WTT, -D275
 161) Ch.-A286102, -B207062, D120498</p> |
|--|--|---|















Comment utiliser le catalogue.













Marques et modèles	Essieux avant/arrière	Essieu	Kit complet	Kit accessoires	Roulement extérieur/ Joint d'étanchéité	Roulement intérieur/ Joint d'étanchéité	Kit de roulements	Désignation du roulement	Joint d'étanchéité	Remarques
Exemple 										
DAF			VKBA 5240					L 68149/110/Q 07087 X/ K-07210 X		
Sherpa 285, 300, 310, 350	•				•			VKHB 2237 VKHB 2238		
		○						VKHB 2246 VKHB 2239		2), 22)
Sherpa 240, 310, 330 (M1 210)	•		VKBA 5240					L 68149/110/Q 07087 X/ K-07210 X		19), 21)
		○			•			VKHB 2237 VKHB 2238		
								VKHB 2246 VKHB 2239		2), 18)
F 400 Ser.	•	28 N	VKBA 5240					L 68149/110/Q 07087 X/ K-07210 X		
					•			VKHB 2237 VKHB 2238		

Contenu des kits



	A	B	C	D	E	F	G	H	I	J	K	L		
VKA 4004							1		1				VOLVO	• ○
VKA 4026							1		1				VOLVO	• ○
VKA 4036							2	1					SCANIA	• ○
VKA 4038							1	1					SCANIA	• ○
VKA 4094							2	1					MERCEDES-BENZ	• ○
VKA 4095							1	2					MERCEDES-BENZ	• ○

											
A	B	C	D	E	F	G	H	I	J	K	L
Roulement	Rondeller frein	Ecrou	Entre-toise	Bague de blocage	Circlip	Joint d'étanchéité	Joint	O-ring	Bague d'usure	Goupille	Accessoires



VKBA = VKHB + VKHB + VKA/VKS

						
						
VKBA 5025 VKBA 5026	VKHB 2056 VKHB 2059	VKHB 2057 VKHB 2007	VKS 6290			

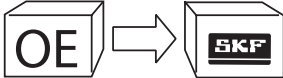

Listes de correspondance constructeurs – SKF

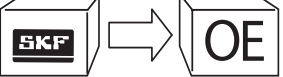
		
BPW 02.5664.26.57 02.5664.46.57 02.5664.55.57	VKS 6285 VKS 6287 VKS 6250 VKS 6251	0174592 0174595 0190069 0221664 0266487
	VKHB 2043 VKHB 2141 VKS 6171 VKHB 2222 VKHB 2223	FIAT / IVECO 1101597 1102042
		VKHB 2060 VKHB 2282 VKHB 2283





SKF – Listes de correspondance constructeurs

	
VKBA 519 VKBA 523 VKBA 528	VW VW FORD FORD MERCEDES BENZ
211 498 071 211 498 071 BS 5 007 029 5 007 028 116 220 00 51	VKBA 3616
	RENAULT / RVI OPEL OPEL OPEL
	77 01 206 742 44 08 669 91160087 77 01 206 848 11 00 00 00

Roulement - SKF VKHB

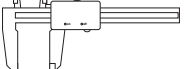
		
07087 X/K-07210 X 100 200 100	VKHB 2238 VKHB 2268 VKHB 2269	32310 TN9 32311 12
	VKHB 2303 VKHB 2304	30500/39520/Q 30500/39520/Q
		VKHB 2175 VKHB 2176







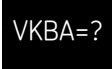

Recherche par dimensions (joint)

			
d	D	W	
44,0 53,0	85,0 97,0	10,0/8,0 8,0 13,0	VKS 6229 VKS 6219
			VKHB 2238 VKHB 2268
d	D	W	
117,4 118,0	142,8	12,7 27,0	VKS 6108 VKS 6109
			VKHB 2303 VKHB 2304





Symboles

Symboles utilisés dans le catalogues

	Nouveaux kits		VKBA=? VKBA=VKHB+VKHB+VKA/VKS
	Liste des marques et modèles, poids lourds		Liste de correspondance constructeurs – SKF
	Liste des marques et modèles, bus		SKF – Liste de correspondance constructeurs
	Liste des marques et modèles, remorques et semi-remorques		Roulement – SKF VKHB
	Contenu des kits		Recherche par dimensions (joint)

Symboles universels

	Jusqu'à
	A partir de
	Remplacements
	Kits annulés
	Outils

Abréviations

Ch.	Référence du châssis
Forward rear axle	Pont arrière antérieur
Rear rear axle	Pont arrière postérieur
Trailing axle	Essieu porteur

VKBA XXXX	Disponibles
VKHB XXXX	Disponibles
VKA XXXX	Disponibles
VKS XXXX	Disponibles
VKN XXX	Disponibles

Remarques

BPW

- 1) Camion surbaissé
- 2) Sauf camion surbaissé

CITROËN

- 1) 09/81 - 12/89, Ch.-604496
- 2) 01/89 - 03/04, Ch.604497 -
- 3) 02/91 - 03/94
- 4) 01/87 - 12/89, Ch.-604496
- 5) 01/89 - 02/94, Ch. 604497 -
- 6) 09/81 - 12/86, Roue gauche, Ch.-289710, chargement: 1000, 1300 Kg
- 7) 09/81 - 12/86, Roue droite, Ch.-289710, chargement: 1000, 1300 Kg
- 8) 09/81 - 03/94, Roue gauche, chargement:1800 Kg
- 9) 09/81 - 03/94, Roue droite, chargement: 1800 Kg
- 10) 01/86 - 03/94, Roue gauche, Ch.289711-, chargement: 1000, 1300, 1400 Kg
- 11) 01/86 - 03/94, Roue droite, Ch.289711-, chargement: 1000, 1300, 1400 Kg
- 12) 01/87 - 02/94,
- 13) 02/94 - 04/02, Ch.-16194399, chargement:1000, 1400 Kg
- 14) 02/94 - 04/02, Ch.-16194399, chargement: 1800 Kg
- 15) 02/94 - 04/02, Ch.16194400 -, chargement: 1000, 1400 Kg
- 16) 02/94 - 04/02, Ch.16194400 -, chargement: 1800 Kg
- 17) 04/02 - 09/04, chargement: 1000, 1400 Kg
- 18) 04/02 - 09/04, chargement: 1800 Kg
- 19) 03/94 - 04/02, Ch.-16194399, chargement: 1000, 1400 Kg
- 20) 03/94 - 04/02, Ch.-16194399, chargement: 1800 Kg
- 21) 03/94 - 04/02, Ch.16194400 -, chargement: 1000, 1400 Kg
- 22) 03/94 - 04/02, Ch.16194400 -, chargement: 1800 Kg
- 23) 08/96 - 04/02, Ch.-16194399, chargement: 1000, 1400 Kg
- 24) 08/96 - 04/02, Ch.-16194399, chargement: 1800 Kg
- 25) 08/96 - 04/02, Ch.16194400 -, chargement: 1000, 1400 Kg
- 26) 08/96 - 04/02, Ch.16194400 -, chargement: 1800 Kg
- 27) 02/94 - 04/02, Ch.16194400 -
- 28) Frein à tambour
- 29) Frein à disques

DAF

- 2) Roues jumelées
- 3) Voie de 1718 mm, roue à 10 trous
- 4) Voie de 1655 mm, roue à 8 trous
- 5) Sans centrage de moyeu
- 6) Avec centrage de moyeu
- 7) Avec centrage de moyeu. Etanchéité noire
- 8) Avec centrage de moyeu. Etanchéité bleue
- 9) Avec réducteur dans les moyeux

- 10) Sans FAR
- 11) Avec FAR
- 12) Sans FA, FT
- 13) Avec FA, FT
- 14) Sans centrage de moyeu. Etanchéité noire
- 15) Sans centrage de moyeu. Etanchéité bleue
- 16) Etanchéité noire
- 17) Etanchéité bleue
- 18) 1983-85
- 19) Ch. 237886-, sauf roues jumelées
- 21) 1984-85
- 22) 1985-89
- 23) -12/89
- 24) Etanchéité/ABS, no intégration

FIAT-IVECO

- 4) Roue gauche
- 5) Roue droite
- 8) Roue gauche, 06/79-06/81
- 9) Roue droite, 06/79-06/81
- 10) 10/77-06/81
- 11) Roue gauche, 06/81-09/84
- 12) Roue droite, 06/81-09/84
- 13) 06/81-09/84
- 14) Roue gauche, 10/84-88
- 15) Roue droite, 10/84-88
- 16) 10/84-88
- 17) 03/85-88
- 18) Ch.-604496, 1982-89
- 19) Ch.604497-, 1989-93
- 20) Roue gauche, ch.-278757, 1982-86
- 21) Roue droite, ch.-278757, 1982-86
- 22) Roue gauche, ch.278758-, 1986-93
- 23) Roue droite, ch.278758-, 1986-93
- 24) 1982-86
- 25) Ch.-604496, 1986-89
- 26) Roue gauche, 1986-93
- 27) Roue droite, 1986-93
- 28) 10/77-12/86
- 29) 01/87-
- 30) Sans 50-9 D, 50-9 V
- 31) 04/91-04/92
- 32) 01/85-
- 33) Freins à disques
- 34) 12/85-
- 36) 1991-94
- 37) Roue gauche, 1991-94
- 38) Roue droite, 1991-94
- 39) Sauf ABS
- 40) Sauf modèles pour la Suisse
- 41) Modèles pour la Suisse
- 42) Rapport 4.23/1
- 43) Sauf rapport 4.23/1
- 44) Rapport 4.23/1. Sauf la Suisse
- 45) Sauf rapport 4.23/1. Sauf la Suisse
- 46) Sauf rapport 3.79/1
- 47) Rapport 3.79/1
- 48) Ch.-173788
- 49) Ch.173789-. Essieu -1824487
- 50) Ch.173789-. Essieu 1824488-
- 51) Ch.173789-
- 52) Alésage du roulement intérieur: 95 mm
- 53) Alésage du roulement intérieur: 105 mm. Essieu -1824487

- 54) Alésage du roulement intérieur: 105 mm. Essieu 1824488-
- 55) Essieu de direction. Essieu rigide, piece detachee 717196
- 56) Essieu rigide, pièce détachée 7177168
- 57) Alésage du roulement intérieur: 100 mm
- 58) Essieu -1824487
- 59) Essieu 1824488-
- 60) Roue gauche, 06/79-01/97
- 61) Roue droite, 06/79-01/97
- 62) 06/81-01/97
- 63) Roue gauche, 06/81-88
- 64) Roue droite, 06/81-88
- 65) Sauf rapport 5.22/1. -02/96
- 66) Rapport 5.22/1. -02/96
- 67) Roue gauche, 06/79-02/96
- 68) Roue droite, 06/79-02/96
- 69) 10/77-09/84
- 70) Sauf "Iveco check control"
- 71) "Iveco check control"
- 72) Roue gauche, -02/96
- 73) Roue droite, 02/96
- 74) -02/96
- 75) Rapport 5.62/1
- 76) Sauf rapport 5.62/1
- 77) ABS
- 78) Roue gauche, 03/85-88
- 79) Roue droite, 03/85-88
- 81) -02/96
- 82) 03/96-
- 83) 1994-
- 84) 1996-
- 85) Roulement à rouleaux coniques à simple rangée
- 86) Roulement à rouleaux coniques à double rangée
- 87) Essieu rigide
- 88) Essieu de direction
- 89) Traction avant
- 90) Traction arrière
- 91) Roue avant gauche avec roulement à rouleaux coniques à simple rangée , 03/96 - 12/99
- 92) Roue avant droite avec roulement à rouleaux coniques à simple rangée , 03/96 - 12/99
- 93) Roulements à rouleaux coniques à double rangée , 03/96 - 12/99
- 94) Bis 05/89
- 95) 06/89 - 01/97
- 96) 01/96 - 12/99
- 97) Bis 12/99
- 98) 05/99 - 08/03
- 99) 06/81 - 01/97
- 100) 04/02 - 01/04
- 101) 07/02 - 01/04
- 102) Pickup 1100, 1500 Kg
- 103) Pickup 1800 Kg

FORD

- 1) 1965-91
- 2) 07/74-12/77
- 3) 08/65-12/77
- 6) 11/73-12/77
- 7) 01/78-10/85

Remarques

- 8) Roue gauche, 11/85-91
- 9) Roue droite, 11/85-91
- 10) 11/85-91
- 11) 1992-97
- 12) 01/81-03/87
- 13) 03/87-12/92
- 14) 04/82 - 09/87
- 15) 10/87 - 12/90 Roue gauche
- 16) 10/87 - 12/90 Roues droite
- 18) 01/00 - 10/04
- 19) 01/00 - 10/04, Sauf ABS, Chargement 1000 Kg, traction avant
- 20) 01/00 - 10/04, ABS, Chargement 1000 Kg, traction avant
- 21) 07/03 - 10/04, sauf ABS, chargement 2000 Kg, traction avant
- 22) 07/03 - 10/04, ABS, chargement 2000 Kg, traction avant
- 23) 01/00 - 10/04, roue simple, traction arrière
- 24) 01/00 - 10/04, roues jumelées, traction arrière
- 25) 03/04 - 10/04, Sauf ABS, chargement 2000 Kg
- 26) 03/04 - 10/04, ABS, chargement 2000 Kg

GIGANT (SAE)

- 1) Suspension pneumatique type N
- 2) Essieu Protec

FRUEHAUF

- 1) Essieu 107, 6 mm, frein C/C2
- 2) Essieu 110 mm, frein D1/K1/H1
- 3) Essieu 110 mm, frein C1/C2/L1/L2 (100 dents)
- 4) Essieu 110 mm, frein C3/C5 (80 dents)

MAN

- 1) -11/93
- 2) 12/93-
- 3) W25/86-W27/90
- 4) W28/90-
- 5) Sauf ABS
- 6) ABS
- 7) 01/90-
- 8) Moyeu 81.35701.0081
- 9) Moyeu 81.35701.0127
- 10) 20" TRILEX
- 11) Moyeu 81.35701.0141
- 12) Sauf "TRILEX"
- 13) "TRILEX"
- 14) -W18/94
- 15) W19/94-
- 16) -W27/96
- 17) W28/96-, 19.5" Moyeu
- 18) W28/96-, 20/22.5" Moyeu

MERCEDES-BENZ

- 1) 02/88 - 02/96

- 2) 02/88 - 02/96, Ch.-128165
- 3) 1983-94
- 4) Ch.-48630
- 5) Ch.48631-
- 6) Moteur Diesel ch.-17768, moteur à essence ch.-1288
- 7) Moteur Diesel ch.17769-78114, moteur à essence ch.1289-4706
- 8) Moteur Diesel ch.78115-, moteur à essence ch.4707-
- 9) Alésage du roulement intérieur: 55 mm
- 10) Essieu -1358880
- 11) Essieu 1358881-
- 12) 02/88 - 02/96, Ch.128166-
- 13) Essieu -1278813
- 14) Essieu 1278814-
- 15) 02/88 - 05/92, Pickup
- 16) 02/73 - 12/77
- 17) 01/95 - 05/02, jusqu'à essieu: S213915/Y245976
- 18) 01/95 - 05/02
- 19) Essieu -1390839
- 20) Essieu 1390840-
- 21) Essieu -1278313
- 22) Essieu 1278314-
- 23) 02/95 - 07/04, jusqu'à essieu: S213915/Y245976
- 24) Freins à tambours
- 25) ABS, Essieu -02198
- 26) ABS, Essieu 02199-
- 27) Essieu - 724723
- 28) Essieu 724724-
- 29) Moyeu 3553564401
- 30) Moyeu 3463563001
- 31) 02/95 - 07/04
- 32) 02/96 - 05/02, jusqu'à essieu: S213915/Y245976
- 33) 02/96 - 05/02
- 34) 09/96 - 07/04
- 35) 02/96 - 07/04
- 37) Moyeu 668 356 01 01, 668 356 02 01
- 38) Moyeu 972 356 01 01
- 39) Moyeu 976 356 11 01
- 40) Moyeu 678 356 04 01
- 41) Moyeu 675 356 01 01
- 42) Freins a disques
- 43) Moyeu 942 334 08 01
- 44) Moyeu 942 334 07 01

MERITOR (ROR)

- 1) Lubrification à la graisse

MONTENEGRO

- 1) Essieu 061001243, 061001243 A
- 2) Essieu 06-1-1068
- 3) Essieu 06-1-1176, 061001231
- 4) Essieu 061001271
- 5) Essieu 061001231 A
- 6) Essieu 061001230, 061001230 A
- 7) Essieu 06-1-1025
- 8) Essieu 061001170 A
- 9) Essieu 061001299

- 10) Essieu 061001210, 061001210 B, 061001295
- 11) Essieu 06-1-1103, 06-1-1170
- 12) Essieu 06-1-1100, 06-1-1102, 06-1-1106, 06-1-1108, 06-1-1173, 06-1-1174

OPEL

- 1) 09/00 - 10/01, Roue:15", Ch.-B 000010, code de moteur :F9Q-770
- 2) 09/00 - 10/01, roue:15", Ch. B 000011-, code de moteur: F9Q-770
- 3) 07/98 - 10/01, roue:16"
- 4) 07/98 - 10/01, pickup, roue:15", Ch.-B 0000514, B 006055, code de moteur: S8U-702
- 5) 07/98 - 10/01, camionette, autobus, Dumpertruck, roue: 15", Ch.-B 051615, code de moteur: S9W-702
- 6) 07/98 - 10/01, pickup, roue:15", Ch.B 0000515-, B 006056-, code de moteur: S8U-702
- 7) 07/98 - 10/01, camionette, autobus, Dumpertruck, roue:15", Ch.B 051616-, code de moteur:S9W-702
- 8) 07/98 - 10/01, roue:15"
- 9) 07/98 - 10/01,roue:16"
- 10) 08/01 - 08/05, sauf ABS, Ch.- 3V613233
- 11) 08/01 - 08/05, ABS, Ch.- 3V613233
- 13) 08/01 - 08/05,

PEUGEOT

- 1) 01/83 - 11/88
- 2) 10/90 - 01/01
- 3) 09/81 - 12/89, Ch.-604496
- 4) 01/89 - 09/90, Ch.604497-
- 5) 09/81 - 12/85, roue gauche, chargement 1000 Kg, 1300 Kg, Ch.-244300
- 6) 09/81 - 01/01, roue gauche, chargement 1400 Kg
- 7) 09/81 - 01/01, roue gauche, chargement 1800 Kg
- 8) 09/81 - 01/01, roue droite, chargement 1400 Kg
- 9) 09/81 - 01/01, roue droite, chargement 1800 Kg
- 10) 01/86 - 11/88, roue gauche, chargement 1000 Kg, 1300 Kg, Ch. 244301-
- 11) 09/81 - 12/85, roue droite, chargement 1000 Kg, 1300 Kg, Ch.-244300
- 12) 01/86 - 11/88, roue droite, chargement 1000 Kg, 1300 Kg, Ch.244301-
- 13) 10/90 - 01/01, roue gauche, chargement 1000 Kg, 1300 Kg
- 14) 10/90 - 01/01, roue droite, chargement 1000 Kg, 1300 Kg
- 15) 1967-09/70
- 16) 10/70-80
- 17) 1967-80
- 18) 1980-88
- 19) 03/94 - 04/02, chargement 1000 Kg, 1400 Kg, Ch.-16194399
- 20) 03/94 - 04/02, chargement 1800 Kg, Ch.-16194399

Remarques

21) 03/94 - 04/02, chargement 1000 Kg, 1400 Kg, Ch.16194400-	52) -03/93	120) 05/89 - 01/01
22) 03/94 - 04/02, chargement 1800 Kg, Ch.16194400-	53) -08/91	121) 05/89 - 01/01, pickup, Model type:PC
23) 04/02 - 07/04, chargement 1000 Kg, 1400 Kg	54) -07/90	122) 05/89 - 01/01, camionnette, autobus, inner bearing 35x72x24.5 mm
24) 04/02 - 07/04, chargement 1800 Kg	55) 08/90-	123) 05/89 - 01/01, camionnette, autobus, inner bearing 35x62x18.3 mm
25) 07/96 - 04/02, chargement 1000 Kg, 1400 Kg, Ch.-16194399	56) -02/91	124) 03/01 - 11/02, Except ABS
26) 07/96 - 04/02, chargement 1800 Kg, Ch.-16194399	57) 03/91-	125) 03/01 - 11/02, with ABS
27) 07/96 - 04/02, chargement 1000 Kg, 1400 Kg, Ch.16194400-	58) -09/90	126) 11/02 - 02/04,
28) 07/96 - 04/02, chargement 1800 Kg, Ch.16194400-	59) -02/92	127) 03/01 - 02/04
29) 03/04 - 04/02, Ch.16194400-	60) 03/92-	128) 08/80 - 07/98, camionnette, autobus,
30) 04/02 - 07/04	61) -05/95	129) 09/80 - 07/98, Flatbad,
31) 10/01 - 04/02	62) 06/95-	130) 07/98 - 03/00
32) 11/00 - 09/01, chargement 1000 Kg, 1400 Kg	63) Freins à tambours	131) 03/00 - 02/02
33) 11/00 - 09/01, chargement 1800 Kg	64) Freins à disques	132) 07/98 - 01/01
34) 07/96 - 04/02, freins à tambours	65) -02/85	133) 07/98 - 10/01, camionnette, autobus
35) 07/96 - 04/02, freins à disques	66) 03/85-	134) 07/98 - 10/01, camionnette, pickup
36) 01/86 - 01/01, roue gauche, chargement 1000 Kg, 1300 Kg, Ch.244301-	67) -17/11/93	135) 09/00 - 02/04, camionnette, freins tambours
37) 01/86 - 01/01, roue droite, chargement 1000 Kg, 1300 Kg, Ch.244301-	68) 18/11/93-	136) 09/00 - 02/04, camionnette, freins tambours
	69) 10/87-	137) 09/00 - 02/04, autobus, freins tambours
	70) ABS	138) 09/00 - 02/04, autobus, freins disques
	71) -12/92	139) 09/00 - 02/04, pickup, freins tambours
	72) 01/93-	140) 09/00 - 02/04, pickup, freins disques
	73) 01/77-14/03/84	141) 07/98 - 01/01, camionnette, freins tambours
	74) 03/86-	142) 07/98 - 01/01, camionnette, freins disques
	75) sauf ABS. -08/91 sauf "Trilex"	143) 10/01 - 02/04, camionnette, freins tambours
	76) ABS. -08/91. Sauf "Trilex"	144) 10/01 - 02/04, camionnette, freins disques
	77) "Trilex" 20".-03/93.	145) 07/98 - 01/01, autobus, freins tambours
	78) "Trilex" 24".-03/93.	146) 07/98 - 01/01, autobus, freins disques
	79) 09/91-03/93. Sauf "Trilex"	147) 10/01 - 02/04, autobus, freins tambours
	80) -02/86	148) 10/01 - 02/04, autobus, freins disques
	81) -12/87	149) 07/98 - 01/01, pickup, freins tambours
	82) Ecrou M75. -05/91	150) 07/98 - 01/01, pickup, freins disques
	83) Ecrou M70. -05/91	151) 10/01 - 02/04, pickup, freins tambours
	84) Sauf-ABS	152) 10/01 - 02/04, pickup, freins disques
	85) ABS	153) 07/98 - 10/01, camionnette, freins tambours
	86) -05/95	154) 07/98 - 10/01, camionnette, freins disques
	87) 06/95-	155) 07/98 - 10/01, pickup, freins tambours
	88) -03/89	156) 07/98 - 10/01, pickup, freins disques
	89) 04/89-	157) 10/03 - 02/04, camionnette, freins tambours
	90) 1973-1989	158) 10/03 - 02/04, camionnette, freins disques
	91) Sauf moteur G9T	159) 10/03 - 02/04, autobus, freins tambours
	92) Avec moteur G9T	160) 10/03 - 02/04, autobus, freins disques
	96) 03/89 - 04/89, camionnette, autobus,roulement intrerieur 35x72x24.5 mm	161) 10/03 - 02/04, pickup, freins tambours
	97) 03/89 - 04/89, camionnette, autobus, roulement interieur 35x62x18.3 mm	162) 10/03 - 02/04, pickup, freins disques
	98) 05/89 - 10/97, pickup	
	100) 03/80 - 04/89, camionnette, autobus	
	101) 03/80 - 04/89, pickup	
	102) 18/08/98 -	
	103) - 31/03/98	
	104) 01/04/98 -	
	105) - 27/08/98	
	106) - 24/08/98	
	107) - 17/08/98	
	108) Roue simple	
	109) Roues jumelées	
	110) 01/09/91 - 31/03/93	
	111) - 11/04/2000	
	112) 12/04/2000 -	
	113) 03/80 - 04/89	
	114) 03/80 - 12/83,camionnette, autobus	
	115) 03/80 - 02/89, All models	
	116) 01/84 - 12/85, camionnette, autobus,	
	117) 01/86 - 02/89, camionnette, autobus	
	118) 03/89 - 04/89	
	119) 05/89 - 01/01, camionnette, autobus	

RVI

12) -14/06/85
13) 17/06/85-
14) -12/82
15) 01/83-
16) -15/11/85
17) 18/11/85-
18) -1986
19) 1987-
22) 07/86-
23) -14/03/84
24) 15/03/84-
25) 10/84-01/86
26) 02/86-
27) -09/84
28) -01/86
29) 10/84-
30) -09/83
31) 10/83-
33) -08/79
34) 09/79-
35) -08/84 MOT 62030
36) -12/83
37) 01/84-
38) -12/85
39) 01/86-
40) 12/92-
41) -05/91
42) 06/91-03/93
43) 04/93-
44) -08/84 MOT 62030. -N 1539
45) -08/84 MOT 62030. N 1540-
47) 09/93-
48) Sauf ABS. -08/91
49) ABS. -08/91
50) 09/91-03/93
51) 09/91-

SCANIA

1) Ch.-1032241
2) Ch.1032242-
3) Moyeu disque, ch.-103224
4) Moyeu disque, ch.1032242-
5) Moyeu étoile
6) Moyeu disque, ch.-1097602 SSS, ch.-4246024 SN
7) Moyeu disque, ch.1097603 SSS-, ch.4246025 SN-8)
8) Moyeu étoile, ch.-1105665 SSS, ch.-4238514 SN
9) Moyeu étoile, ch.1105666 SSS-, ch.4238515 SN-10)
10) Moyeu disque
11) Moyeu étoile, largeur du châssis: 2300 mm
12) Moyeu étoile 20" ou 22.5", ch.-1103187 SSS, ch.-4248317 SN

Remarques

- 13) Moyeu étoile 20" ou 22.5", ch.1103188 SSS-, ch.4248318 SN-14)
- 14) Moyeu étoile 24"
- 15) Ch.-1097602 SSS, ch.-4246024 SN
- 16) Ch.1097603 SSS-, ch.4246025 SN-17)
- 17) Moyeu disque, ch.-1033747
- 18) Moyeu disque, ch.1033748-
- 19) Moyeu étoile 20" ou 22", ch.-1103187 SSS, ch.-4248317 SN
- 20) Moyeu étoile 20" ou 22", ch.1103188 SSS-, ch.4248318 SN-21)
- 21) Moyeu disque, moyeu étoile
- 22) Moyeu disque (4x2, 6x2, 6x4)
- 23) Moyeu étoile, 20" ou 22.5", (4x2, 6x2, 6x4)
- 24) Moyeu étoile 24", garniture de freins, de 178 mm de large
- 25) Moyeu étoile 24", garniture de freins, de 203 mm de large
- 26) Twin steer axle
- 27) Moyeu étoile 20", 22.5" ou 24"
- 28) Sans réducteur dans les moyeux
- 29) Avec réducteur dans les moyeux
- 30) Moyeu disque, ch.-1029858
- 31) Moyeu disque, ch.1029859-
- 32) Moyeu disque, moyeu étoile 24"
- 33) Moyeu disque, moyeu étoile, 20" ou 22.5"
- 34) Moyeu disque, moyeu étoile, 20", 22.5" ou 24"
- 35) Moyeu disque, ch.-1161721 SSS, ch.-4292924 SN
- 36) Moyeu disque, ch.1161722 SSS-, ch.4292925 SN-37)
- 37) Moyeu disque, moyeu étoile 24", ch.-1180029 SSS
- 38) Moyeu disque, moyeu étoile 24", ch.1180030 SSS-39)
- 39) Moyeu disque, ch.-1850412
- 40) Moyeu disque, ch.1850413-
- 41) Suspension à lames, ch.-1801229
- 42) Suspension à lames, ch.1801230-
- 43) Suspension pneumatique, ch.-1802872
- 44) Suspension pneumatique, ch.1802873- Ch.-1801229
- 45) Ch.1801230-
- 46) Moyeu disque, ABS/Sauf-ABS
- 47) ABS/Sauf-ABS
- 48) Suspension pneumatique
- 49) Suspension pneumatique/ABS
- 50) Suspension pneumatique. Suspension trapeze
- 51) Suspension pneumatique. Suspension trapeze. ABS
- 52) Moyeu disque, ch.-1871409
- 53) Ch.1871410-1871595
- 54) Ch.1871596-
- 55) Ch.1871410-
- 56) Garniture de freins, de 5" de large
- 57) Garniture de freins, de 7" de large. Ch.1801196-
- 58) Ch.-1801195
- 59) Ch.1801196-
- 60) Ch.-1808231
- 61) Ch.1808232-
- 62) ABS/Sauf-ABS. Ch.-1808901, Ch.1808902-
- 63) ABS/Sauf-ABS. Ch.-1806768, Ch.1806769-
- 64) Moyeu pour essieu suivreur
- 65) Moyeu disque, ABS/Sauf Ch.-1808901, Ch.1808902-
- 66) Suspension pneumatique, 22.5" hub
- 67) Suspension pneumatique, 22.5" hub. ABS
- 68) ABS
- 69) Moyeu 8.25 x 22.5"
- 70) Moyeu 8.25 x 22.5". ABS
- 71) Moyeu 9.00 x 22.5"
- 72) Moyeu 9.00 x 22.5". ABS
- 73) 6.5 tons
- 74) 6.5 tons. ABS
- 75) 7.1 tons
- 76) 7.1 tons. ABS
- 77) 6.5 tons. Ch.-1820117
- 78) 6.5 tons. Ch.-1820117. ABS
- 79) 7.1 tons. Ch.-1820117
- 80) 7.1 tons. Ch.-1820117. ABS
- 81) ABS/Sauf-ABS. Ch.-1820117
- 82) Suspension pneumatique, ch.-1801229
- 83) Suspension pneumatique, ch.1801230-1802872
- 84) Moyeu disque, Sauf ABS, Ch.9015825-SAN,
- 85) Moyeu disque, ABS, ch.9015825-SAN, ch.4362207-SNL, ch.1226892-SSS
- 86) Moyeu étoile, ABS/Saus ABS
- 87) Moyeu disque, ABS/Saus ABS, ch.9015825-SAN, ch.4362207-SNL, ch.1226892-SSS
- 88) Moyeu disque, Sauf ABS, ch.9015825-SAN, ch.4362207-SNL, ch.1226207-SSS
- 89) Moyeu disque, Sauf ABS
- 90) Moyeu disque, Sauf ABS, RP/RBP 730
- 91) Sauf ABS, RP/RBP 832
- 92) Moyeu disque, ABS
- 93) Moyeu disque/Moyeu étoile, ABS/Saus ABS, ch.9015825-SAN, ch.4362207-SNL, ch.1226892-SSS SAN
- 94) Moyeu étoile, Sauf ABS
- 95) Moyeu disque, ch.1820118-, ABS
- 96) Moyeu disque, ch.1820118-, Sauf ABS
- 97) -ch. Scania Sodertalje 1242205, Scania Zwolle 4397541, Scania Angers 9034654, Scania Katrineholm 1833391
- 98) Moyeu disque, Freins a disques, ABS
- 99) Moyeu étoile de 22" ou 22.5"
- 100) RP/RBP 832
- 101) Moyeu 22", 22.5" ou 24"
- 102) Moyeu 20" ou 22.5", RBP/RP 730
- 103) Moyeu 24", RP/RBP 832
- 104) Moyeu disque, ch.-9015824 SAN, ch.-4365570 SNL, ch.-1226891 SSS
- 105) Moyeu disque, ABS, ch.-9015824 SAN, ch.-4362206 SNL, ch.-1226891 SSS
- 106) Moyeu disque, Freins a disques, ABS/Sauf ABS

SMB

- 1) Essieu 107, 6 mm, avec freins C1/C2
- 2) Essieu 110 mm, avec freins D1/K1/H1
- 3) Essieu 110 mm, avec freins C1/C2/L1/L2 (100 dents)
- 4) Essieu 110 mm, avec freins C3/C5 (80 dents)

TRAILOR

- 1) Essieu 107, 6 mm, avec freins C1/C2
- 2) Essieu 110 mm, avec freins D1/K1/H1
- 3) Essieu 110 mm, avec freins C1/C2/L1/L2 (100 dents)
- 4) Essieu 110 mm, avec freins C3/C5 (80 dents)

VOLKSWAGEN

- 1) 1976-96
- 5) Ch.21N-006786-, 08/91-96, Bague de blocage de 22.5 mm.
- 7) Sauf roue jumelée. ch. 28G-015892 - 21N-006785, 04/86- 7/91, Bague de blocage de 20 mm
- 8) Sauf roue jumelée. ch.21N-006786-, 08/91-96, Bague de blocage de 22.5 mm.
- 9) Ressorts hélicoïdaux, 1979-82
- 10) Ressorts à lames, ch.-28-B-018540, 1979-81
- 11) Ressorts à lames, ch.28-B-018541-, 1981-82
- 12) 1979-82
- 13) Ch.-28-B-019162, 1979-81
- 14) Ch.28-B-019163-, 1981-82
- 15) 1983-96
- 16) 3500 kg, 1983-96
- 17) 4000 kg, 1983-96
- 18) 1984-96
- 19) 05/96 - 10/04
- 20) 05/96 - 10/04, Mod. LT 28, LT 35
- 21) 05/96 - 10/04, Mod. LT 46
- 22) 08/67 - 07/79
- 23) 08/71 - 12/73
- 24) 08/75 - 07/79
- 25) 08/70 - 07/92
- 26) 08/79 - 12/82
- 27) 08/79 - 12/84, Ch.-24-E-023827
- 28) 01/84 - 07/92, Ch.24-E-023828 - 29) 10/86 - 07/92
- 30) 01/84 - 07/92, Ch.24-E-023828 - 31) 08/85 - 07/92
- 32) 11/84 - 07/92
- 33) 08/75 - 07/92
- 34) 07/90 - 10/04
- 35) 10/92 - 10/04
- 36) 07/90 - 10/04, 800-1200 Kg
- 37) 10/92 - 10/04, 800-1200 Kg
- 38) 04/03 - 09/04, Ch.-7 H-4-017500, 7J-4-017500
- 39) 07/04 - 09/04, Ch.-7 H-4-017500, 7J-4-017500
- 40) 04/03 - 10/04
- 41) 07/04 - 10/04

VOLVO

- 1) Moyeu 363067
- 2) Fusée de 57 mm
- 3) Ch.-20653
- 4) Moyeu disque, ch.20654-
- 5) Moyeu étoile, ch.20654-
- 6) Moyeu disque, moyeu étoile, -1503875
- 7) Moyeu étoile, 1503876-



Remarques



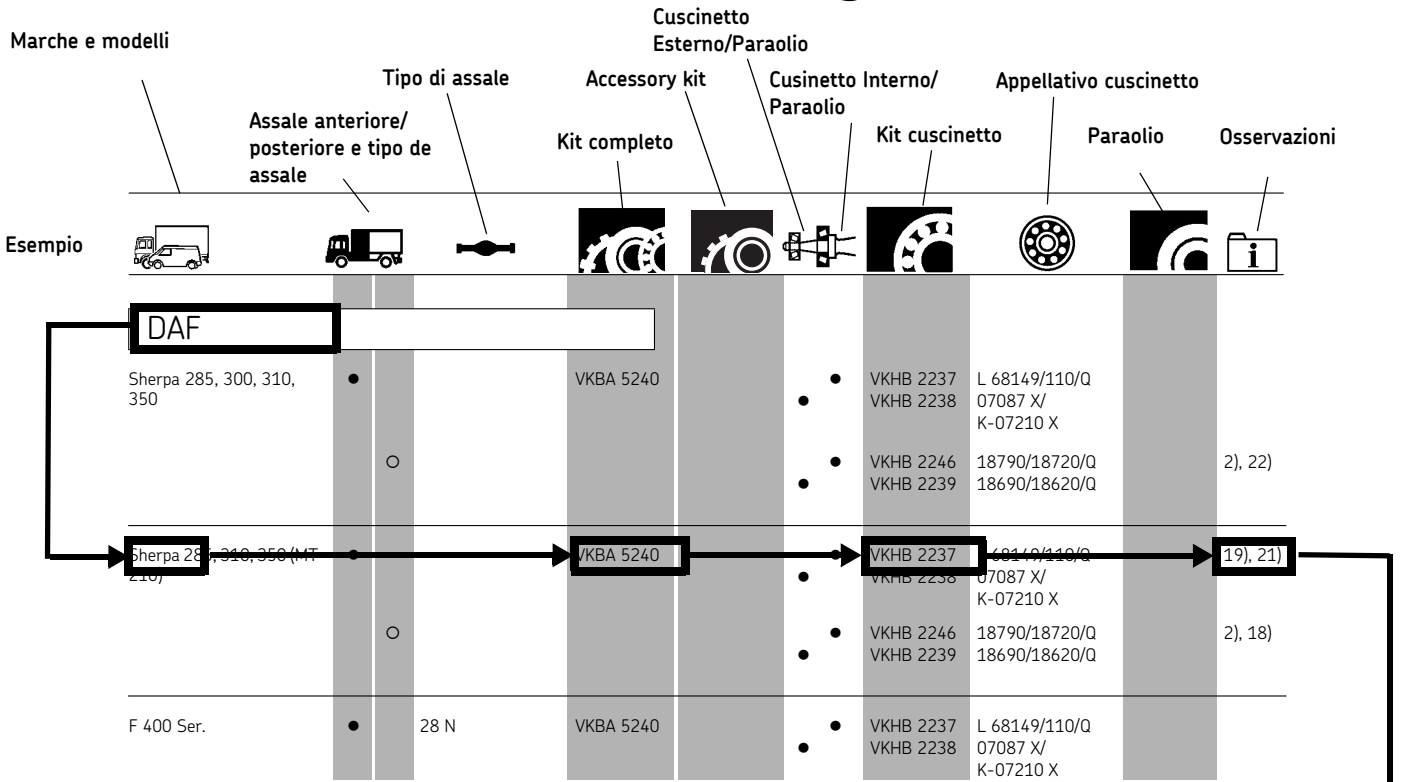









- 8) Sans réducteur dans les moyeux, ch.36634-
9) Avec réducteur dans les moyeux
10) Sans réducteur dans les moyeux
11) Moyeu disque
12) Moyeu étoile
13) Ch.-6997
14) Moyeu disque, ch.6998-
15) Moyeu étoile, ch.6998-
16) Suspension renforcée
17) Suspension souple
18) Ch.-7050
19) Ch.7051-
20) Ch.-23510
21) Ch.23511-
22) Ch.-2376
23) Ch.2377-
24) Ch.-6450
25) Ch.6451-
26) Ch.-703
27) Ch.704-
28) Ch.-21671
29) Ch.21672-
30) Ch.-3145 (approx.)
31) Ch.3146 (approx.)-6871
32) Ch.6872-
33) Ch.-2728
34) Ch.2729-6871
35) ABS/Sauf-ABS
36) Essieu semi-rigide
37) "Pour véhicules à construction rigide"
38) "Pour véhicules sans construction rigide"
39) Moyeu disque, diam. repart. boulons 335 mm
40) ABS/Sauf-ABS, moyeu disque, diam. repart. boulons 335 mm
41) Moyeu disque, ch.-27087
42) Moyeu disque, ch.27088-
43) Moyeu étoile de 20" hub, ch.-27087
44) Moyeu étoile de 22" hub, ch.-27087
45) Moyeu étoile, ch.27088-
46) Moyeu étoile de 20" hub
47) Moyeu étoile, sans réducteur dans les moyeux
48) Moyeu disque, ch.-19745
49) Moyeu disque, ch.19746-
50) Avec suspension pneumatique
51) Avec "S-ride" et monté en simple
52) Moyeu disque, modèles précédents
53) Moyeu étoile, modèles précédents
54) Véhicule de chantiers avec essieu avant droit à garde au sol sur elevee
55) Moyeu étoile, ABS/Sauf-ABS
56) Moyeu disque, ABS/Sauf-ABS
57) Moyeu disque BGT 18/21/26 avec suspension à lames arrière
58) Moyeu disque, avec suspension pneumatique, et direction arrière, "S-ride"
59) Avec suspension pneumatique et direction arrière
60) ABS/Sauf-ABS, avec suspension à lames
61) Ch.-12099
62) Ch.12100-
63) Ch.12001-
64) Moyeu disque, ch.-11549
65) Moyeu disque, ch.11550-
66) Ch.-26821
67) Ch.26822-
68) Moyeu disque, ch.-40640, ABS/Sauf-ABS
69) Moyeu étoile de 20", sans réducteur dans les moyeux
70) Moyeu étoile de 24", sans réducteur dans les moyeux
71) Moyeu disque, ch.-20876, ABS/Sauf-ABS
72) Moyeu disque, ch.20877-, ABS/Sauf-ABS
73) Moyeu disque, ch.25001-40640, diam. repart. boulons 335 mm
74) Moyeu étoile de 20", ch.25001-40640
75) Moyeu étoile de 24", ch.25001-40640
76) Avec suspension pneumatique, ch.-25000
77) Avec "S-ride" et monté en simple, ch.25001-40640
78) Moyeu disque, avec réducteur dans les moyeux
79) Ch.-52439
80) Ch.52440-
81) Moyeu disque, ch.306000-, diam. repart. boulons 335 mm
82) Moyeu étoile de 20" ou 24", ch.306000-
83) Moyeu disque, ch.306000-, diam. repart. boulons 335 mm. ABS/Sauf-ABS
84) Moyeu disque, ch.-46315
85) Moyeu disque, ch.46316-, ABS/Sauf-ABS
86) Moyeu étoile de 24", ch.49001-
87) Moyeu disque de 20", 22.5" ou 24"
88) Véhicule de chantiers, avec essieu avant droit
89) Moyeu étoile de 24"
90) Ch.-36763
91) Ch.36764-
92) Ch.-65820
93) Moyeu étoile de 20" ou 24", ch.-65820
94) Moyeu disque, sans réducteur dans les moyeux
95) Moyeu disque, ch.-22914
96) Moyeu disque, ch.22915-
97) Moyeu étoile de 20", ch.34001-
98) Moyeu étoile de 24", ch.34001-
99) Avec suspension pneumatique
100) Modèle spécial, super volume S-10609, S-10610, S-10801, S-11010. S-97024, S-97025, ch.314000-
101) Moyeu étoile de 20" ou 24"
102) Moyeu étoile, sans réducteur dans les moyeux
103) Essieu double avec réducteur dans les moyeux
104) Essieu suiveur simples roues, moyeu disque
105) Essieu suiveur roues jumelées, moyeu disque
106) Ch.-15169
107) Ch.15170-
108) Moyeu disque, ch.-8779
109) Moyeu disque, ch.8780-
110) Moyeu étoile, ch.-12000
111) Moyeu étoile de 20" hub, ch.12001-
112) Moyeu étoile de 24" hub, ch.12001-
113) Moyeu étoile de 22", 22.5" ou 24" hub
114) Moyeu étoile de 20", avec suspension à lames, ABS/Sauf-ABS
115) Moyeu étoile de 24", avec suspension à lames
116) Moyeu étoile de 20", avec suspension pneumatique
117) Moyeu étoile, ch.314000-, avec suspension pneumatique
118) Modèle special, super volume; 1 S-10099, S-10365, S-10803, S-11011 2 S-10111, S-10112, S-97024, S-97025
119) Ch.7980
120) Ch.7981-
121) Ch.-3404
122) Ch.3405-7980
123) Ch.-5256
124) Ch.5257-
125) B 6F
126) B 6FA
127) Ch.865-.Sans ch. 873-875, lubrification à l'huile
128) B 6F, B 609, B 610
129) B 6FA, ch.-404, Hub 6772232
130) B 6FA, ch.405-
131) Ch.20000-
132) Ch.-10521. Lubrification à la graisse
133) Ch.10522-.Lubrification à l'huile
134) Lubrification à la graisse, et direction arrière
135) Lubrification à l'huile, et direction arrière. ABS/Sauf-ABS
136) Lubrification à l'huile
137) Ch.-3906
138) Ch.3907-
139) Ch.4308-ABS
140) Avec FAT 5,0
141) CHID -B169140 Moyeu disque, diam. repart. boulons. 335 mm.
142) Sauf ABS. Moyeu disque, diam. repart. boulons. 335 mm
143) Hub 6774825. Avec FAT 4,7
144) CHID -B170985
145) CHID B170986-
146) S-60677, S-60936
147) Moyeu disque, diam. repart. boulons. 335 mm, avec suspension pneumatique
148) Moyeu disque, diam. repart. boulons. 335 mm, BAT 11.5 avec suspension a lames
149) 6X2 TAG (HENDRICKSON
150) Hub 6774825,6795568
151) Modèle spécial; S-60945, S-60990, S-60993, S-61208, S-61230
152) B 6FA, ch.-404. (Erzt. 6772232, 6770991, 6771541, 960234, 6772691, 95678, 18665. One pcs of each
153) ABS/Sauf ABS. Ch.5000-
154) Ch.5000-
155) CHID. -A 276505, -B 190367, -563621
156) BAT 10.0, BAT 10.9, BAT 11.2
157) BAT 11.5, BLF-B BAT 13.0
158) BAT 11.5 LUF-B
159) FAT 4.7
160) WTT-D275
161) Ch.-A286102, -B207062, D120498

Come utilizzare il catalogo









Contenuto dei kit

	A	B	C	D	E	F	G	H	I	J	K	L			
VKA 4004							1		1				VOLVO	●	○
VKA 4026							1		1				VOLVO		○
VKA 4036							2	1					SCANIA		○
VKA 4038							1	1					SCANIA		○
VKA 4094							2	1					MERCEDES-BENZ	●	○
VKA 4095							1	2					MERCEDES-BENZ	●	○

											
A	B	C	D	E	F	G	H	I	J	K	L
Cuscinetto	Rondella di sicurezza	Dado	Distanziale	Anelli di bloccaggio	Anello seeger	Paraolio	Guarnizione	O-ring	Anello di usura	Coppiglia	Varie

VKBA = VKHB + VKHB + VKA/VKS

						
VKBA 5025 VKBA 5026		VKHB 2056 VKHB 2059	VKHB 2057 VKHB 2007	VKS 6290		

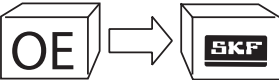
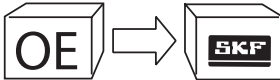
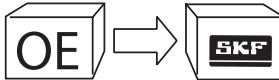

Lista di corrispondenza dal costruttore - SKF

		
BPW 02.5664.26.57 02.5664.46.57 02.5664.55.57	VKS 6285 VKS 6287 VKS 6250 VKS 6251	0174592 0174595 0190069 0221664 0266487
	VKHB 2043 VKHB 2141 VKS 6171 VKHB 2222 VKHB 2223	FIAT / IVECO 1101597 1102042
		VKHB 2060 VKHB 2282 VKHB 2283

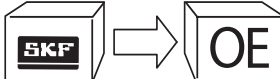
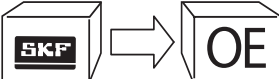



SKF - Lista di corrispondenza dal costruttore

	
VKBA 519 VKBA 523 VKBA 528	VW VW FORD FORD MERCEDES BENZ
211 498 071 211 498 071 BS 5 007 029 5 007 028 116 320 00 51	VKBA 3616
	RENAULT / RVI OPEL OPEL OPEL
	77 01 206 742 44 08 669 91160087 77 01 206 848 11 00 00 00

Cuscinetto - SKF VKHB

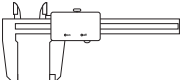
		
07087 X/K-07210 X 100 300 000	VKHB 2238 VKHB 2268 VKHB 2269	32310 TN9 32311 12
	VKHB 2303 VKHB 2304	32500/39520/Q 32500/39520/Q
		VKHB 2175 VKHB 2176

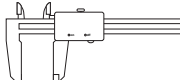
Ricerca per dimensioni (guarnizione)

					
d	D	W	d	D	W
44,0 53,0	85,0 97,0	10,0/8,0 8,0 13,0	VKS 6229 VKS 6219	117,4 118,0	142,8 12,7 27,0
			VKS 6108 VKS 6109		







Simboli

Simboli per le sezioni del catalogo

	Nuovi kit		VKBA=VKHB+VKHB+VKA/VKS
	Applicazioni, autocarri		Lista di corrispondenza dal costruttore - SKF
	Applicazioni, bus		SKF - Lista di corrispondenza dal costruttore
	Applicazioni, rimorchi e semi-rimorchi		Cuscinetto - SKF VKHB
	Lista composizione		Ricerca per dimensioni (guarnizione)

Simboli universali

	Fino a
	A partire da
	Sostituzioni
	Kit annullati
	Attrezzature

Abbreviazioni

Ch.	Numero di telaio
Forward rear axle	Ponte intermedio
Rear rear axle	Ponte posteriore
Trailing axle	Assale folle

VKBA XXXX	In produzione
VKHB XXXX	In produzione
VKA XXXX	In produzione
VKS XXXX	In produzione
VKN XXX	In produzione

Osservazioni

BPW

- 1) Telaio abbassato
- 2) Senza telaio abbassato

CITROËN

- 1) 09/81 - 12/89, Ch.-604496
- 2) 01/89 - 03/04, Ch.604497 -
- 3) 02/91 - 03/94
- 4) 01/87 - 12/89, Ch.-604496
- 5) 01/89 - 02/94, Ch. 604497 -
- 6) 09/81 - 12/86, ruota sinistra, Ch.-289710, carico utile : 1000, 1300 Kg
- 7) 09/81 - 12/86, ruota destra, Ch.-289710, carico utile : 1000, 1300 Kg
- 8) 09/81 - 03/94, ruota sinistra, carico utile :1800 Kg
- 9) 09/81 - 03/94, ruota destra, carico utile : 1800 Kg
- 10) 01/86 - 03/94, ruota sinistra, Ch.289711-, carico utile : 1000, 1300, 1400 Kg
- 11) 01/86 - 03/94, ruota destra, Ch.289711-, carico utile : 1000, 1300, 1400 Kg
- 12) 01/87 - 02/94,
- 13) 02/94 - 04/02, Ch.-16194399, carico utile :1000, 1400 Kg
- 14) 02/94 - 04/02, Ch.-16194399, carico utile : 1800 Kg
- 15) 02/94 - 04/02, Ch.16194400 -, carico utile : 1000, 1400 Kg
- 16) 02/94 - 04/02, Ch.16194400 -, carico utile : 1800 Kg
- 17) 04/02 - 09/04, carico utile : 1000, 1400 Kg
- 18) 04/02 - 09/04, carico utile : 1800 Kg
- 19) 03/94 - 04/02, Ch.-16194399, carico utile : 1000, 1400 Kg
- 20) 03/94 - 04/02, Ch.-16194399, carico utile : 1800 Kg
- 21) 03/94 - 04/02, Ch.16194400 -, carico utile : 1000, 1400 Kg
- 22) 03/94 - 04/02, Ch.16194400 -, carico utile : 1800 Kg
- 23) 08/96 - 04/02, Ch.-16194399, carico utile : 1000, 1400 Kg
- 24) 08/96 - 04/02, Ch.-16194399, carico utile : 1800 Kg
- 25) 08/96 - 04/02, Ch.16194400 -, carico utile : 1000, 1400 Kg
- 26) 08/96 - 04/02, Ch.16194400 -, carico utile : 1800 Kg
- 27) 02/94 - 04/02, Ch.16194400 -
- 28) Freni a tamburo
- 29) Freni a disco

DAF

- 2) Ruota gemellata
- 3) Carreggiata 1718 mm e mozzo a 10 bulloni
- 4) Carreggiata 1655 mm e mozzo a 8 bulloni
- 5) Eccetto centraggio sul mozzo
- 6) Con centraggio sul mozzo
- 7) Con centraggio sul mozzo. Paraolio nero
- 8) Con centraggio sul mozzo. Paraolio blu
- 9) Con riduzione mozzo
- 10) Senza FAR

- 11) Con FAR
- 12) Senza FA, FT
- 13) Con FA, FT
- 14) Eccetto centraggio sul mozzo. Paraolio nero
- 15) Eccetto centraggio sul mozzo. Paraolio blu
- 16) Paraolio nero
- 17) Paraolio blu
- 18) 1983-85
- 19) Ch. 237886-, escluso ruota gemellata
- 21) 1984-85
- 22) 1985-89
- 23) -12/89
- 24) Paraolio/ABS, separato

FIAT-IVECO

- 4) Ruota sinistra
- 5) Ruota destra
- 8) Ruota sinistra, 06/79-06/81
- 9) Ruota destra, 06/79-06/81
- 10) 10/77-06/81
- 11) Ruota sinistra, 06/81-09/84
- 12) Ruota destra, 06/81-09/84
- 13) 06/81-09/84
- 14) Ruota sinistra, 10/84-88
- 15) Ruota destra, 10/84-88
- 16) 10/84-88
- 17) 03/85-88
- 18) Ch.-604496, 1982-89
- 19) Ch.604497-, 1989-93
- 20) Ruota sinistra, Ch.-278757, 1982-86
- 21) Ruota destra, Ch.-278757, 1982-86
- 22) Ruota sinistra, Ch.278758-, 1986-93
- 23) Ruota destra, Ch.278758-, 1986-93
- 24) 1982-86
- 25) Ch.-604496, 1986-89
- 26) Ruota sinistra, 1986-93
- 27) Ruota destra, 1986-93
- 28) 10/77-12/86
- 29) 01/87-
- 30) Eccetto 50-9 D, 50-9 V
- 31) 04/91-04/92
- 32) 01/85-
- 33) Freni a Disco
- 34) 12/85-
- 36) 1991-94
- 37) Ruota sinistra, 1991-94
- 38) Ruota destra, 1991-94
- 39) Senza ABS
- 40) Escluso modelli per la Svizzera
- 41) Modelli per la Svizzera
- 42) Rapporto 4.23/1
- 43) Escluso rapporto 4.23/1
- 44) Rapporto 4.23/1. Escluso modelli per la Svizzera
- 45) Escluso rapporto 4.23/1. Escluso modelli per la Svizzera

- 46) Escluso rapporto 3.79/1
- 47) Rapporto 3.79/1
- 48) Ch.-173788
- 49) Ch.173789-. Asse -1824487
- 50) Ch.173789-. Asse 1824488-
- 51) Ch.173789-
- 52) Cuscinetto interno foro 95 mm
- 53) Cuscinetto interno foro 105 mm. Asse -1824487

- 54) Cuscinetto interno foro 105 mm. Asse 1824488-
- 55) Asse sterzante. Asse fisso, parte di ricambio 7177196
- 56) Asse fisso, parte di ricambio 7177168
- 57) Cuscinetto interno foro 100 mm
- 58) Asse -1824487
- 59) Asse 1824488-
- 60) Ruota sinistra, 06/79-01/97
- 61) Ruota destra, 06/79-01/97
- 62) 06/81-01/97
- 63) Ruota sinistra, 06/81-88
- 64) Ruota destra, 06/81-88
- 65) Escluso rapporto 5.22/1. -02/96
- 66) Rapporto 5.22/1. -02/96
- 67) Ruota sinistra, 06/79-02/96
- 68) Ruota destra, 06/79-02/96
- 69) 10/77-09/84
- 70) Senza "Iveco check control"
- 71) "Iveco check control"
- 72) Ruota sinistra, -02/96
- 73) Ruota destra, 02/96
- 74) -02/96
- 75) Rapporto 5.62/1
- 76) Escluso rapporto 5.62/1
- 77) ABS
- 78) Ruota sinistra, 03/85-88
- 79) Ruota destra, 03/85-88
- 81) -02/96
- 82) 03/96-
- 83) 1994-
- 84) 1996-
- 85) Cuscinetto ad una corona di rulli conici
- 86) Cuscinetto a 2 corone di rulli conici
- 87) Asse fisso
- 88) Asse sterzante
- 89) Trazione anteriore
- 90) Trazione posteriore
- 91) Ruota sinistra, cuscinetto ad una corona di rulli conici, 03/96 - 12/99
- 92) Ruota destra, cuscinetto ad una corona di rulli conici, 03/96 - 12/99
- 93) Cuscinetto a 2 corone di rulli conici, 03/96 - 12/99
- 94) Up to 05/89
- 95) 06/89 - 01/97
- 96) 01/96 - 12/99
- 97) Up to 12/99
- 98) 05/99 - 08/03
- 99) 06/81 - 01/97
- 100) 04/02 - 01/04
- 101) 07/02 - 01/04
- 102) Carico utile 1100, 1500 Kg
- 103) Carico utile 1800 Kg

FORD

- 1) 1965-91
- 2) 07/74-12/77
- 3) 08/65-12/77
- 6) 11/73-12/77
- 7) 01/78-10/85
- 8) Ruota sinistra, 11/85-91
- 9) Ruota destra, 11/85-91
- 10) 11/85-91
- 11) 1992-97
- 12) 01/81-03/87



Osservazioni

- 13) 03/87-12/92
- 14) 04/82 - 09/87
- 15) 10/87 - 12/90 Ruota sinistra
- 16) 10/87 - 12/90 Ruota destra
- 18) 01/00 - 10/04
- 19) 01/00 - 10/04, senza ABS, carico utile 1000 Kg, trazione anteriore
- 20) 01/00 - 10/04, ABS, carico utile 1000 Kg, trazione anteriore
- 21) 07/03 - 10/04, senza ABS, carico utile 2000 Kg, trazione anteriore
- 22) 07/03 - 10/04, ABS, carico utile 2000 Kg, trazione anteriore
- 23) 01/00 - 10/04, ruota singola, trazione posteriore
- 24) 01/00 - 10/04, doppia ruota, trazione posteriore
- 25) 03/04 - 10/04, senza ABS, carico utile 2000 Kg
- 26) 03/04 - 10/04, ABS, carico utile 2000 Kg

GIGANT (SAE)

- 1) Air suspension Type N
- 2) Ponte Protec

FRUEHAUF

- 1) Assale 107, 6 mm, freni C/C2
- 2) Assale 110 mm, freni D1/K1/H1
- 3) Assale 110 mm, freni C1/C2/L1/L2 (100 denti)
- 4) Assale 110 mm, freni C3/C5 (80 denti)

MAN

- 1) -11/93
- 2) 12/93-
- 3) W25/86-W27/90
- 4) W28/90-
- 5) Senza ABS
- 6) ABS
- 7) 01/90-
- 8) Mozzo 81.35701.0081
- 9) Mozzo 81.35701.0127
- 10) 20" TRILEX
- 11) Mozzo. 81.35701.0141
- 12) Senza "TRILEX"
- 13) "TRILEX"
- 14) -W18/94
- 15) W19/94-
- 16) -W27/96
- 17) W28/96-, mozzo 19.5"
- 18) W28/96-, mozzo 20/22.5"

MERCEDES-BENZ

- 1) 02/88 - 02/96
- 2) 02/88 - 02/96, Ch.-128165
- 3) 1983-94
- 4) Ch.-48630
- 5) Ch.48631-

- 6) Motori Diesel ch.-17768, Motori a benzina ch.-1288
- 7) Motori Diesel ch.17768-78114, motori a benzina ch. 1289 - 4706
- 8) Motori Diesel ch.78115-, Motori a benzina ch.4707-
- 9) Cuscinetto interno foro 55 mm
- 10) Assale -1358880
- 11) Assale 1358881-
- 12) 02/88 - 02/96, Ch.128166-
- 13) Assale -1278813
- 14) Assale 1278814-
- 15) 02/88 - 05/92, Pickup
- 16) 02/73 - 12/77
- 17) 01/95 - 05/02, fino a assale: S213915/Y245976
- 18) 01/95 - 05/02
- 19) Assale -1390839
- 20) Assale 1390840-
- 21) Assale -1278313
- 22) Assale 1278314-
- 23) 02/95 - 07/04, fino a assale: S213915/Y245976
- 24) Freni a tamburo
- 25) ABS, Assale -021298
- 26) ABS, Assale 021299-
- 27) Assale -724723
- 28) Assale 724724-
- 29) Mozzo 3553564401
- 30) Mozzo 3463563001
- 31) 02/95 - 07/04
- 32) 02/96 - 05/02, fino a assale: S213915/Y245976
- 33) 02/96 - 05/02
- 34) 09/96 - 07/04
- 35) 02/96 - 07/04
- 37) Mozzo 668 356 01 01, 668 356 02 01
- 38) Mozzo 972 356 01 01
- 39) Mozzo 976 356 11 01
- 40) Mozzo 678 356 04 01
- 41) Mozzo 675 356 01 01
- 42) Freni a disco
- 43) Mozzo 942 334 08 01
- 44) Mozzo 942 334 07 01, 949 334 05 01

MERITOR (ROR)

- 1) Lubrificazione

MONTENEGRO

- 1) Assale: 061001243, 061001243 A
- 2) Assale: 06-1-1068
- 3) Assale: 06-1-1176, 061001231
- 4) Assale: 061001271
- 5) Assale: 061001231 A
- 6) Assale: 061001230, 061001230 A
- 7) Assale: 06-1-1025
- 8) Assale: 061001170 A
- 9) Assale: 061001299
- 10) Assale: 061001210, 061001210 B, 061001295
- 11) Assale: 06-1-1103, 06-1-1170
- 12) Assale: 06-1-1100, 06-1-1102, 06-1-1106, 06-1-1108, 06-1-1173, 06-1-1174

OPEL

- 1) 09/00 - 10/01, ruota:15", Ch.-B 000010, code del motore :F9Q-770
- 2) 09/00 - 10/01, ruota:15", Ch. B 000011-, code del motore: F9Q-770
- 3) 07/98 - 10/01, ruota:16"
- 4) 07/98 - 10/01, pickup, ruota:15", Ch.-B 0000514, B 006055, code del motore: S8U-702
- 5) 07/98 - 10/01, autocarri leggeri, bus, Dumpertruck, ruota: 15", Ch.-B 051615, code del motore: S9W-702
- 6) 07/98 - 10/01, pickup, ruota:15", Ch.B 0000515-, B 006056-, code del motor: S8U-702
- 7) 07/98 - 10/01, autocarri leggeri, bus, Dumpertruck, ruota:15", Ch.B 051616-, code del motore:S9W-702
- 8) 07/98 - 10/01, ruota:15"
- 9) 07/98 - 10/01,ruota:16"
- 10) 08/01 - 08/05, senza ABS, Ch.- 3V613233
- 11) 08/01 - 08/05, ABS, Ch.- 3V613233
- 13) 08/01 - 08/05,

PEUGEOT

- 1) 01/83 - 11/88
- 2) 10/90 - 01/01
- 3) 09/81 - 12/89, Ch.-604496
- 4) 01/89 - 09/90, Ch.604497-
- 5) 09/81 - 12/85, ruota sinistra, carico utile 1000 Kg, 1300 Kg, Ch.-244300
- 6) 09/81 - 01/01, ruota sinistra, carico utile 1400 Kg
- 7) 09/81 - 01/01, ruota sinistra, carico utile 1800 Kg
- 8) 09/81 - 01/01, ruota destra, carico utile 1400 Kg
- 9) 09/81 - 01/01, ruota destra, carico utile 1800 Kg
- 10) 01/86 - 11/88, ruota sinistra, carico utile 1000 Kg, 1300 Kg, Ch. 244301-
- 11) 09/81 - 12/85, ruota destra, carico utile 1000 Kg, 1300 Kg, Ch.-244300
- 12) 01/86 - 11/88, ruota destra, carico utile 1000 Kg, 1300 Kg, Ch.244301-
- 13) 10/90 - 01/01, ruota sinistra, carico utile 1000 Kg, 1300 Kg
- 14) 10/90 - 01/01, ruota destra, carico utile 1000 Kg, 1300 Kg
- 15) 1967-09/70
- 16) 10/70-80
- 17) 1967-80
- 18) 1980-88
- 19) 03/94 - 04/02, carico utile 1000 Kg, 1400 Kg, Ch.-16194399
- 20) 03/94 - 04/02, carico utile 1800 Kg, Ch.-16194399
- 21) 03/94 - 04/02, carico utile 1000 Kg, 1400 Kg, Ch.16194400-
- 22) 03/94 - 04/02, carico utile 1800 Kg, Ch.16194400-
- 23) 04/02 - 07/04, carico utile 1000 Kg, 1400 Kg
- 24) 04/02 - 07/04, carico utile 1800 Kg
- 25) 07/96 - 04/02, carico utile 1000 Kg, 1400 Kg, Ch.-16194399

Osservazioni

- 26) 07/96 - 04/02, carico utile 1800 Kg, Ch.-16194399
 27) 07/96 - 04/02, carico utile 1000 Kg, 1400 Kg, Ch.16194400-
 28) 07/96 - 04/02, carico utile 1800 Kg, Ch.16194400-
 29) 03/04 - 04/02, Ch.16194400-
 30) 04/02 - 07/04
 31) 10/01 - 04/02
 32) 11/00 - 09/01, carico utile 1000 Kg, 1400 Kg
 33) 11/00 - 09/01, carico utile 1800 Kg
 34) 07/96 - 04/02, freni a tamburo
 35) 07/96 - 04/02, freni a disco
 36) 01/86 - 01/01, ruota sinestra, carico utile 1000 Kg, 1300 Kg, Ch.244301-
 37) 01/86 - 01/01, ruota destra, carico utile 1000 Kg, 1300 Kg, Ch.244301-
- RVI**
- 12) -14/06/85
 13) 17/06/85-
 14) -12/82
 15) 01/83-
 16) -15/11/85
 17) 18/11/85-
 18) -1986
 19) 1987-
 22) 07/86-
 23) -14/03/84
 24) 15/03/84-
 25) 10/84-01/86
 26) 02/86-
 27) -09/84
 28) -01/86
 29) 10/84-
 30) -09/83
 31) 10/83-
 33) -08/79
 34) 09/79-
 35) -08/84 MOT 62030
 36) -12/83
 37) 01/84-
 38) -12/85
 39) 01/86-
 40) 12/92-
 41) -05/91
 42) 06/91-03/93
 43) 04/93-
 44) -08/84 MOT 62030. -N 1539
 45) -08/84 MOT 62030. N 1540-
 47) 09/93-
 48) Senza ABS. -08/91
 49) ABS. -08/91
 50) 09/91-03/93
 51) 09/91-
 52) -03/93
 53) -08/91
 54) -07/90
 55) 08/90-
 56) -02/91
 57) 03/91-
 58) -09/90
 59) -02/92
 60) 03/92-
 61) -05/95
 62) 06/95-
- 63) Freni a tamburo
 64) Freni a disco
 65) -02/85
 66) 03/85-
 67) -17/11/93
 68) 18/11/93-
 69) 10/87-
 70) ABS
 71) -12/92
 72) 01/93-
 73) 01/77-14/03/84
 74) 03/86-
 75) Senza ABS. -08/91 senza "Trilex"
 76) ABS. -08/91. Senza "Trilex"
 77) "Trilex" 20".-03/93.
 78) "Trilex" 24".-03/93.
 79) 09/91-03/93. Senza "Trilex"
 80) -02/86
 81) -12/87
 82) Dado M75. -05/91
 83) Dado M70. -05/91
 84) Senza-ABS
 85) ABS
 86) -05/95
 87) 06/95-
 88) -03/89
 89) 04/89-
 90) 1973-1989
 91) Escluso motori G9T
 92) Con motori G9T
 96) 03/89 - 04/89, autocarri leggeri, bus, cuscinetto interno 35x72x24,5 mm
 97) 03/89 - 04/89, autocarri leggeri, bus, cuscinetto interno 35x62x18,3 mm
 98) 05/89 - 10/97, pickup
 100) 03/80 - 04/89, autocarri leggeri, bus
 101) 03/80 - 04/89, pickup
 102) 18/08/98 -
 103) - 31/03/98
 104) 01/04/98 -
 105) - 27/08/98
 106) - 24/08/98
 107) - 17/08/98
 108) Ruota singola
 109) Doppia ruota
 110) 01/09/91 - 31/03/93
 111) - 11/04/2000
 112) 12/04/2000 -
 113) 03/80 - 04/89
 114) 03/80 - 12/83, autocarri leggeri, bus
 115) 03/80 - 02/89, All models
 116) 01/84 - 12/85, autocarri leggeri, bus,
 117) 01/86 - 02/89, autocarri leggeri, bus
 118) 03/89 - 04/89
 119) 05/89 - 01/01, autocarri leggeri, bus
 120) 05/89 - 01/01
 121) 05/89 - 01/01, pickup, Model type:PC
 122) 05/89 - 01/01, autocarri leggeri, bus, cuscinetto interno 35x72x24,5 mm
 123) 05/89 - 01/01, autocarri leggeri, bus, cuscinetto interno 35x62x18,3 mm
 124) 03/01 - 11/02, senza ABS
 125) 03/01 - 11/02, con ABS
 126) 11/02 - 02/04,
 127) 03/01 - 02/04
 128) 08/80 - 07/98, autocarri leggeri, bus,
 129) 09/80 - 07/98, pickup
 130) 07/98 - 03/00
 131) 03/00 - 02/02
- 132) 07/98 - 01/01
 133) 07/98 - 10/01, autocarri leggeri, bus
 134) 07/98 - 10/01, autocarri leggeri, pickup
 135) 09/00 - 02/04, autocarri leggeri, freni a tamburo
 136) 09/00 - 02/04, autocarri leggeri, freni a tamburo
 137) 09/00 - 02/04, bus, freni a tamburo
 138) 09/00 - 02/04, bus, freni a dischi
 139) 09/00 - 02/04, pickup, freni a tamburo
 140) 09/00 - 02/04, pickup, freni a disco
 141) 07/98 - 01/01, autocarri leggeri, freni a tamburo
 142) 07/98 - 01/01, autocarri leggeri, freni a disco
 143) 10/01 - 02/04, autocarri leggeri, freni a tamburo
 144) 10/01 - 02/04, autocarri leggeri, freni a disco
 145) 07/98 - 01/01, bus, freni a tamburo
 146) 07/98 - 01/01, bus, freni a disco
 147) 10/01 - 02/04, bus, freni a tamburo
 148) 10/01 - 02/04, bus, freni a disco
 149) 07/98 - 01/01, pickup, freni a tamburo
 150) 07/98 - 01/01, pickup, freni a disco
 151) 10/01 - 02/04, pickup, freni a tamburo
 152) 10/01 - 02/04, pickup, freni a disco
 153) 07/98 - 10/01, autocarri leggeri, freni a tamburo
 154) 07/98 - 10/01, autocarri leggeri, freni a disco
 155) 07/98 - 10/01, pickup, freni a tamburo
 156) 07/98 - 10/01, pickup, freni a disco
 157) 10/03 - 02/04, autocarri leggeri, freni a tamburo
 158) 10/03 - 02/04, autocarri leggeri, freni a disco
 159) 10/03 - 02/04, bus, freni a tamburo
 160) 10/03 - 02/04, bus, freni a disco
 161) 10/03 - 02/04, pickup, freni a tamburo
 162) 10/03 - 02/04, pickup, freni a disco
- SCANIA**
- 1) Ch.-1032241
 2) Ch.1032242
 3) Ruote a disco, ch.-1032241
 4) Ruote a disco, ch.1032242-
 5) Ruote a razze
 6) Ruote a disco, ch.-1097602 SSS, ch.-4246024 SN
 7) Ruote a disco, ch.1097603 SSS-, ch.4246025 SN-
 8) Ruote a razze, ch.-1105665 SSS, ch.-4238514 SN
 9) Ruote a razze, ch.1105666 SSS-, ch.4238515 SN-
 10) Ruote a disco
 11) Ruote a razze. Larghezza telaio 2300 mm
 12) Ruote a razze. Mozzo 20" o 22.5", ch.-1103187 SSS, ch. -4248317 SN
 13) Ruote a razze. Mozzo 20" o 22.5", ch.1103188 SSS-, ch. 4248318 SN-
 Ruote a razze. Mozzo 24"
 14) Ch.-1097602 SSS, ch.-4246024 SN
 15) Ch.-1097603 SSS-, ch.4246025 SN-
 16) Ruote a disco, ch.-1033747
 17) Ruote a disco, ch.1033748-
 18) Ruote a razze. Mozzo 20" o 22", ch.-1103187 SSS, ch. -4248317 SN
 19) Ruote a disco, ch.1033748-



Osservazioni

- 20) Ruote a razze. Mozzo 20" o 22", -ch.1103188 SSS-, ch. 4248318 SN-
- 21) Ruote a disco, ruote a razze
- 22) Ruote a disco (4x2, 6x2, 6x4)
- 23) Ruote a razze (4x2, 6x2, 6x4). Mozzo 20" o 22.5"
- 24) Ruote a razze. Mozzo 24". Ganasce freno 178 mm
- 25) Ruote a razze. Mozzo 24". Ganasce freno 203 mm
- 26) Doppio assale sterzante
- 27) Ruote a razze. Mozzo 20", 22.5" o 24"
- 28) Senza riduzione mozzo
- 29) Con riduzione mozzo
- 30) Ruote a disco, ch.-1029858
- 31) Ruote a disco, ch.1029859-
- 32) Ruote a disco, ruote a razze. Mozzo 24"
- 33) Ruote a disco, ruote a razza. Mozzo 20" o 22.5"
- 34) Ruote a disco, ruote a razze. Mozzo 20", 22" o 24"
- 35) Ruote a disco, ch.-1161721 SSS, ch.-4292924 SN
- 36) Ruote a disco, ch.1161722 SSS-, ch.4292925 SN-
- 37) Ruote a disco, ruote a razze. Mozzo 24". ch.-1180029 SSS
- 38) Ruote a disco, ruote a razze. Mozzo 24" ch.1180030 SSS-
- 39) Ruote a disco, ch.-1850412
- 40) Ruote a disco, ch.1850413-
- 41) Sospensione a balestra. ch.-1801229
- 42) Sospensione a balestra. ch.1801230-
- 43) Sospensione a gas, ch.-1802872
- 44) Sospensione a gas, ch.1802873-
- 45) Ch.-1801229
- 46) Ch.1801230-
- 47) Ruote a disco. ABS/Senza ABS
- 48) ABS/Senza ABS
- 49) Sospensione a gas
- 50) Sospensione a gas/ABS
- 51) Sospensione a gas. Sospensione a Trapeze
- 52) Sospensione a gas. Sospensione a Trapeze. ABS
- 53) Ruote a disco, ch.-1871409
- 54) Ch.1871410-1871595
- 55) Ch.1871596-
- 56) Ch.1871410-
- 57) Ganasce freno 5"
- 58) Ganasce freno 7". Ch.1801196-
- 59) Ch.-1801195
- 60) Ch.1801196-
- 61) Ch.-1808231
- 62) Ch.1808232-
- 63) ABS/Senza ABS. Ch.-1808901, Ch.1808902-
- 64) ABS/Senza ABS. Ch.-1806768, Ch.1806769-
- 65) Mozzo assale folle
- 66) Ruote a disco, ABS/Senza. Ch.-1808901, Ch.1808902-
- 67) Sospensione a gas. Mozzo 22.5"
- 68) Sospensione a gas. Mozzo 22.5". ABS
- 69) ABS
- 70) Mozzo 8.25 x 22.5"
- 71) Mozzo 8.25 x 22.5". ABS
- 72) Mozzo 9.00 x 22.5"
- 73) Mozzo 9.00 x 22.5". ABS
- 74) 6.5 tons
- 75) 6.5 tons. ABS
- 76) 7.1 tons
- 77) 7.1 tons. ABS
- 78) 6.5 tons. Ch.-1820117, ch.1820118-
- 79) 6.5 tons. Ch.-1820117. ABS
- 80) 7.1 tons. Ch.-1820117
- 81) 7.1 tons. Ch.-1820117. ABS
- 82) ABS/Senza ABS. Ch.-1820117, ch.1820118-
- 83) Sospensione a gas, ch.-1801229
- 84) Sospensione a gas, ch.1801230-1802872
- 85) Ruote a disco, Senza ABS, Ch.9015825-SAN, ch.4362206 SNL-, ch. 1226892 SSS -
- 86) Ruote a disco, ABS, Ch.9015825-SAN, Ch.4362207-SNL, ch.1226892 SSS-
- 87) Ruote a razza, ABS/Senza ABS
- 88) Ruote a disco, ABS/Senza ABS, Ch.9015825 SAN-, ch. 4362207 SNL-, ch.1226892 SSS-
- 89) Ruote a disco, Senza ABS, Ch.9015825 SAN-, ch.4362207 SNL-, ch.1226207 SSS-
- 90) Ruote a disco, Senza ABS
- 91) Ruote a disco, Senza ABS, RP/RBP730
- 92) Senza ABS, RP/RBP832
- 93) Ruote a disco, ABS
- 94) Ruote a disco/Ruote a razza, ABS/Senza ABS, Ch.9015825 SAN-, ch.4362207 SNL-, ch.1226892 SSS-
- 95) Ruote a razza, Senza ABS
- 96) Ruote a disco, Ch.1820118-, ABS
- 97) Ruote a disco, Ch.1820118-, Senza ABS
- 98) -ch. Scania Sodertalje 1242205, Scania Zwalte 4397541, Scania Angers 9034654, Scania Katrineholm 1833391
- 99) Ruote a disco, Freni a disco, ABS
- 100) Ruote a razze, Mozzo 22" o 22.5"
- 101) RP/RBP 832
- 102) Mozzo 22", 22.5 o 24"
- 103) Mozzo 20", 22.5, RBP/RP 730
- 104) Mozzo 24", RP/RBP 832
- 105) Ruote a disco, ch.-9015824 SAN, ch.-4365570 SNL, ch.-1226891 SSS
- 106) Ruote a disco, ABS, ch.-9015824 SAN, ch.-4362206 SNL, ch.-1226891 SSS
- 107) Ruote a disco, Freni a disco, ABS/Senza-ABS
- 5) Ch.28G-015892 - 21N-006785, 04/86-07/91, Anello bloccaggio di 20 mm
- 7) Ch.21N-002488 -, 08/91-96, Anello bloccaggio di 22.5 mm
- 8) Ruota gemellata 1976-96
- 9) Escluso ruota gemellata. Ch.28G-015892 - 21N-006785, anello bloccaggio di 20 mm
- 10) Escluso ruota gemellata. Ch.21N-006785 -, 08/91-96, Anello bloccaggio di 22.5 mm
- 11) Molle elicoidali, 1979-82
- 12) Balestre, ch.-28-B-018540, 1979-81
- 13) Balestre, ch.28-B-018541-, 1981-82
- 14) 1979-82
- 15) Ch.-28-B-019162, 1979-81
- 16) Ch.28-B-019163-, 1981-82
- 17) 1983-96
- 18) 3500 kg, 1983-96
- 19) 4000 kg, 1983-96
- 20) 1984-96
- 21) 1962-67
- 22) 1968-79
- 23) Ch.-24-E-023827, 1980-84
- 24) Ch.24-E-023828-, 1984-92
- 25) 1962-70
- 26) 1971-92
- 27) 10/84-92
- 28) 1993-00
- 29) 1991-00
- 30) 800-1200 kg, 1991-00
- 31) 08/85 - 07/92
- 32) 11/84 - 07/92
- 33) 08/75 - 07/92
- 34) 07/90 - 10/04
- 35) 10/92 - 10/04
- 36) 07/90 - 10/04, 800-1200 Kg
- 37) 10/92 - 10/04, 800-1200 Kg
- 38) 04/03 - 09/04, Ch.-7 H-4-017500, 7J-4-017500
- 39) 07/04 - 09/04, Ch.-7 H-4-017500, 7J-4-017500
- 40) 04/03 - 10/04
- 41) 07/04 - 10/04

SMB

- 1) Assale 107, 6 mm, freni C1/C2
- 2) Assale 110 mm, freni D1/K1/H1
- 3) Assale 110 mm, freni C1/C2/L1/L2 (100 denti)
- 4) Assale 110 mm, freni C3/C5 (80 denti)

TRAILOR

- 1) Assale 107, 6 mm, freni C1/C2
- 2) Assale 110 mm, freni D1/K1/H1
- 3) Assale 110 mm, freni C1/C2/L1/L2 (100 denti)
- 4) Assale 110 mm, freni C3/C5 (80 denti)

VOLKSWAGEN

- 1) 1976-96

VOLVO

- 1) Mozzo 363067
- 2) Perno a snodo 57 mm
- 3) Ch.-20653
- 4) Ruote a disco, ch.20654-
- 5) Ruote a razze, ch.20654-
- 6) Ruote a disco. Ruote a razze -1503875
- 7) Ruote a razze 1503876-
- 8) Senza riduzione mozzo, ch.36634-
- 9) Con riduzione mozzo
- 10) Senza riduzione mozzo
- 11) Ruote a disco
- 12) Ruote a razze
- 13) Ch.-6997
- 14) Ruote a disco, ch.6998-
- 15) Ruote a razze, ch.6998-
- 16) Balestre rigide
- 17) Balestre semi-rigide
- 18) Ch.-7050
- 19) Ch.7051-
- 20) Ch.-23510
- 21) Ch.23511-
- 22) Ch.-2376

Osservazioni

- 23) Ch.2377-
24) Ch.-6450
25) Ch.6451-
26) Ch.-703
27) Ch.704-
28) Ch.-21671
29) Ch.21672-
30) Ch.-3145 (approx.)
31) Ch.3146 (approx.)-6871
32) Ch.6872-
33) Ch.-2728
34) Ch.2729-6871
35) ABS/Senza-ABS
36) Assale semirigido
37) Per veicoli con telaio rigido
38) Per veicoli senza telaio rigido
39) Ruote con cerchione pieno, diametro attacco bulloni 335 mm
40) ABS/Senza-ABS. Ruote a disco, diametro attacco bulloni 335 mm
41) Ruote a disco, ch.-27087
42) Ruote a disco, ch.27088-
43) Ruote a razze. Mozzo 20", ch.-27087
44) Ruote a razze. Mozzo 22", ch.-27087
45) Ruote a razze, ch.27088-
46) Ruote a razze. Mozzo 20"
47) Ruote a razze. Senza riduzione mozzo
48) Ruote a disco, ch.-19745
49) Ruote a disco, ch.19746-
50) Con sospensione ad aria ed esecuzione particolare
51) Con &S-ride8 e ruote semplici
52) Ruota con cerchione pieno, vecchi modelli
53) Ruote a raggi, vecchi modelli
54) Veicoli da cantieri edili con assale diritto, e altezza dal suolo maggiorata
55) Ruote a razze. ABS/Senza-ABS
56) Ruote a disco. ABS/Senza-ABS posteriore a balestra
57) Ruote con cerchione pieno BGT 18/21/26 e con sospensione posteriore a balestra
58) Ruote a disco. &S-ride8. Con sospensione a gas e sterzo posteriore
59) Con sospensione a gas e sterzo posteriore
60) ABS/Senza-ABS, con balestre
61) Ch.-12099
62) Ch.12100-
63) Ch.12001-
64) Ruote a disco, ch.-11549
65) Ruote a disco, ch.11550-
66) Ch.-26821
67) Ch.26822-
68) Ruote a disco, ch.-40640, ABS/Senza-ABS
69) Ruote a razze. Mozzo 20", senza riduzione mozzo
70) Ruote a razze. Mozzo 24", senza riduzione mozzo
71) Ruote a disco, ch.-20876, ABS/Senza-ABS
72) Ruote a disco, ch.20877-, ABS/Senza-ABS
73) Ruote a disco, ch.25001-40640, diametro attacco bulloni 335 mm
74) Ruote a razze. Mozzo 20", ch.25001-40640
75) Ruote a razze. Mozzo 24", ch.25001-40640
76) Con sospensione a gas, ch-25000
77) Con &S-ride8 e ruote semplici, ch.25001-40640
78) Ruote a disco, con riduzione mozzo
79) Ch.-52439
80) Ch.52440-
81) Ruote a disco, diametro attacco bulloni 335 mm, ch.306000-
82) Ruote a razze. Mozzo 20" o 24", ch.306000-
83) ABS/Senza-ABS, ruote a disco, diametro attacco bulloni 335 mm, ch.306000-
84) Ruote a disco, ch.-46315
85) Ruote a disco, ch.46316-, ABS/Senza-ABS
86) Ruote a razze. Mozzo 24", ch.49001-
87) Ruote a disco. Mozzo 20", 22.5" o 24"
88) Veicoli da cantieri edili con assale, diritto
89) Ruote a razze. Mozzo 24"
90) Ch.-36763
91) Ch.36764-
92) Ch.-65820
93) Ruote a razze. Mozzo 20" o 24", ch.-65820
94) Ruote a razze. Senza riduzione mozzo
95) Ruote a disco, ch.-22914
96) Ruote a disco, ch.22915-
97) Ruote a razze. Mozzo 20", ch.34001-
98) Ruote a razze. Mozzo 24", ch.34001-
99) Con sospensione a gas
100) Modello speciale, super volyme S-10609, S-10610, S-10801, S-11010, S-97024, S-97025, ch.314000-
101) Ruote a razze. Mozzo 20" o 24"
102) Ruote a raggi, a singola riduzione
103) Doppio assale con riduzione sul mozzo
104) Ruote folle singola, a cerchione pieno
105) Ruote doppia, a cerchione pieno
106) Ch.-15169
107) Ch.15170-
108) Ruote a disco, ch.-8779
109) Ruote a disco, ch.8780-
110) Ruote a razze, ch.-12000
111) Ruote a razze. Mozzo 20", ch.12001-
112) Ruote a razze. Mozzo 24", ch.12001-
113) Ruote a razze. Mozzo 22", 22.5" o 24"
114) Ruote a razze. Mozzo 20", con balestre, ABS/Senza-ABS
115) Ruote a razze. Mozzo 24", con balestre
116) Ruote a razze. Mozzo 20", con sospensione a gas
117) Ruote a razze, ch.314000-, con sospensione a gas, posteriore
118) Modello speciale, super volyme; 1) S-10099, S-10365, S-10803, S-11011 2) S-10111, S-10112, S-97024, S-97025
119) Ch.7980
120) Ch.7981-
121) Ch.-3404
122) Ch.3405-7980
123) Ch.-5256
124) Ch.5257-
125) B 6F
126) B 6FA
127) Ch.865-.Senza ch.873-875, lubrificazione ad olio
128) B 6F, B 609, B 610
129) B 6FA, ch.-404. Mozzo 6772232
130) B 6FA, ch.405-
131) Ch.20000-
132) Ch.-10521, lubrificazione a grasso
133) Ch.10522-, lubrificazione ad olio
134) Lubrificazione a grasso e sterzo posteriore
135) Lubrificazione ad olio e sterzo posteriore, ABS/Senza-ABS
136) Lubrificazione ad olio
137) Ch.-3906
138) Ch.3907-
139) Ch.4308-. ABS
140) Con FAT 5,0
141) CHID -B169140. Ruota a disco, diametro attacco bulloni 335 mm
142) Senza ABS. Ruota a disco, diametro attacco bulloni 335 mm
143) Mozzo 6774825. Con FAT 4,7
144) CHID -B170985
145) CHID B170986-
146) S-60677, S-60936
147) Ruota a disco, diametro attacco bulloni 335 mm, con sospensione a gas
148) Ruota a disco, diametro attacco bulloni 335 mm, BAT 11,5 con balestre
149) 6X2 TAG (HENDRICKSON)
150) Mozzo 6774825,6795568
151) Modello speciale; S-60945, S-60990, S-60993, S-61208, S-
152) B 6FA, ch.-404. Mozzo 6010088
153) ABS/Senza ABS. Ch.5000-
154) Ch.5000-
155) CHID. -A 276505, -B 190367, -563621
156) BAT 10.0, BAT 10.9, BAT 11.2
157) BAT 11.5 BLF-B BAT 13.0
158) BAT 11.5 LUF-B
159) FAT 4,7
160) WTT-D275
161) Ch.-A286102, -B207062, D120498



Cómo utilizar el catálogo

Marcas y modelos

Tipo de eje de lanterno/trasero

Tipo de eje

Accessory kit

Rodamiento exterior/ Retén de aceite

Kit completo

Rodamiento interior/ Retén de aceite

Designación del rodamiento

Kit de rodamiento

Kit de retén de aceite

Observaciones

Ejemplo







Marcas y modelos	Tipo de eje de lanterno/trasero	Tipo de eje	Accessory kit	Rodamiento exterior/ Retén de aceite	Rodamiento interior/ Retén de aceite	Designación del rodamiento	Kit de rodamiento	Kit de retén de aceite	Observaciones
DAF Sherpa 285, 300, 310, 350	●	○	VKBA 5240	●	●	VKHB 2237 VKHB 2238 L 68149/110/Q 07087 X/ K-07210 X	●	●	2), 22)
Sherpa 285, 310, 350 (MT 210)	●	○	VKBA 5240	●	●	VKHB 2237 VKHB 2238 L 68149/110/Q 07087 X/ K-07210 X	●	●	2), 18)
F 400 Ser.	●	28 N	VKBA 5240	●	●	VKHB 2237 VKHB 2238 L 68149/110/Q 07087 X/ K-07210 X	●	●	

Contenido de los kits

	A	B	C	D	E	F	G	H	I	J	K	L			
VKA 4004							1		1				VOLVO	●	○
VKA 4026							1		1				VOLVO		○
VKA 4036							2	1					SCANIA		○
VKA 4038							1	1					SCANIA		○
VKA 4094							2	1					MERCEDES-BENZ	●	○
VKA 4095							1	2					MERCEDES-BENZ	●	○

A	B	C	D	E	F	G	H	I	J	K	L
Rodamientos	Arandela de retención	Tuerca	Distanciador	Anillo de reención	Anillo de fijación	Retén de aceite	Junta	Junta tórica	Placa de obturación	Pasador	Varios



VKBA = VKHB + VKHB + VKA/VKS

						
VKBA 5025 VKBA 5027		VKHB 2056 VKHB 2059	VKHB 2057 VKHB 2007	VKS 6299		

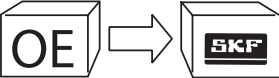
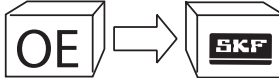
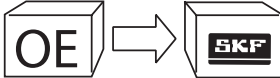

Lista de correspondencias constructores – SKF

		
BPW 02.5664.26.57 02.5664.46.57 02.5664.55.57	VKS 6285 VKS 6287 VKS 6250 VKS 6251	0174592 0174595 0190069 0221664 0266487
	VKHB 2043 VKHB 2141 VKS 6171 VKHB 2222 VKHB 2223	FIAT / IVECO 1101597 1102042
		VKHB 2060 VKHB 2282 VKHB 2283





SKF – Lista de correspondencias constructores

	
VKBA 519 VKBA 523 VKBA 528	VW VW FORD FORD MERCEDES BENZ
211 498 071 211 498 071 BS 5 007 029 5 007 028 116 320 00 51	VKBA 3616
	RENAULT / RVI OPEL OPEL OPEL
	77 01 206 742 44 08 669 91160087 77 01 206 848 1102042

Rodamientos - SKF VKHB

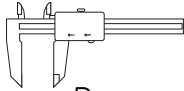
		
07087 X/K-07210 X 100 300 100	VKHB 2238 VKHB 2268 VKHB 2269	32310 TN9 32311 12
	VKHB 2303 VKHB 2304	30500/39520/Q
		VKHB 2175 VKHB 2176

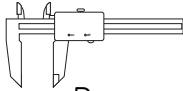
Búsqueda por dimensiones (retenes)

					
d	D	W	d	D	W
44,0 53,0	85,0 97,0	10,0/8,0 8,0 13,0	VKS 6229 VKS 6219	117,4 118,0	142,8 12,7 27,0
					VKS 6108 VKS 6109

Símbolos

Símbolos para las secciones del catálogo



Nuevos kits



Lista de marcas y modelos, camiones



Lista de marcas y modelos, autobuses



Lista de marcas y modelos, de ejes para remolques/semi-remolques



Contenido de los kits

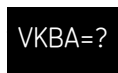

VKBA=? VKBA=VKHB+VKHB+VKA/VKS



Lista de correspondencias constructores – SKF



SKF – Lista de correspondencias constructores



Rodamientos - SKF VKHB



Búsqueda por dimensiones (retenes)

Símbolos universales

→| Hasta
|→ Desde



Sustituciones



Kits anulados



Herramientas

Abreviaturas

Ch. Referencia del chasis
Forward rear axle Puento trasero anterior
Rear rear axle Puento trasero posterior
Trailing axle Eje trasero

VKBA XXXX En producción
 VKHB XXXX En producción
 VKA XXXX En producción
 VKS XXXX En producción
 VKN XXX En producción

Observaciones

BPW

- 1) Cargador bajo
- 2) Excepto cargador bajo

CITROËN

- 1) 09/81 - 12/89, Ch.-604496
- 2) 01/89 - 03/04, Ch.604497 -
- 3) 02/91 - 03/94
- 4) 01/87 - 12/89, Ch.-604496
- 5) 01/89 - 02/94, Ch. 604497 -
- 6) 09/81 - 12/86, rueda izquierda, Ch.-289710, carga útil : 1000, 1300 Kg
- 7) 09/81 - 12/86, rueda izquierda, Ch.-289710, carga útil : 1000, 1300 Kg
- 8) 09/81 - 03/94, rueda izquierda, carga útil :1800 Kg
- 9) 09/81 - 03/94, rueda izquierda, carga útil : 1800 Kg
- 10) 01/86 - 03/94, rueda izquierda, Ch.289711-, carga útil : 1000, 1300, 1400 Kg
- 11) 01/86 - 03/94, rueda izquierda, Ch.289711-, carga útil : 1000, 1300, 1400 Kg
- 12) 01/87 - 02/94,
- 13) 02/94 - 04/02, Ch.-16194399, carga útil :1000, 1400 Kg
- 14) 02/94 - 04/02, Ch.-16194399, carga útil : 1800 Kg
- 15) 02/94 - 04/02, Ch.16194400 -, carga útil : 1000, 1400 Kg
- 16) 02/94 - 04/02, Ch.16194400 -, carga útil : 1800 Kg
- 17) 04/02 - 09/04, carga útil : 1000, 1400 Kg
- 18) 04/02 - 09/04, carga útil : 1800 Kg
- 19) 03/94 - 04/02, Ch.-16194399, carga útil : 1000, 1400 Kg
- 20) 03/94 - 04/02, Ch.-16194399, carga útil : 1800 Kg
- 21) 03/94 - 04/02, Ch.16194400 -, carga útil : 1000, 1400 Kg
- 22) 03/94 - 04/02, Ch.16194400 -, carga útil : 1800 Kg
- 23) 08/96 - 04/02, Ch.-16194399, carga útil : 1000, 1400 Kg
- 24) 08/96 - 04/02, Ch.-16194399, carga útil : 1800 Kg
- 25) 08/96 - 04/02, Ch.16194400 -, carga útil : 1000, 1400 Kg
- 26) 08/96 - 04/02, Ch.16194400 -, carga útil : 1800 Kg
- 27) 02/94 - 04/02, Ch.16194400 -
- 28) Frenos de tambor
- 29) Frenos de disco

DAF

- 2) Ruera trasera doble
- 3) Ancho de via 1718 mm, con 10 pernos
- 4) Ancho de via 1655 mm, con 8 pernos
- 5) Excepto cubo centrado
- 6) Con cubo centrado
- 7) Con cubo centrado. Réten de aceite, negro
- 8) Con cubo centrado. Réten de aceite, azul
- 9) Con cubo reductor
- 10) Excepto FAR

- 11) Con FAR
- 12) Excepto FA, FT
- 13) Con FA, FT
- 14) Excepto cubo centrado. Réten de aceite, negro
- 15) Excepto cubo centrado. Réten de aceite, azul
- 16) Réten de aceite, negro
- 17) Réten de aceite, azul
- 18) 1983-85
- 19) Ch. 237886-, excepto rueda gemela
- 21) 1984-85
- 22) 1985-12/89
- 23) -12/89
- 24)

FIAT-IVECO

- 4) Rueda izquierda
- 5) Rueda derecha
- 8) Rueda izquierda, 06/79-06/81
- 9) Rueda derecha, 06/79-06/81
- 10) 10/77-06/81
- 11) Rueda izquierda, 06/81-09/84
- 12) Rueda derecha, 06/81-09/84
- 13) 06/81-09/84
- 14) Rueda izquierda, 10/84-88
- 15) Rueda derecha, 10/84-88
- 16) 10/84-88
- 17) 03/85-88
- 18) Ch.-604496, 1982-89
- 19) Ch.604497-, 1989-93
- 20) Rueda izquierda, ch.-278757, 1982-86
- 21) Rueda derecha, ch.-278757, 1982-86
- 22) Rueda izquierda, ch.278758-, 1986-93
- 23) Rueda derecha, ch.278758-, 1986-93
- 24) 1982-86
- 25) Ch.-604496, 1986-89
- 26) Rueda izquierda, 1986-93
- 27) Rueda derecha, 1986-93
- 28) 10/77-12/86
- 29) 01/87-
- 30) Excepto 50-9 D, 50-9 V
- 31) 04/91-04/92
- 32) 01/85-
- 33) Frenos de disco
- 34) 12/85-
- 36) 1991-94
- 37) Rueda izquierda, 1991-94
- 38) Rueda derecha, 1991-94
- 39) Excepto ABS
- 40) Excepto modelos para Suiza
- 41) Modelos para Suiza
- 42) Relación 4.23/1
- 43) Excepto relación 4.23/1
- 44) Relación 4.23/1. Excepto modelos para Suiza
- 45) Excepto relación 4.23/1. Excepto modelos para Suiza

- 46) Excepto relación 3.79/1

- 47) Relación 3.79/1
- 48) Ch.-173788
- 49) Ch.173789-. Eje -1824487
- 50) Ch.173789-. Eje 1824488-
- 51) Ch.173789-
- 52) Rodamiento interior de 95 mm de diámetro interior.
- 53) Rodamiento interior de 105 mm de diámetro interior. Eje -1824487

- 54) Rodamiento interior de 105 mm de diámetro interior. Eje 1824488-
- 55) Eje de dirección. Eje rígido, pieza de recambio 7177196
- 56) Eje rígido, pieza de recambio 7177168
- 57) Rodamiento interior de 100 mm de diámetro interior
- 58) Eje -1824487
- 59) Eje 1824488-
- 60) Rueda izquierda, 06/79-01/97
- 61) Rueda derecha, 06/79-01/97
- 62) 06/81-01/97
- 63) Rueda izquierda, 06/81-88
- 64) Rueda derecha, 06/81-88
- 65) Excepto relación 5.22/1. -02/96
- 66) Relación 5.22/1. -02/96
- 67) Rueda izquierda, 06/79-02/96
- 68) Rueda derecha, 06/79-02/96
- 69) 10/77-09/84
- 70) Excepto "Iveco check control"
- 71) "Iveco check control"
- 72) Rueda izquierda, -02/96
- 73) Rueda derecha, 02/96
- 74) -02/96
- 75) Relación 5.62/1
- 76) Excepto relación 5.62/1
- 77) ABS
- 78) Rueda izquierda, 03/85-88
- 79) Rueda derecha, 03/85-88
- 81) -02/96
- 82) 03/96-
- 83) 1994-
- 84) 1996-
- 85) Rodamientos de rodillos cónicos, 1 hilera
- 86) Rodamientos de rodillos cónicos, 2 hileras
- 87) Eje rígido
- 88) Eje de dirección
- 89) Tracción delantera
- 90) Tracción trasera
- 91) Rueda izquierda, rodamientos de rodillos cónicos, 1 hilera, 03/96 - 12/99
- 92) Rueda derecha, rodamientos de rodillos cónicos, 1 hilera, 03/96 - 12/99
- 93) Rodamientos de rodillos cónicos, 2 hileras, 03/96 - 12/99
- 94) Up to 05/89
- 95) 06/89 - 01/97
- 96) 01/96 - 12/99
- 97) Up to 12/99
- 98) 05/99 - 08/03
- 99) 06/81 - 01/97
- 100) 04/02 - 01/04
- 101) 07/02 - 01/04
- 102) Carga útil 1100, 1500 Kg
- 103) Carga útil 1800 Kg

FORD

- 1) 1965-91
- 2) 07/74-12/77
- 3) 08/65-12/77
- 6) 11/73-12/77
- 7) 01/78-10/85
- 8) Rueda izquierda, 11/85-91
- 9) Rueda derecha, 11/85-91
- 10) 11/85-91
- 11) 1992-97

Observaciones

- 12) 01/81-03/87
- 13) 03/87-12/92
- 14) 04/82 - 09/87
- 15) 10/87 - 12/90 Rueda izquierda
- 16) 10/87 - 12/90, Rueda derecha
- 18) 01/00 - 10/04
- 19) 01/00 - 10/04, excepto ABS, carga útil 1000 Kg, tracción delantera
- 20) 01/00 - 10/04, ABS, carga útil 1000 Kg, tracción delantera
- 21) 07/03 - 10/04, excepto ABS, carga útil 2000 Kg, tracción delantera
- 22) 07/03 - 10/04, ABS, carga útil 2000 Kg, tracción delantera
- 23) 01/00 - 10/04, rueda simple, tracción trasera
- 24) 01/00 - 10/04, ruedas gemelas, Tracción trasera
- 25) 03/04 - 10/04, excepto ABS, carga útil 2000 Kg
- 26) 03/04 - 10/04, ABS, carga útil 2000 Kg

GIGANT (SAE)

- 1) Air suspension Type N
- 2) Ponte Protec

FRUEHAUF

- 1) Eje 107, 6 mm, frenos C1/C2
- 2) Eje 110 mm, frenos D1/K1/H1
- 3) Eje 110 mm, frenos C1/C2/L1/L2 (100 dientes)
- 4) Eje 110 mm, frenos C3/C5 (80 dientes)

MAN

- 1) -11/93
- 2) 12/93-
- 3) W25/86-W27/90
- 4) W28/90-
- 5) Excepto ABS
- 6) ABS
- 7) 01/90-
- 8) Cubo 81.35701.0081
- 9) Cubo 81.35701.0127
- 10) 20" TRILEX
- 11) Cubo 81.35701.0141
- 12) Excepto "TRILEX"
- 13) "TRILEX"
- 14) -W18/94
- 15) W19/94-
- 16) -W27/96
- 17) W28/96-, Cubo 19,5"
- 18) W28/96-, Cubo 20/22.5"

MERCEDES-BENZ

- 1) 02/88 - 02/96
- 2) 02/88 - 02/96, Ch.-128165
- 3) 1983-94
- 4) Ch.-48630
- 5) Ch.48631-

- 6) Motor diesel ch.-17768, motor gasolina ch.-1288
- 7) Motor diesel ch.17768-78114, motor gasolina ch.1289-4706
- 8) Motor diesel ch.78115-, motor gasolina ch.4707-
- 9) Rodamiento interior de 55 mm de diámetro interior
- 10) Eje -1358880
- 11) Eje 1358881-
- 12) 02/88 - 02/96, Ch.128166-
- 13) Eje -1278813
- 14) Eje 1278814-
- 15) 02/88 - 05/92, camioneta
- 16) 02/73 - 12/77
- 17) 01/95 - 05/02, hasta eje: S213915/Y245976
- 18) 01/95 - 05/02
- 19) Eje -1390839
- 20) Eje 1390840-
- 21) Eje -1278313
- 22) Eje 1278314-
- 23) 02/95 - 07/04, hasta eje: S213915/Y245976
- 24) Frenos de tambor
- 25) ABS, Eje -021298
- 26) ABS, Eje 021299-
- 27) Eje -724723
- 28) Eje 724724-
- 29) Cubo 3553564401
- 30) Cubo 3463563001
- 31) 02/95 - 07/04
- 32) 02/96 - 05/02, hasta eje: S213915/Y245976
- 33) 02/96 - 05/02
- 34) 09/96 - 07/04
- 35) 02/96 - 07/04
- 37) Cubo: 668 356 01 01, 668 356 02 01
- 38) Cubo: 972 356 01 01
- 39) Cubo: 976 356 11 01
- 40) Cubo: 678 356 04 01
- 41) Cubo: 675 356 01 01
- 42) Frenos de disco
- 43) Cubo: 942 334 08 01
- 44) Mozza 942 334 07 01, 949 334 05 01

MERITOR (ROR)

- 1) Lubricado con grasa

MONTENEGRO

- 1) Eje: 061001243, 061001243 A
- 2) Eje: 06-1-1068
- 3) Eje: 06-1-1176, 061001231
- 4) Eje: 061001271
- 5) Eje: 061001231 A
- 6) Eje: 061001230, 061001230 A
- 7) Eje: 06-1-1025
- 8) Eje: 061001170 A
- 9) Eje: 061001299
- 10) Eje: 061001210, 061001210 B, 061001295
- 11) Eje: 06-1-1103, 06-1-1170
- 12) Eje: 06-1-1100, 06-1-1102, 06-1-1106, 06-1-1108, 06-1-1173, 06-1-1174

OPEL

- 1) 09/00 - 10/01, rueda:15", Ch.-B 000010, code del motore :F9Q-770
- 2) 09/00 - 10/01, rueda:15", Ch. B 000011-, code del motore: F9Q-770
- 3) 07/98 - 10/01, rueda:16"
- 4) 07/98 - 10/01, camioneta, rueda:15", Ch.-B 0000514, B 006055, code del motore: S8U-702
- 5) 07/98 - 10/01, vehículo industrial, autobús, Dumpertruck, rueda: 15", Ch.-B 051615, code del motore: S9W-702
- 6) 07/98 - 10/01, camioneta, rueda:15", Ch.B 0000515-, B 006056-, code del motor: S8U-702
- 7) 07/98 - 10/01, vehículo industrial, autobús, Dumpertruck, rueda:15", Ch.B 051616-, code del motore:S9W-702
- 8) 07/98 - 10/01, rueda:15"
- 9) 07/98 - 10/01, rueda:16"
- 10) 08/01 - 08/05, excepto ABS, Ch.- 3V613233
- 11) 08/01 - 08/05, ABS, Ch.- 3V613233
- 13) 08/01 - 08/05,

PEUGEOT

- 1) 01/83 - 11/88
- 2) 10/90 - 01/01
- 3) 09/81 - 12/89, Ch.-604496
- 4) 01/89 - 09/90, Ch.604497-
- 5) 09/81 - 12/85, rueda izquierda, carga útil 1000 Kg, 1300 Kg, Ch.-244300
- 6) 09/81 - 01/01, rueda izquierda, carga útil 1400 Kg
- 7) 09/81 - 01/01, rueda izquierda, carga útil 1800 Kg
- 8) 09/81 - 01/01, rueda derecha, carga útil 1400 Kg
- 9) 09/81 - 01/01, rueda derecha, carga útil 1800 Kg
- 10) 01/86 - 11/88, rueda izquierda, carga útil 1000 Kg, 1300 Kg, Ch. 244301-
- 11) 09/81 - 12/85, rueda derecha, carga útil 1000 Kg, 1300 Kg, Ch.-244300
- 12) 01/86 - 11/88, rueda derecha, carga útil 1000 Kg, 1300 Kg, Ch.244301-
- 13) 10/90 - 01/01, rueda izquierda, carga útil 1000 Kg, 1300 Kg
- 14) 10/90 - 01/01, rueda derecha, carga útil 1000 Kg, 1300 Kg
- 15) 1967-09/70
- 16) 10/70-80
- 17) 1967-80
- 18) 1980-88
- 19) 03/94 - 04/02, carga útil 1000 Kg, 1400 Kg, Ch.-16194399
- 20) 03/94 - 04/02, carga útil 1800 Kg, Ch.-16194399
- 21) 03/94 - 04/02, carga útil 1000 Kg, 1400 Kg, Ch.16194400-
- 22) 03/94 - 04/02, carga útil 1800 Kg, Ch.16194400-
- 23) 04/02 - 07/04, carga útil 1000 Kg, 1400 Kg
- 24) 04/02 - 07/04, carga útil 1800 Kg
- 25) 07/96 - 04/02, carga útil 1000 Kg, 1400 Kg, Ch.-16194399

Observaciones

- | | | |
|--|---|---|
| <p>26) 07/96 - 04/02, carga útil 1800 Kg, Ch.-16194399</p> <p>27) 07/96 - 04/02, carga útil 1000 Kg, 1400 Kg, Ch.16194400-</p> <p>28) 07/96 - 04/02, carga útil 1800 Kg, Ch.16194400-</p> <p>29) 03/04 - 04/02, Ch.16194400-</p> <p>30) 04/02 - 07/04</p> <p>31) 10/01 - 04/02</p> <p>32) 11/00 - 09/01, carga útil 1000 Kg, 1400 Kg</p> <p>33) 11/00 - 09/01, carga útil 1800 Kg</p> <p>34) 07/96 - 04/02, frenos de tambor</p> <p>35) 07/96 - 04/02, frenos de disco</p> <p>36) 01/86 - 01/01, rueda izquierda, carga útil 1000 Kg, 1300 Kg, Ch.244301-</p> <p>37) 01/86 - 01/01, rueda derecha, carga útil 1000 Kg, 1300 Kg, Ch.244301-</p> | <p>63) frenos de tambor</p> <p>64) frenos de disco</p> <p>65) -02/85</p> <p>66) 03/85-</p> <p>67) -17/11/93</p> <p>68) 18/11/93-</p> <p>69) 10/87-</p> <p>70) ABS</p> <p>71) -12/92</p> <p>72) 01/93-</p> <p>73) 01/77-14/03/84</p> <p>74) 03/86-</p> <p>75) Excepto ABS. -08/91 excepto "Trilex"</p> <p>76) ABS. -08/91. excepto "Trilex"</p> <p>77) "Trilex" 20".-03/93.</p> <p>78) "Trilex" 24".-03/93.</p> <p>79) 09/91-03/93. excepto "Trilex"</p> <p>80) -02/86</p> <p>81) -12/87</p> <p>82) Tuerca M75. -05/91</p> <p>83) Tuerca M70. -05/91</p> <p>84) Excepto-ABS</p> <p>85) ABS</p> <p>86) -05/95</p> <p>87) 06/95-</p> <p>88) -03/89</p> <p>89) 04/89-</p> <p>90) 1973-1989</p> <p>91) Escluido motor G9T</p> <p>92) Con motor G9T</p> <p>96) 03/89 - 04/89, vehículo industrial, autobús, rodamiento interior 35x72x24.5 mm</p> <p>97) 03/89 - 04/89, autocarri legeri, autobús, rodamiento interior 35x62x18.3 mm</p> <p>98) 05/89 - 10/97, camioneta</p> <p>100) 03/80 - 04/89, vehículo industrial, autobús</p> <p>101) 03/80 - 04/89, camioneta</p> <p>102) 18/08/98 -</p> <p>103) - 31/03/98</p> <p>104) 01/04/98 -</p> <p>105) - 27/08/98</p> <p>106) - 24/08/98</p> <p>107) - 17/08/98</p> <p>108) Rueda simple</p> <p>109) Ruedas gemelas</p> <p>110) 01/09/91 - 31/03/93</p> <p>111) - 11/04/2000</p> <p>112) 12/04/2000 -</p> <p>113) 03/80 - 04/89</p> <p>114) 03/80 - 12/83, vehículo industrial, autobús</p> <p>115) 03/80 - 02/89</p> <p>116) 01/84 - 12/85, vehículo industrial, autobús,</p> <p>117) 01/86 - 02/89, vehículo industrial, autobús</p> <p>118) 03/89 - 04/89</p> <p>119) 05/89 - 01/01, vehículo industrial, autobús</p> <p>120) 05/89 - 01/01</p> <p>121) 05/89 - 01/01, camioneta, Model type:PC</p> <p>122) 05/89 - 01/01, vehículo industrial, autobús, cuscinetto interno 35x72x24.5 mm</p> <p>123) 05/89 - 01/01, vehículo industrial, autobús, cuscinetto interno 35x62x18.3 mm</p> <p>124) 03/01 - 11/02, excepto ABS</p> <p>125) 03/01 - 11/02, con ABS</p> <p>126) 11/02 - 02/04,</p> <p>127) 03/01 - 02/04</p> <p>128) 08/80 - 07/98, vehículo industrial, autobús,</p> <p>129) 09/80 - 07/98, camioneta</p> <p>130) 07/98 - 03/00</p> <p>131) 03/00 - 02/02</p> | <p>132) 07/98 - 01/01</p> <p>133) 07/98 - 10/01, vehículo industrial, autobús</p> <p>134) 07/98 - 10/01, vehículo industrial, camioneta</p> <p>135) 09/00 - 02/04, vehículo industrial, frenos de tambor</p> <p>136) 09/00 - 02/04, vehículo industrial, frenos de tambor</p> <p>137) 09/00 - 02/04, autobús, frenos de tambor</p> <p>138) 09/00 - 02/04, autobús, frenos de discos</p> <p>139) 09/00 - 02/04, camioneta, frenos de tambor</p> <p>140) 09/00 - 02/04, camioneta, frenos de disco</p> <p>141) 07/98 - 01/01, vehículo industrial, frenos de tambor</p> <p>142) 07/98 - 01/01, vehículo industrial, frenos de disco</p> <p>143) 10/01 - 02/04, vehículo industrial, frenos de tambor</p> <p>144) 10/01 - 02/04, vehículo industrial, frenos de disco</p> <p>145) 07/98 - 01/01, autobús, frenos de tambor</p> <p>146) 07/98 - 01/01, autobús, frenos de disco</p> <p>147) 10/01 - 02/04, autobús, frenos de tambor</p> <p>148) 10/01 - 02/04, autobús, frenos de disco</p> <p>149) 07/98 - 01/01, camioneta, frenos de tambor</p> <p>150) 07/98 - 01/01, camioneta, frenos de disco</p> <p>151) 10/01 - 02/04, camioneta, frenos de tambor</p> <p>152) 10/01 - 02/04, camioneta, frenos de disco</p> <p>153) 07/98 - 10/01, vehículo industrial, frenos de tambor</p> <p>154) 07/98 - 10/01, vehículo industrial, frenos de disco</p> <p>155) 07/98 - 10/01, camioneta, frenos de tambor</p> <p>156) 07/98 - 10/01, camioneta, frenos de disco</p> <p>157) 10/03 - 02/04, vehículo industrial, frenos de tambor</p> <p>158) 10/03 - 02/04, vehículo industrial, frenos de disco</p> <p>159) 10/03 - 02/04, autobús, frenos de tambor</p> <p>160) 10/03 - 02/04, autobús, frenos de disco</p> <p>161) 10/03 - 02/04, camioneta, frenos de tambor</p> <p>162) 10/03 - 02/04, camioneta, frenos de disco</p> |
|--|---|---|

RVI

- 12) -14/06/85
- 13) 17/06/85-
- 14) -12/82
- 15) 01/83-
- 16) -15/11/85
- 17) 18/11/85-
- 18) -1986
- 19) 1987-
- 22) 07/86-
- 23) -14/03/84
- 24) 15/03/84-
- 25) 10/84-01/86
- 26) 02/86-
- 27) -09/84
- 28) -01/86
- 29) 10/84-
- 30) -09/83
- 31) 10/83-
- 33) -08/79
- 34) 09/79-
- 35) -08/84 MOT 62030
- 36) -12/83
- 37) 01/84-
- 38) -12/85
- 39) 01/86-
- 40) 12/92-
- 41) -05/91
- 42) 06/91-03/93
- 43) 04/93-
- 44) -08/84 MOT 62030. -N 1539
- 45) -08/84 MOT 62030. N 1540-
- 47) 09/93-
- 48) excepto ABS. -08/91
- 49) ABS. -08/91
- 50) 09/91-03/93
- 51) 09/91-
- 52) -03/93
- 53) -08/91
- 54) -07/90
- 55) 08/90-
- 56) -02/91
- 57) 03/91-
- 58) -09/90
- 59) -02/92
- 60) 03/92-
- 61) -05/95
- 62) 06/95-

SCANIA

- 1) Ch.-1032241
- 2) Ch.1032242-
- 3) Ruedas de disco, ch.-1032241
- 4) Ruedas de disco, ch.1032242-
- 5) Ruedas de disco perforado
- 6) Ruedas de disco, ch.-1097602 SSS, ch.-4246024 SN
- 7) Ruedas de disco, ch.1097603 SSS-, ch.4246025 SN-
- 8) Ruedas de disco perf., ch.-1105665 SSS, ch.-4238514 SN
- 9) Ruedas de disco perf., ch.1105666 SSS-, ch.4238515 SN-
- 10) Ruedas de disco
- 11) Ruedas de disco perforado, ancho de chassiss 2300 mm
- 12) Ruedas de disco perf. cubo de 20" o 22.5", ch.-1103187 SSS, ch.-4248317 SN
- 13) Ruedas de disco perf. cubo de 20" o 22.5", ch.1103188 SSS-, ch.4248318 SN-
- 14) Ruedas de disco perforado cubo de 24"
- 15) Ch.-1097602 SSS, ch.-4246024 SN
- 16) Ch.1097603 SSS-, ch.4246025 SN-

Observaciones

- 17) Ruedas de disco, ch.-1033747
- 18) Ruedas de disco, ch.1033748-
- 19) Ruedas de disco perf. cubo de 20" o 22", ch.-1103187 SSS, ch.-4248317 SN
- 20) Ruedas de disco perf. cubo de 20" o 22", ch.1103188 SSS-, ch.4248318 SN-
- 21) Ruedas de disco, ruedas de disco perforado
- 22) Ruedas de disco (4x2, 6x2, 6x4)
- 23) Ruedas de disco perf. (4x2, 6x2, 6x4) cubo de 20" o 22.5"
- 24) Ruedas de disco perf. cubo de 24". Zapata 178 mm
- 25) Ruedas de disco perf. cubo de 24". Zapata 203 mm
- 26) Eje de dirección gemelo
- 27) Ruedas de disco perf. cubo de 20", 22.5", 24"
- 28) Sin cubo reductor
- 29) Con cubo reductor
- 30) Ruedas de disco, ch.-1029858
- 31) Ruedas de disco, ch.1029859-
- 32) Ruedas de disco, ruedas de disco perf. cubo de 24"
- 33) Ruedas de disco, ruedas de disco perf. cubo de 20" o 22.5"
- 34) Ruedas de disco, ruedas de disco perf. cubo de 20", 22.5" o
- 35) Ruedas de disco, ch.-1161721 SSS, ch.-4292924 SN
- 36) Ruedas de disco, ch.1161722 SSS-, ch.4292925 SN-
- 37) Ruedas de disco, ruedas de disco perf. cubo de 24", ch.-1180029 SSS
- 38) Ruedas de disco, ruedas de disco perf. cubo de 24", ch.1180030 SSS-
- 39) Ruedas de disco, ch.-1850412
- 40) Ruedas de disco, ch.1850413-
- 41) Suspensión de ballestas. ch.-1801229
- 42) Suspensión de ballestas. ch.1801230-
- 43) Suspensión neumática, ch.-1802872
- 44) Suspensión neumática, ch.1802873-
- 45) Ch.-1801229
- 46) Ch.1801230-
- 47) Ruedas de disco. ABS/Excepto ABS
- 48) ABS/Excepto ABS
- 49) Suspensión neumática
- 50) Suspensión neumática/ABS
- 51) Suspensión neumática. Suspensión trapecio
- 52) Suspensión neumática. Suspensión trapecio. ABS
- 53) Ruedas de disco, ch.-1871409
- 54) Ch.1871410-1871595
- 55) Ch.1871596-
- 56) Ch.1871410-
- 57) Zapata 5"
- 58) Zapata 7". Ch.1801196-
- 59) Ch.-1801195
- 60) Ch.1801196-
- 61) Ch.-1808231
- 62) Ch.1808232-
- 63) ABS/Excepto ABS. Ch.-1808901, Ch.1808902-
- 64) ABS/Excepto ABS. Ch.-1806768, Ch.1806769-
- 65) Cubo de eje remolque
- 66) Ruedas de disco, ABS/Excepto ABS. Ch.-1808901, ch. 1808902
- 67) Suspensión neumática. Cubo de 22.5"
- 68) Suspensión neumática. Cubo de 22.5". ABS
- 69) ABS

- 70) Cubo de 8.25 x 22.5"
- 71) Cubo de 8.25 x 22.5". ABS
- 72) Cubo de 9.00 x 22.5"
- 73) Cubo de 9.00 x 22.5". ABS
- 74) 6.5 tons
- 75) 6.5 tons. ABS
- 76) 7.1 tons
- 77) 7.1 tons. ABS
- 78) 6.5 tons. Ch.-1820117
- 79) 6.5 tons. Ch.-1820117. ABS
- 80) 7.1 tons. Ch.-1820117
- 81) 7.1 tons. Ch.-1820117. ABS
- 82) ABS/Excepto ABS. Ch.-1820117, ch.1820118-
- 83) Suspensión neumática, ch.-1801229
- 84) Suspensión neumática, ch.1801230-1802872
- 85) Ruedas de disco, Excepto ABS, Ch.9015825 SAN-, ch.4362206 SNL-, ch.1226892 SSS-
- 86) Ruedas de disco, ABS, Ch.9015825-SAN, Ch.4362207 SNL-, ch.1226892 SSS-
- 87) Ruedas de disco perf., ABS/Excepto ABS
- 88) Ruedas de disco, ABS/Excepto ABS, Ch.9015825 SAN, ch.4362207 SNL-, ch.1226892 SSS-
- 89) Ruedas de disco, Excepto ABS, Ch.9015825 SAN, ch.4362207 SNL-, ch.1226207 SSS-
- 90) Ruedas de disco, Excepto ABS
- 91) Ruedas de disco, Excepto ABS, RP/RBP730
- 92) No ABS, RP/RBP832
- 93) Ruedas de disco, ABS
- 94) Ruedas de disco/Ruedas de disco perf., ABS/Excepto ABS, 9015825 SAN-, ch.4362207 SNL-, ch.1226892 SSS-
- 95) Ruedas de disco, Excepto ABS
- 96) Ruedas de disco, Ch.1820118-, ABS
- 97) Ruedas de disco, Ch.1820118-, Excepto ABS
- 98) -ch. Scania Sodertälje 1242205, Scania Zwlolle 4397541, Scania Angers 9034654, Scania Katrineholm 1833391
- 99) Ruedas de disco, Frenos de disco, ABS
- 100) Ruedas de disco, perforado cubo de 22" y 22.5
- 101) RP/RBP 832
- 102) Cubo de 22", 22.5" y 24"
- 103) Cubo de 20" y 22.5, RBP/RP 730
- 104) Cubo de 24", RP/RBP 832
- 105) Ruedas de disco, ch.-9015824 SAN, ch.-4365570 SNL, ch.-1226891 SSS
- 106) Ruedas de disco, ABS, ch.-9015824 SAN, ch.-4362206 SNL, ch.-1226891 SSS
- 107) Ruedas de disco, frenos de disco, ABS/Excepto ABS

SMB

- 1) Eje 107, 6 mm, frenos C/C2
- 2) Eje 110 mm, frenos D1/K1/H1
- 3) Eje 110 mm, frenos C1/C2/L1/L2 (100 dientes)
- 4) Eje 110 mm, frenos C3/C5 (80 dientes)

TRAILOR

- 1) Eje 107, 6 mm, frenos C/C2
- 2) Eje 110 mm, frenos D1/K1/H1

- 3) Eje 110 mm, frenos C1/C2/L1/L2 (100 dientes)
- 4) Eje 110 mm, frenos C3/C5 (80 dientes)

VOLKSWAGEN

- 1) 1976-96
- 5) Ch.21N-006786 -, 08/91-96, Anillo de retención de 22.5 mm
- 7) Excepto rueda gemela. Ch.28G-015892 - 21N-006785, 04/86-07/91, Anillo de retención de 20 mm
- 8) Excepto rueda gemela. Ch.21N-006786 -, 08/91-96, Anillo de retención de 22.5 mm
- 9) Resorte de espiral, 1979-82
- 10) Ballesta, ch.-28-B-018540, 1979-81
- 11) Ballesta, ch.28-B-018541-, 1981-82
- 12) 1979-82
- 13) Ch.-28-B-019162, 1979-81
- 14) Ch.28-B-019163-, 1981-82
- 15) 1983-96
- 16) 3500 kg, 1983-96
- 17) 4000 kg, 1983-96
- 18) 1984-96
- 19) 05/96 - 10/04
- 20) 05/96 - 10/04, Mod. LT 28, LT 35
- 21) 05/96 - 10/04, Mod. LT 46
- 22) 08/67 - 07/79
- 23) 08/71 - 12/73
- 24) 08/75 - 07/79
- 25) 08/70 - 07/92
- 26) 08/79 - 12/82
- 27) 08/79 - 12/84, Ch.-24-E-023827
- 28) 01/84 - 07/92, Ch.24-E-023828 -
- 29) 10/86 - 07/92
- 30) 01/84 - 07/92, Ch.24-E-023828 -
- 31) 08/85 - 07/92
- 32) 11/84 - 07/92
- 33) 08/75 - 07/92
- 34) 07/90 - 10/04
- 35) 10/92 - 10/04
- 36) 07/90 - 10/04, 800-1200 Kg
- 37) 10/92 - 10/04, 800-1200 Kg
- 38) 04/03 - 09/04, Ch.-7 H-4-017500, 7J-4-017500
- 39) 07/04 - 09/04, Ch.-7 H-4-017500, 7J-4-017500
- 40) 04/03 - 10/04
- 41) 07/04 - 10/04

VOLVO

- 1) Cubo 363067
- 2) Mangueta de 57 mm
- 3) Ch.-20653
- 4) Ruedas de disco, ch.20654-
- 5) Ruedas de disco perforado, ch.20654
- 6) Ruedas de disco, ruedas de disco perf., -1503875
- 7) Ruedas de disco, perforado, 1503876-
- 8) Sin cubo reductor, ch.36634-
- 9) Con cubo reductor
- 10) Sin cubo reductor
- 11) Ruedas de disco
- 12) Ruedas de disco perforado
- 13) Ch.-6997

Observaciones

- 14) Ruedas de disco, ch.6998-
15) Ruedas de disco perforado, ch.6998-
16) Ballestas duras
17) Ballestas blandas
18) Ch.-7050
19) Ch.7051-
20) Ch.-23510
21) Ch.23511-
22) Ch.-2376
23) Ch.2377-
24) Ch.-6450
25) Ch.6451-
26) Ch.-703
27) Ch.704-
28) Ch.-21671
29) Ch.21672-
30) Hasta ch.-3145 (aprox.)
31) Ch.3146 (aprox.) -6871
32) Ch.6872-
33) Ch.-2728
34) Ch.2729-6871
35) ABS/Excepto ABS
36) Eje rigido, semirigido
37) Para vehiculos con construccion fija
38) Para vehiculos con construccion no fija
39) Ruedas de disco, perno diam.335 mm
40) ABS/No ABS. Ruedas de disco, perno diam.335 mm
41) Ruedas de disco, ch.-27087
42) Ruedas de disco, ch.27088-
43) Ruedas de disco perforado cubo de 20", ch.-27087
44) Ruedas de disco perforado cubo de 22", ch.-27087
45) Ruedas de disco perforado, ch.27088-
46) Ruedas de disco perforado cubo de 20"
47) Ruedas de disco perforado, sin cubo reductor
48) Ruedas de disco, ch.-19745
49) Ruedas de disco, ch.19746-
50) Suspension neumatica y diseno especial
51) Con montaje S y rueda unica
52) Ruedas de disco, primeros modelos
53) Ruedas de disco perforado, primeros modelos
54) Construccion con eje delantero recto
55) Ruedas de disco perforado, ABS/Excepto ABS
56) Ruedas de disco, ABS/Excepto ABS
57) Ruedas de disco BGT 18/21/26 con suspension trasera de ballestas
58) Ruedas de disco, susp.neumatica, montaje S, direccion trasera
59) Suspension neumatica y direccion trasera
60) ABS/Excepto ABS, con suspension de ballestas.
61) Ch.-12099
62) Ch.12100-
63) Ch.12001-
64) Ruedas de disco, ch.-11549
65) Ruedas de disco, ch.11550-
66) Ch.-26821
67) Ch.26822-
68) Ruedas de disco, ch.-40640, ABS/Excepto ABS
69) Ruedas de disco perforado cubo de 20", sin cubo reductor
70) Ruedas de disco perforado cubo de 24", sin cubo reductor
71) Ruedas de disco, ch.-20876, ABS/Excepto ABS
72) Ruedas de disco, ch.20877-, ABS/Excepto ABS
73) Ruedas de disco, ch-25001-40640, perno diam.335 mm
74) Ruedas de disco perforado cubo de 20", ch.25001-40640
75) Ruedas de disco perforado cubo de 24", ch.25001-40640
76) Suspension neumatica, ch.-25000
77) Montaje S, direccion trasera, ch.25001-40640
78) Ruedas de disco, con cubo reductor
79) Ch.-52439
80) Ch.52440-
81) Ruedas de disco, ch.306000-, perno diam.335 mm
82) Ruedas de disco perforado cubo de 20" y 24", ch.306000-
83) Ruedas de disco, ch.306000-, ABS/No ABS, perno diam. 335
84) Ruedas de disco, ch.-46315
85) Ruedas de disco, ch.46316-, ABS/Excepto ABS
86) Ruedas de disco perforado cubo de 24", ch.49001-
87) Ruedas de disco cubo de 20", 22.5" y 24"
88) Construccion con eje delantero recto
89) Ruedas de disco perforado cubo de 24"
90) Ch.-36763
91) Ch.36764-
92) Ch.-65820
93) Ch.-65820, Ruedas de disco perforado cubo de 20" y 24"
94) Ruedas de disco, sin cubo reductor
95) Ruedas de disco, ch.-22914
96) Ruedas de disco, ch.22915-
97) Ruedas de disco perforado cubo de 20", ch.34001-
98) Ruedas de disco perforado cubo de 24", ch.34001-
99) Suspension neumatica
100) Modelo especial, super volumen S-10609, S-10610, S-10801, S-11010, S-97024, S-97025, ch.314000-
101) Ruedas de disco perforado cubo de 20" y 24"
102) Ruedas de disco perforado, con reduccion unica
103) Eje tandem con cubo reductor
104) Rueda trasera unica, ruedas de disco
105) Rueda trasera doble, ruedas de disco
106) Ch.-15169
107) Ch.15170-
108) Ruedas de disco, ch.-8779
109) Ruedas de disco, ch.8780-
110) Ruedas de disco perforado, ch.-12000
111) Ruedas de disco perforado cubo de 20", ch.12001-
112) Ruedas de disco perforado cubo de 24", ch.12001-
113) Ruedas de disco perforado cubo de 22", 22.5" y 24"
114) Ruedas de disco perf. cubo de 20", con susp. de ballestas,ABS/Exepto ABS
115) Ruedas de disco perf. cubo de 24", con susp. de ballestas.
116) Ruedas de disco perf. cubo de 20", suspension neumatica
117) Ruedas de disco, ch.314000-, suspension neumatica, trasera
118) Modelo especial, super volumen; 1) S-10099, S-10365, S-10803, S-11011 2), S-10111, S-97024, S-10365
119) Ch.7980
120) Ch.7981-
121) Ch.-3404
122) Ch.3405-7980
123) Ch.-5256
124) Ch.5257-
125) B 6F
126) B 6FA
127) Ch.865-.No ch.873-875, lubricado con aceite
128) B 6F, B 609, B 610
129) B 6FA, ch.-404. Cubo 6772232
130) B 6FA, ch.405-
131) Ch.20000-
132) Ch.-10521. lubricado con grasa
133) Ch.10522-. lubricado con aceite
134) Lubricado con grasa y direccion trasera
135) Lubricado con grasa y direccion trasera. ABS/No-ABS
136) Lubricado con aceite
137) Ch.-3906
138) Ch.3907-
139) Ch.4308-. ABS
140) Con FAT 5,0
141) CHID -B169140. Ruedas de disco, perno diam. 335 mm
142) Excepto ABS. Ruedas de disco, perno diam. 335 mm
143) Cubo 6774825. Con FAT 4,7
144) CHID -B170985
145) CHID B170986-
146) S-60677, S-60936
147) Ruedas de disco, perno diam. 335 mm, con suspension neumatica
148) Ruedas de disco, perno diam. 335 mm, BAT 11,5 con suspension de ballestas
149) 6X2 TAG (HENDRICKSON)
150) Cubo 6774825,6795568
151) Modelo especial; S-60945, S-60990, S-60993, S-61208, S-61230
152) B 6FA, ch.-404. Cubo 6010088
153) ABS/Excepto ABS. Ch.5000-
154) Ch.5000-
155) CHID.-A 276505, -B 190367, -563621
156) BAT 10.0, BAT 10.9, BAT 11.2
157) BAT 11.5 BLF-B, BAT 13.0
158) BAT 11.5, LUF-B
159) FAT 4.7
160) WTT-D 275
161) Ch.-A286102, -B207062, D120498



Hoe deze catalogus te gebruiken

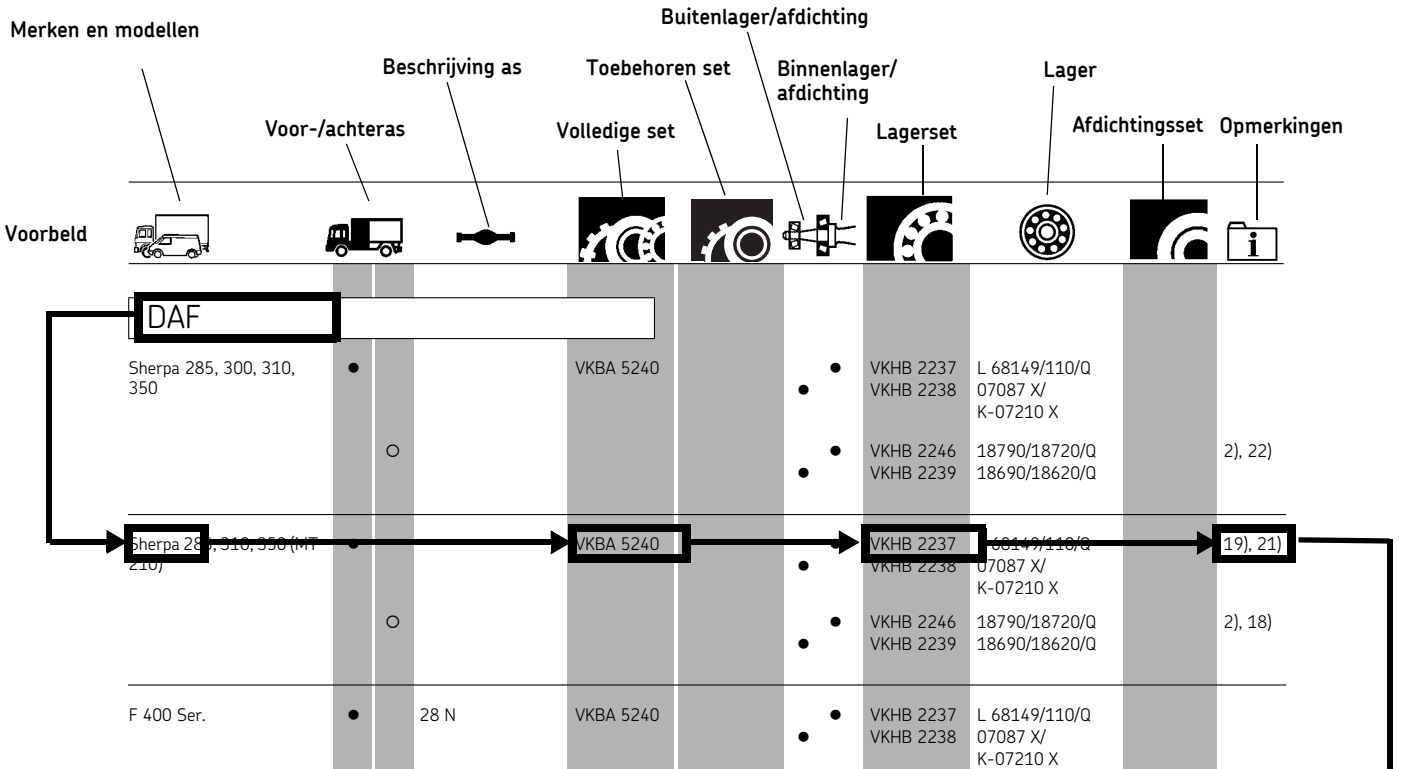







Inhoud van de set

	A	B	C	D	E	F	G	H	I	J	K	L			
VKA 4004							1		1				VOLVO	●	○
VKA 4026							1		1				VOLVO		○
VKA 4036							2	1					SCANIA		○
VKA 4038							1	1					SCANIA		○
VKA 4094							2	1					MERCEDES-BENZ	●	○
VKA 4095							1	2					MERCEDES-BENZ	●	○

A	B	C	D	E	F	G	H	I	J	K	L	
Lager	Borgaf-dichtring	Moer	Afstands-stuk	Borgring	Borgveer	Afdichting	Pakking	O-ring	Afdek-plaat	Splitpen	Diverse	



VKBA = VKHB + VKHB + VKA/VKS

						
VKBA 5025 VKBA 5026		VKHB 2056 VKHB 2059	VKHB 2057 VKHB 2007	VKS 6290		

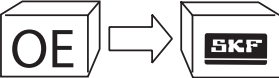
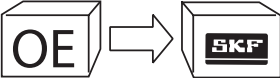
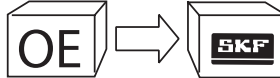

Crosslijst -OE naar SKF

		
BPW 02.5664.26.57 02.5664.46.57 02.5664.55.57	0174592 0174595 0190069 0221664 0266487	FIAT / IVECO 1101597 1102042
VKS 6285 VKS 6287 VKS 6250 VKS 6251	VKHB 2043 VKHB 2141 VKS 6171 VKHB 2222 VKHB 2223	VKHB 2060 VKHB 2282 VKHB 2283





Crosslijst - SKF naar OE

	
VKBA 519 VKBA 523 VKBA 528	VKBA 3616
VW VW FORD FORD MERCEDES BENZ	RENAULT / RVI OPEL OPEL OPEL
211 498 071 211 498 071 BS 5 007 029 5 007 028 116 320 00 51	77 01 206 742 44 08 669 91160087 77 01 206 848 1102042

Lager - SKF VKHB

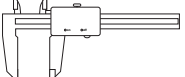
		
07087 X/K-07210 X 100 300 000	VKHB 2238 VKHB 2268 VKHB 2269	VKHB 2175 VKHB 2176
32310 TN9 32311 12	VKHB 2303 VKHB 2304	32500/39520/Q

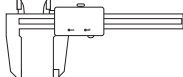
Zoeken op afmetingen (afdichtingen)

					
d	D	W	d	D	W
44,0 53,0	85,0 97,0	10,0/8,0 8,0 13,0	117,4 118,0	142,8	12,7 27,0
		VKS 6229 VKS 6219			VKS 6108 VKS 6109



Symbolen

Symbolen gebruikt in deze catalogus

	Nieuwe sets en vervanginen		VKBA=VKHB+VKHB+VKA/VKS
	Toepassingslijst – trucks		Crosslijst – OE naar SKF
	Toepassingslijst – bussen		Crosslijst – SKF naar OE
	Toepassingslijst – trailers		Lager – SKF VKHB
	Inhoud van de set		Zoeken op afmetingen (afdichtingen)

Universele symbolen

	Tot
	Vanaf
	Vervangen sets
	Geschrapte sets
	Gereedschap

Afkortingen

CH	Chassis nummer
Forward rear axle	Vooruit achteras
Rear rear axle	Achterkant achteras
Trailing axle	Niet-aangedreven achteras

VKBA XXXX	In productie
VKHB XXXX	In productie
VKA XXXX	In productie
VKS XXXX	In productie
VKN XXX	In productie

Opmerkingen

BPW

- 1) Dieplader
- 2) Behalve dieplader

CITROËN

- 1) 09/81 - 12/89, Ch.-604496
- 2) 01/89 - 03/04, Ch.604497 -
- 3) 02/91 - 03/94
- 4) 01/87 - 12/89, Ch.-604496
- 5) 01/89 - 02/94, Ch. 604497 -
- 6) 09/81 - 12/86, linker wiel, Ch.-289710, nuttige last : 1000, 1300 Kg
- 7) 09/81 - 12/86, rechter wiel, Ch.-289710, nuttige last : 1000, 1300 Kg
- 8) 09/81 - 03/94, linker wiel, nuttige last :1800 Kg
- 9) 09/81 - 03/94, rechter wiel, nuttige last : 1800 Kg
- 10) 01/86 - 03/94, linker wiel, Ch.289711-, nuttige last : 1000, 1300, 1400 Kg
- 11) 01/86 - 03/94, rechter wiel, Ch.289711-, nuttige last : 1000, 1300, 1400 Kg
- 12) 01/87 - 02/94,
- 13) 02/94 - 04/02, Ch.-16194399, nuttige last :1000, 1400 Kg
- 14) 02/94 - 04/02, Ch.-16194399, nuttige last : 1800 Kg
- 15) 02/94 - 04/02, Ch.16194400 -, nuttige last : 1000, 1400 Kg
- 16) 02/94 - 04/02, Ch.16194400 -, nuttige last : 1800 Kg
- 17) 04/02 - 09/04, nuttige last : 1000, 1400 Kg
- 18) 04/02 - 09/04, nuttige last : 1800 Kg
- 19) 03/94 - 04/02, Ch.-16194399, nuttige last : 1000, 1400 Kg
- 20) 03/94 - 04/02, Ch.-16194399, nuttige last : 1800 Kg
- 21) 03/94 - 04/02, Ch.16194400 -, nuttige last : 1000, 1400 Kg
- 22) 03/94 - 04/02, Ch.16194400 -, nuttige last : 1800 Kg
- 23) 08/96 - 04/02, Ch.-16194399, nuttige last : 1000, 1400 Kg
- 24) 08/96 - 04/02, Ch.-16194399, nuttige last : 1800 Kg
- 25) 08/96 - 04/02, Ch.16194400 -, nuttige last : 1000, 1400 Kg
- 26) 08/96 - 04/02, Ch.16194400 -, nuttige last : 1800 Kg
- 27) 02/94 - 04/02, Ch.16194400 -
- 28) Trommelremmen
- 29) Schijfremmen

DAF

- 2) Dubbel achterwiel
- 3) Spoorbreedte 1718 mm, met hub met 10 bouten
- 4) Spoorbreedte 1655 mm, met hub met 8 bouten
- 5) Behalve hub centrering
- 6) Met hub centrering

- 7) Met hub centrering. Zwarte afdichting
- 8) Met hub centrering. Blauwe afdichting
- 9) Met hub reductie
- 10) Behalve FAR
- 11) Met FAR
- 12) Behalve FA, FT
- 13) Met FA, FT
- 14) Behalve hub centrering. Zwarte afdichting
- 15) Behalve hub centrering. Blauwe afdichting
- 16) Zwarte afdichting
- 17) Blauwe afdichting
- 18) 1983-85
- 19) Ch.237886-, enkel achterwiel
- 21) 1984-85
- 22) 1985-12/89
- 23) -12/89
- 24) Oliekeerring/ABS-ring niet geïntegreerd

FIAT-IVECO

- 4) Linker wiel
- 5) Rechter wiel
- 8) Linker wiel, 06/79-06/81
- 9) Rechter wiel, 06/79-06/81
- 10) 10/77-06/81
- 11) Linker wiel, 06/81-09/84
- 12) Rechter wiel, 06/81-09/84
- 13) 06/81-09/84
- 14) Linker wiel, 10/84-88
- 15) Rechter wiel, 10/84-88
- 16) 10/84-88
- 17) 03/85-88
- 18) Ch.-604496, 1982-89
- 19) Ch.604497-, 1989-93
- 20) Linker wiel, ch.-278757, 1982-86
- 21) Rechter wiel, ch.-278757, 1982-86
- 22) Linker wiel, ch.278758-, 1986-93
- 23) Rechter wiel, ch.278758-, 1986-93
- 24) 1982-86
- 25) Ch.-604496, 1986-89
- 26) Linker wiel, 1986-93
- 27) Rechter wiel, 1986-93
- 28) 10/77-12/86
- 29) 01/87-
- 30) Behalve 50-9 D, 50-9 V
- 31) 04/91-04/92
- 32) 01/85-
- 33) Schijfremmen
- 34) 12/85-
- 36) 1991-94
- 37) Linker wiel, 1991-94
- 38) Rechter wiel, 1991-94
- 39) Behalve ABS
- 40) Behalve modellen voor Zwitserland
- 41) Modellen voor Zwitserland
- 42) Ratio 4.23/1
- 43) Behalve ratio 4.23/1
- 44) Ratio 4.23/1. Behalve modellen voor Zwitserland
- 45) Behalve ratio 4.23/1. Behalve modellen voor Zwitserland
- 46) Behalve ratio 3.79/1
- 47) Ratio 3.79/1
- 48) CH. -173788
- 49) Ch.173789-. as -1824487

- 50) Ch.173789-. as 1824488-
- 51) Ch.173789-
- 52) 95 mm boordiameter binnenlager
- 53) 105 mm boordiameter binnenlager. As -1824487
- 54) 105 mm boordiameter binnenlager. As 1824488-
- 55) Gestuurde as. Niet-gestuurde as, onderdeel nr 7177196
- 56) Niet-gestuurde as, onderdeel nr 7177168
- 57) 100 mm boordiameter binnenlager
- 58) As -1824487
- 59) As 1824488-
- 60) Linker wiel, 06/79-01/97
- 61) Rechter wiel, 06/79-01/97
- 62) 06/81-01/97
- 63) Linker wiel, 06/81-88
- 64) Rechter wiel, 06/81-88
- 65) Behalve ratio 5.22/1. -02/96
- 66) Ratio 5.22/1. -02/96
- 67) Linker wiel, 06/79-02/96
- 68) Rechter wiel, 06/79-02/96
- 69) 10/77-09/84
- 70) Behalve "Iveco check control"
- 71) "Iveco check control"
- 72) Linker wiel, -02/96
- 73) Rechter wiel, -02/96
- 74) -2/96
- 75) Ratio 5.62/1
- 76) Behalve ratio 5.62/1
- 77) ABS
- 78) Linker wiel, 03/85-88
- 79) Rechter wiel, 03/85-88
- 81) 02/96
- 82) 03/96-
- 83) 1994-
- 84) 1996-
- 85) Eénrijig kegellager
- 86) Dubbelrijig kegellager
- 87) Niet-gestuurde as
- 88) Gestuurde as
- 89) Voorwielaandrijving
- 90) Behalve voorwielaandrijving
- 91) Linker voorwiel, éénrijig kegellager, 03/96 - 12/99
- 92) Rechter voorwiel, éénrijig kegellager, 03/96 - 12/99
- 93) Dubbelrijig kegellager
- 94) Tot 05/89
- 95) 06/89 - 01/97
- 96) 01/96 - 12/99
- 97) Tot 12/99
- 98) 05/99 - 08/03
- 99) 06/81 - 01/97
- 100) 04/02 - 01/04
- 101) 07/02 - 01/04
- 102) Nuttige last 1100, 1500 Kg
- 103) Nuttige last 1800 Kg

FORD

- 1) 1965-91
- 2) 07/74-12/77
- 3) 08/65-12/77
- 6) 11/73-12/77

Opmerkingen

- 7) 01/78-10/85
- 8) Linker wiel, 11/85-91
- 9) Rechter wiel, 11/85-91
- 10) 11/85-91
- 11) 1992-97
- 12) 01/81-03/87
- 13) 03/87-12/92
- 14) 04/82 - 09/87
- 15) 10/87 - 12/90. Linker wiel
- 16) 10/87 - 12/90. Rechter wiel
- 18) 01/00 - 10/04
- 19) 01/00 - 10/04, behalve ABS, nuttige last 1000 Kg, FWD
- 20) 01/00 - 10/04, ABS, nuttige last 1000 Kg, FWD
- 21) 07/03 - 10/04, behalve ABS, nuttige last 2000 Kg, FWD
- 22) 07/03 - 10/04, ABS, nuttige last 2000 Kg, FWD
- 23) 01/00 - 10/04, enkel wiel, RWD
- 24) 01/00 - 10/04, tandem wiel, RWD
- 25) 03/04 - 10/04, behalve ABS, nuttige last 2000 Kg
- 26) 03/04 - 10/04, ABS, nuttige last 2000 Kg

GIGANT (SAE)

- 1) Luchtvering Type N
- 2) Protec as

FRUEHAUF

- 1) 107, 6 mm as, met remmen C1/C2-
- 2) 110 mm as, met remmen D1/K1/H1
- 3) 110 mm as, met remmen C1/C2/L1/L2 (100 tanden)
- 4) 110 mm as, met remmen C3/C5 (80 tanden)

MAN

- 1) -11/93
- 2) 12/93-
- 3) W25/86-W27/90
- 4) W28/90-
- 5) Behalve ABS
- 6) ABS
- 7) 01/90-
- 8) Hub. 81.35701.0081
- 9) Hub. 81.35701.0127
- 10) 20"TRILEX
- 11) Hub. 81.35701.0141
- 12) Behalve "TRILEX"
- 13) "TRILEX"
- 14) -W18/94
- 15) W19/94-
- 16) -W27/96
- 17) W28/96-, 19.5"hub
- 18) W28/96-, 20/22.5"hub

MERCEDES-BENZ

- 1) 02/88 - 02/96
- 2) 02/88 - 02/96, Ch.-128165
- 3) 1983-94
- 4) Ch.-48630
- 5) Ch.48631-
- 6) Diesel motor ch.-17768, benzinemotor ch.-1288
- 7) Diesel motor ch.17768-78114, benzinemotor ch.1289-4706
- 8) Diesel motor ch.78115-, benzinemotor ch.4707-
- 9) 55 mm boordiameter binnenlager
- 10) As -1358880
- 11) As 1358881-
- 12) 02/88 - 02/96, Ch.128166-
- 13) As -1278813
- 14) As 1278814-
- 15) 02/88 - 05/92. Dieplader
- 16) 02/73 - 12/77
- 17) 01/95 - 05/02, vanaf as: S213915/Y245976
- 18) 01/95 - 05/02
- 19) As -1390839
- 20) As 1390840-
- 21) As -1278313
- 22) As 1278314-
- 23) 02/95 - 07/04, vanaf as: S231915/Y245976
- 24) Trommelrem
- 25) Met ABS, as -021298
- 26) Met ABS, as 021299-
- 27) As -724723
- 28) As 724724-
- 29) Hub: 355 356 44 01
- 30) Hub: 346 356 30 01
- 31) 02/95 - 07/04
- 32) 02/96 - 05/02, vanaf as: S231915/Y245976
- 33) 02/96 - 05/02,
- 34) 09/96 - 07/04
- 35) 02/96 - 07/04
- 37) Hub: 668 356 01 01, 668 356 02 01
- 38) Hub: 972 356 01 01
- 39) Hub: 976 356 11 01
- 40) Hub: 678 356 04 01
- 41) Hub: 675 356 01 01
- 42) Schijfrem
- 43) Hub: 942 334 08 01
- 44) Hub: 942 334 07 01, 949 334 05 01

MERITOR (ROR)

- 1) Vetgesmeerd

MONTENEGRO

- 1) As 061001243, 061001243A
- 2) As 06-1-1068
- 3) As 06-1-1176, 061001231
- 4) As 061001271
- 5) As 061001231A

- 6) As 061001230, 061001230A
- 7) As 06-1-1025
- 8) As 061001170A
- 9) As 061001299
- 10) As 061001210, 061001210B, 061001295
- 11) As 06-1-1103, 06-1-1170
- 12) As 06-1-1100, 06-1-1102, 06-1-1106, 06-1-1108, 06-1-1173, 06-1-1174

OPEL

- 1) 09/00 - 10/01, wiel 15", Ch.-B 000010, motor referentie: F9Q-770
- 2) 09/00 - 10/01, wiel 15", Ch. B 000011-, motor referentie: F9Q-770
- 3) 07/98 - 10/01, wiel 16"
- 4) 07/98 - 10/01, dieplater, wiel 15", Ch.-B 0000514, B 006055, motor referentie: S8U-702
- 5) 07/98 - 10/01, box, bus, dumptruck, wiel 15", Ch.-B 051615, motor referentie: S9W-702
- 6) 07/98 - 10/01, dieplater, wiel 15", Ch.B 0000515-, B 006056-, motor referentie: S8U-702
- 7) 07/98 - 10/01, box, bus, dumptruck, wiel 15", Ch.B 051616-, motor referentie: S9W-702
- 8) 07/98 - 10/01, wiel 15"
- 9) 07/98 - 10/01, wiel 16"
- 10) 08/01 - 08/05, behalve ABS, Ch.-3V613233
- 11) 08/01 - 08/05, met ABS, Ch.-3V613233
- 13) 08/01 - 08/05

PEUGEOT

- 1) 01/83 - 11/88
- 2) 10/90 - 01/01
- 3) 09/81 - 12/89, Ch.-604496
- 4) 01/89 - 09/90, Ch.604497-
- 5) 09/81 - 12/85, linker wiel, nuttige last 1000 Kg, 1300 Kg, Ch.-244300
- 6) 09/81 - 01/01, linker wiel, nuttige last 1400 Kg
- 7) 09/81 - 01/01, linker wiel, nuttige last 1800 Kg
- 8) 09/81 - 01/01, rechter wiel, nuttige last 1400 Kg
- 9) 09/81 - 01/01, rechter wiel, nuttige last 1800 Kg
- 10) 01/86 - 11/88, linker wiel, nuttige last 1000 Kg, 1300 Kg, Ch. 244301-
- 11) 09/81 - 12/85, rechter wiel, nuttige last 1000 Kg, 1300 Kg, Ch.-244300
- 12) 01/86 - 11/88, rechter wiel, nuttige last 1000 Kg, 1300 Kg, Ch.244301-
- 13) 10/90 - 01/01, linker wiel, nuttige last 1000 Kg, 1300 Kg
- 14) 10/90 - 01/01, rechter wiel, nuttige last 1000 Kg, 1300 Kg
- 15) 1967-09/70
- 16) 10/70-80
- 17) 1967-80

Opmerkingen

- | | | |
|--|--|---|
| 18) 1980-88 | 45) -08/84 MOT 62030. N 1540 | 114) 03/80 - 12/83, box, bus |
| 19) 03/94 - 04/02, nuttige last 1000 Kg, 1400 Kg, Ch.-16194399 | 47) 09/93- | 115) 03/80 - 02/89 |
| 20) 03/94 - 04/02, nuttige last 1800 Kg, Ch.-16194399 | 48) Behalve ABS. -08/91 | 116) 01/84 - 12/85, box, bus |
| 21) 03/94 - 04/02, nuttige last 1000 Kg, 1400 Kg, Ch.16194400- | 49) ABS. -08/91 | 117) 01/86 - 02/89, box, bus |
| 22) 03/94 - 04/02, nuttige last 1800 Kg, Ch.16194400- | 50) 09/91-03/93 | 118) 03/89 - 04/89 |
| 23) 04/02 - 07/04, nuttige last 1000 Kg, 1400 Kg | 51) 09/91- | 119) 05/89 - 01/01, box, bus |
| 24) 04/02 - 07/04, nuttige last 1800 Kg | 52) -03/93 | 120) 05/89 - 01/01 |
| 25) 07/96 - 04/02, nuttige last 1000 Kg, 1400 Kg, Ch.-16194399 | 53) -08/91 | 121) 05/89 - 01/01, dieplader, model type:PC |
| 26) 07/96 - 04/02, nuttige last 1800 Kg, Ch.-16194399 | 54) -07/90 | 122) 05/89 - 01/01, box, bus, binnenlager 35x72x24.5 mm |
| 27) 07/96 - 04/02, nuttige last 1000 Kg, 1400 Kg, Ch.16194400- | 55) 08/90- | 123) 05/89 - 01/01, box, bus, binnenlager 35x62x18.3 mm |
| 28) 07/96 - 04/02, nuttige last 1800 Kg, Ch.16194400- | 56) -02/91 | 124) 03/01 - 11/02, behalve ABS |
| 29) 03/04 - 04/02, Ch.16194400- | 57) 03/91- | 125) 03/01 - 11/02, met ABS |
| 30) 04/02 - 07/04 | 58) -09/90 | 126) 11/02 - 02/04 |
| 31) 10/01 - 04/02 | 59) -02/92 | 127) 03/01 - 02/04 |
| 32) 11/00 - 09/01, nuttige last 1000 Kg, 1400 Kg | 60) 03/92- | 128) 08/80 - 07/98, box, bus |
| 33) 11/00 - 09/01, nuttige last 1800 Kg | 61) -05/95 | 129) 09/80 - 07/98, dieplader |
| 34) 07/96 - 04/02, trommelrem | 62) 06/95- | 130) 07/98 - 03/00 |
| 35) 07/96 - 04/02, schijfrem | 63) Trommelremmen | 131) 03/00 - 02/02 |
| 36) 01/86 - 01/01, linker wiel, nuttige last 1000 Kg, 1300 Kg, Ch.244301- | 64) Schijfremmen | 132) 07/98 - 01/01 |
| 37) 01/86 - 01/01, rechter wiel, nuttige last 1000 Kg, 1300 Kg, Ch.244301- | 65) -2/85 | 133) 07/98 - 10/01, box, bus |
| | 66) 03/85- | 134) 07/98 - 10/01, box, dieplader |
| | 67) -17/11/93 | 135) 09/00 - 02/04, box, trommelremmen |
| | 68) 18/11/93- | 136) 09/00 - 02/04, box, schijfremmen |
| | 69) 10/87- | 137) 09/00 - 02/04, bus, trommelremmen |
| | 70) ABS | 138) 09/00 - 02/04, bus, schijfremmen |
| | 71) -12/92 | 139) 09/00 - 02/04, dieplader, trommelremmen |
| | 72) 01/93 - 17/08-98 | 140) 09/00 - 02/04, dieplader, schijfremmen |
| | 73) 01/77-14/03/84 | 141) 07/98 - 01/01, box, trommelremmen |
| | 74) 03/86- | 142) 07/98 - 01/01, box, schijfremmen |
| | 75) Behalve ABS. -08/91. Behalve "Trilex". | 143) 10/01 - 02/04, box, trommelremmen |
| | 76) ABS. -08/91. Behalve "Trilex". | 144) 10/01 - 02/04, box, schijfremmen |
| | 77) "Trilex"-20". -03/93. | 145) 07/98 - 01/01, bus, trommelremmen |
| | 78) "Trilex"-24". -03/93. | 146) 07/98 - 01/01, bus, schijfremmen |
| | 79) 09/91-03/93. Behalve "Trilex". | 147) 10/01 - 02/04, bus, trommelremmen |
| | 80) -2/86 | 148) 10/01 - 02/04, bus, schijfremmen |
| | 81) -12/87 | 149) 07/98 - 01/01, dieplader, trommelremmen |
| | 82) Borgmoer M75. -05/91 | 150) 07/98 - 01/01, dieplader, schijfremmen |
| | 83) Borgmoer M70.. -05/91 | 151) 10/01 - 02/04, dieplader, trommelremmen |
| | 84) Behalve ABS | 152) 10/01 - 02/04, dieplader, schijfremmen |
| | 85) Met ABS | 153) 07/98 - 10/01, box, trommelremmen |
| | 86) -05/95 | 154) 07/98 - 10/01, box, schijfremmen |
| | 87) 06/95- | 155) 07/98 - 10/01, dieplader, trommelremmen |
| | 88) -03/89 | 156) 07/98 - 10/01, dieplader, schijfremmen |
| | 89) 04/89- | 157) 10/03 - 02/04, box, trommelremmen |
| | 90) 1973-1989 | 158) 10/03 - 02/04, box, schijfremmen |
| | 91) Behalve motor G9T | 159) 10/03 - 02/04, bus, trommelremmen |
| | 92) Met motor G9T | 160) 10/03 - 02/04, bus, schijfremmen |
| | 96) 03/89 - 04/89, box, bus, binnenlager 35x72x24.5 mm | 161) 10/03 - 02/04, dieplader, trommelremmen |
| | 97) 03/89 - 04/89, box, bus, binnenlager 35x62x18.3 mm | 162) 10/03 - 02/04, Dieplader, schijfremmen |
| | 98) 05/89 - 10/97, dieplader | |
| | 100) 03/80 - 04/89, box, bus | |
| | 101) 03/80 - 04/89, dieplader | |
| | 102) 18/08/98 - | |
| | 103) - 31/03/98 | |
| | 104) 01/04/98 - | |
| | 105) - 27/08/98 | |
| | 106) - 24/08/98 | |
| | 107) - 17/08/98 | |
| | 108) Enkel wiel | |
| | 109) Tandem wiel | |
| | 110) 01/09/91 - 31/03/93 | |
| | 111) - 11/04/2000 | |
| | 112) 12/04/2000 - | |
| | 113) 03/80 - 04/89 | |

RVI

- 12) -14/06/85
- 13) 17/06/85-
- 14) -12/82
- 15) 01/83-
- 16) -15/11/85
- 17) 18/11/85-
- 18) -1986
- 19) 1987-
- 22) 07/86-
- 23) -14/03/84
- 24) 15/03/84-
- 25) 10/84-01/86
- 26) 02/86-
- 27) -09/84
- 28) -01/86
- 29) 10/84-
- 30) -09/83
- 31) 10/83-
- 33) -08/79
- 34) 09/79-
- 35) -08/84 MOT 62030
- 36) -12/83
- 37) 01/84-
- 38) -12/85
- 39) 01/86-
- 40) 12/92-
- 41) -05/91
- 42) 06/91-03/93
- 43) 04/93-
- 44) -08/84 MOT 62030. -N

SCANIA

- 1) Ch.-1032241
- 2) Ch.1032242-
- 3) Schijfwiels, ch.-1032241
- 4) Schijfwiels, ch.1032242-
- 5) Spaakwiel
- 6) Schijfwiels, ch.-1097602 SSS, ch.-4246024 SN
- 7) Schijfwiels, ch.1097603 SSS-, ch.4246025 SN-
- 8) Spaakwiel, ch.-1105665 SSS, ch.-4238514 SN



Opmerkingen

- 9) Spaakwiel , ch.1105666 SSS-, ch.4238515 SN-
- 10) Schijfwiel
- 11) Spaakwiel , chassis breedte 2300 mm
- 12) Spaakwiel 20"or 22.5"hub, ch.-1103187 SSS, ch.-4248317 SN
- 13) Spaakwiel 20"or 22.5"hub, ch.1103188 SSS-, ch.4248318 SN
- 14) Spaakwiel , 24"hub
- 15) Ch.-1097602 SSS, ch.-4246024 SN
- 16) Ch.1097603 SSS-, ch.4246025 SN-
- 17) Schijfwiel, ch.-1033747
- 18) Schijfwiel, ch.1033748-
- 19) Spaakwiel 20"or 22"hub, ch.-1103187 SSS, ch.-4248317 SN
- 20) Spaakwiel , 20"or 22"hub, ch.1033188 SSS-, ch.4248318 SN-
- 21) Schijfwiel, spaakwiel
- 22) Schijfwiel, (4x2, 6x2, 6x4)
- 23) Spaakwiel , (4x2, 6x2, 6x4) 20"or 22.5"hub
- 24) Spaakwiel , 24"hub. Remshoen 178 mm
- 25) Spaakwiel , 24"hub. Remshoen 203 mm
- 26) Tandem gestuurde as
- 27) Spaakwiel , 20", 22.5"or 24"hub
- 28) Zonder hub reductie
- 29) Met hub reductie
- 30) Schijfwiel, ch.-1029858
- 31) Schijfwiel, ch.1029859-
- 32) Schijfwiel, spaakwiel , 24"hub
- 33) Schijfwiel, spaakwiel , 20"or 22.5"hub
- 34) Schijfwiel, spaakwiel , 20", 22.5"or 24"hub
- 35) Schijfwiel, ch.-1161721 SSS, ch.-4292924 SN
- 36) Schijfwiel, ch.1161722 SSS-, ch.4292925 SN-
- 37) Schijfwiel, spaakwiel , 24"hub, ch.-1180029 SSS
- 38) Schijfwiel, spaakwiel , 24"hub, ch.1180030 SSS-
- 39) Schijfwiel, ch.-1850412
- 40) Schijfwiel, ch.1850413-
- 41) Bladveren oph. ch.-1801229
- 42) Bladveren oph. ch.1801230-
- 43) Luchtvering, ch.-1802872
- 44) Luchtvering, ch.1802873-
- 45) Ch.-1801229
- 46) Ch.1801230-
- 47) Schijfwiel, ABS/behalf ABS
- 48) ABS/behalf ABS
- 49) Luchtvering
- 50) Luchtvering. ABS
- 51) Luchtvering, trapeze vering
- 52) Luchtvering, trapeze vering. ABS
- 53) Schijfwiel, ch.-1871409
- 54) Ch.1871410-1871595
- 55) Ch.1871596-
- 56) Ch.1871410-
- 57) Remshoen 5"
- 58) Remshoen 7". Ch.1801196-
- 59) Ch.-1801195
- 60) Ch.1801196-
- 61) Ch.-1808231
- 62) Ch.1808232-
- 63) ABS/behalf ABS. Ch.-1808901, Ch.1808902
- 64) ABS/behalf ABS. Ch.-1806768, Ch.1806769-
- 65) Hub for de lengterichting geplaatste wielen
- 66) Schijfwiel, ABS/behalf. Ch.-1808901, Ch.1808902-
- 67) Luchtvering. 22.5"hub
- 68) Luchtvering. 22.5"hub. ABS
- 69) ABS
- 70) Hub 8.25 x 22.5"
- 71) Hub 8.25 x 22.5". ABS
- 72) Hub 9.00 x 22.5"
- 73) Hub 9.00 x 22.5". ABS
- 74) 6.5 tons
- 75) 6.5 tons. ABS
- 76) 7.1 tons
- 77) 7.1 tons. ABS
- 78) 6.5 tons. Ch.-1820117, Ch.1820118-
- 79) 6.5 tons. Ch.-1820117. ABS
- 80) 7.1 tons. Ch.-1820117
- 81) 7.1 tons. Ch.-1820117. ABS
- 82) ABS/behalf ABS. Ch.-1820117, Ch.1820118-
- 83) Luchtvering, ch.-1801229
- 84) Luchtvering, ch.1801230-1802872
- 85) Schijfwiel, behalf ABS, Ch.9015825 SAN-, Ch.4362206 SNL-, Ch.1226892 SSS-
- 86) Schijfwiel, ABS, Ch.9015825 SAN-, Ch.4362207 SNL-, Ch.1226892 SSS-
- 87) Spaakwiel , ABS/behalf ABS
- 88) Schijfwiel, ABS/behalf ABS, Ch.9015825 SAN-, Ch.4362207 SNL-, Ch.1226892 SSS-
- 89) Schijfwiel, behalf ABS, Ch.9015825 SAN-, Ch.4362207 SNL-, Ch.1226207 SSS-
- 90) Schijfwiel, behalf ABS
- 91) Schijfwiel, behalf ABS, RP/RBP 730
- 92) Behalf ABS, RP/RBP 832
- 93) Schijfwiel, ABS
- 94) Schijfwiel/spaakwiel , ABS/behalf ABS, Ch.9015825 SAN-, Ch.4362207 SNL-, Ch.1226892 SSS-
- 95) Spaakwiel , behalf ABS
- 96) Schijfwiel, Ch.1820118-, ABS
- 97) Schijfwiel, Ch.1820118-, behalf ABS
- 98) Tot Ch.nr. Scania Sodertalje 1242205, Scania Zwolle 4397541, Scania Angers 9034654, Scania Katrineholm 1833391
- 99) Schijfwiel, schijfremmen, ABS
- 100) Spaakwiel 22", 22.5"hub
- 101) RP/RBP 832
- 102) 22", 22.5", 24"hub
- 103) 20", 22.5"hub, RBP/RP730
- 104) 24"hub, RP/RBP 832
- 105) Schijfwiel Ch.-9015824 SAN, Ch.-4365570 SNL, Ch.-1226891 SSS
- 106) Schijfwiel, ABS, Ch.-9015824 SAN, Ch.-4362206 SNL, Ch.-1226891 SSS
- 107) Schijfwiel, schijfremmen, ABS/behalf ABS
- 4) 110 mm as, met remmen C3/C5 (80 tanden)

TRAILOR

- 1) 107, 6 mm as, met remmen CI/C2-
- 2) 110 mm as, met remmen D1/K1/H1
- 3) 110 mm as, met remmen C1/C2/L1/L2 (100 tanden)
- 4) 110 mm as, met remmen C3/C5 (80 tanden)

VOLKSWAGEN

- 1) 1976-96
- 5) Ch.21N-006786 -, 08/91-96, 22,5 mm borgring
- 7) Behalf tandem wiel. Ch.28G-015892 - 21N-006785, 04/86-07/91, 20 mm borgring
- 8) Behalf tandem wiel. Ch.21N-006786 -, 08/91-96, 22,5 mm borgring
- 9) Spraalveer, 1979-82
- 10) Bladveer, ch.-28-B-018540, 1979-81
- 11) Bladveer, ch.28-B-018541-, 1981-82
- 12) 1979-82
- 13) Ch.-28-B-019162, 1979-81
- 14) Ch.28-B-019163-, 1981-82
- 15) 1983-96
- 16) 3500 kg, 1983-96
- 17) 4000 kg, 1983-96
- 18) 1984-96
- 19) 05/96 - 10/04
- 20) 05/96 - 10/04, Mod. LT 28, LT 35
- 21) 05/96 - 10/04, Mod. LT 46
- 22) 08/67 - 07/79
- 23) 08/71 - 12/73
- 24) 08/75 - 07/79
- 25) 08/70 - 07/92
- 26) 08/79 - 12/82
- 27) 08/79 - 12/84, Ch.-24-E-023827
- 28) 01/84 - 07/92, Ch.24-E-023828 -
- 29) 10/86 - 07/92
- 30) 01/84 - 07/92, Ch.24-E-023828 -
- 31) 08/85 - 07/92
- 32) 11/84 - 07/92
- 33) 08/75 - 07/92
- 34) 07/90 - 10/04
- 35) 10/92 - 10/04
- 36) 07/90 - 10/04, 800-1200 Kg
- 37) 10/92 - 10/04, 800-1200 Kg
- 38) 04/03 - 09/04, Ch.-7 H-4-017500, 7J-4-017500
- 39) 07/04 - 09/04, Ch.-7 H-4-017500, 7J-4-017500
- 40) 04/03 - 10/04
- 41) 07/04 - 10/04

SMB

- 1) 107, 6 mm as, met remmen CI/C2-
- 2) 110 mm as, met remmen D1/K1/H1
- 3) 110 mm as, met remmen C1/C2/L1/L2 (100 tanden)

VOLVO

- 1) Hub 363067
- 2) 57 mm fusee
- 3) Ch.-20653
- 4) Schijfwiel, ch.20654-
- 5) Spaakwiel , ch.20654-

Opmerkingen

- 6) Schijfwiels, spaakwiel , -1503875
7) Spaakwiel , 1503876-
8) Zonder hub reductie, ch.36634-
9) Met hub reductie
10) Zonder hub reductie
11) Schijfwiels
12) Spaakwiel
13) Ch.-6997
14) Schijfwiels, ch.6998-
15) Spaakwiel , ch.6998-
16) Stiff springs
17) Zachte vering
18) Ch.-7050
19) Ch.7051-
20) Ch.-23510
21) Ch.23511-
22) Ch.-2376
23) Ch.2377-
24) Ch.-6450
25) Ch.6451-
26) Ch.-703
27) Ch.704-
28) Ch.-21671
29) Ch.21672-
30) Ch.-3145 (ong.)
31) Ch.3146 (ong.)-6871
32) Ch.6872-
33) Ch.-2728
34) Ch.2729-6871
35) ABS/behaltve ABS
36) Semi, starre as
37) Voor voertuigen met een vaste constructie
38) Voor voertuigen met een vaste constructie
39) Schijfwiels, bout cirkel diam. 335 mm
40) ABS/behaltve ABS. Schijfwiels, bout cirkel diam. 335 mm
41) Schijfwiel, ch.-27087
42) Schijfwiel, ch.27088-
43) Spaakwiel 20"hub, ch.-27087
44) Spaakwiel 22"hub, ch.-27087
45) Spaakwiel, ch.27088-
46) Spaakwiel 20"hub
47) Spaakwiel, zonder hub reductie
48) Schijfwiels, ch.-19745
49) Schijfwiels, ch.19746-
50) Met luchtvering en speciaal design
51) Met "S-ride" en enkel wiel
52) Schijfwiels, vroegere modellen
53) Spaakwiel , vroegere modellen
54) Constructie voertuig met rechte voortrein en heigh tened bodemspeling
55) Spaakwiel , ABS/behaltve ABS
56) Schijfwiels, ABS/behaltve ABS
57) Schijfwiels, BGT 18/21/26 met bladveren achterwielophanging
58) Schijfwiels, luchtvering, "S-ride", rear steer
59) Met luchtvering en rear steer
60) ABS/behaltve ABS, Met Bladveren oph.
61) Ch.-12099
62) Ch.12100-
63) Ch.12001-
64) Schijfwiels, ch.-11549
65) Schijfwiels, ch.11550-
66) Ch.-26821
67) Ch.26822-
68) Schijfwiels, ch.-40640, ABS/behaltve ABS
69) Spaakwiel 20"hub, zonder hub reductie
70) Spaakwiel 24"hub, zonder hub reductie
71) Schijfwiels, ch.-20876, ABS/behaltve ABS
72) Schijfwiels, ch.20877-, ABS/behaltve ABS
73) Schijfwiels, ch.25001-40640, bout cirkel diam. 335 mm
74) Spaakwiel 20"hub, ch.25001-40640
75) Spaakwiel 24"hub, ch.25001-40640
76) Met luchtvering, ch.-25000
77) S-ride, rear steer, ch.25001-40640
78) Schijfwiels, zonder hub reductie
79) Ch.-52439
80) Ch.52440-
81) Schijfwiels, ch.306000-, bout cirkel diam. 335 mm
82) Spaakwiel 20", 24"hub, ch.306000-
83) Schijfwiels, ch.306000-, ABS/behaltve ABS, bolt circle diam. 335
84) Schijfwiels, ch.-46315
85) Schijfwiels, ch.46316-, ABS/behaltve ABS
86) Spaakwiel 24"hub, ch.49001-
87) Schijfwiels 20", 22.5", 24"hub
88) Constructie voertuig met rechte voortrein
89) Spaakwiel 24"hub
90) Ch.-36763
91) Ch.36764-
92) Ch.-65820
93) Ch.-65820, Spaakwiel 20", 24"hub
94) Schijfwiels, zonder hub reductie
95) Schijfwiels, ch.-22914
96) Schijfwiels, ch.22915-
97) Spaakwiel 20"hub, ch.34001-
98) Spaakwiel 24"hub, ch.34001-
99) Met luchtvering
100) Speciaal modell, super volyme S-10609, S-10610, S-10801, S-11010, S-97024, S-97025, ch.314000-
101) Spaakwiel , 20", 24"hub
102) Spaakwiel , with single reduction
103) Tandem as met hub reductie
104) Enkel gemonteerde in de lengterichting geplaatste wielen, schijfwiel
105) Dubbel gemonteerde in de lengterichting geplaatste wielen, schijfwiel
106) Ch.-15169
107) Ch.15170-
108) Schijfwiels, ch.-8779
109) Schijfwiels, ch.8780-
110) Spaakwiel , ch.-12000
111) Spaakwiel 20"hub, ch.12001-
112) Spaakwiel 24" hub, ch.12001-
113) Spaakwiel 22", 22.5", 24"hub
114) Spaakwiel 20"hub, met bladveer oph, ABS/behaltve ABS
115) Spaakwiel 24"hub, met bladveer oph
116) Spaakwiel 20"hub, met luchtvering
117) Spaakwiel , ch.314000-, met luchtvering, rear
118) Speciaal modell, super volume; 1) S-10099, S-10365, S-10803, S-11011 2) S-10111, S-10112, S-97024, S-97025
119) Ch.7980
120) Ch.7981-
121) Ch.-3404
122) Ch.3405-7980
123) Ch.-5256
124) Ch.5257-
125) B 6F
126) B 6FA
127) Ch.865-. Behaltve Ch.873-875, oliegesmeerd
128) B 6F, B 609, B 610
129) B 6FA, ch.-404, hub 6772232
130) B 6FA, ch.405-
131) Ch.20000-
132) Ch.-10521. Vetgesmeerd
133) Ch.10522-. Oliegesmeerd
134) Vetgesmeerd, rear steer
135) Oliegesmeerd, rear steer ABS/behaltve ABS
136) Oliegesmeerd
137) Ch.-3906
138) Ch.3907-
139) Ch.4308-. ABS
140) Voortreinbelasting inbegrepen, FAT 5,0
141) CHID-B169140, sschijfwiels, bout cirkel diam. 335 mm
142) Behaltve ABS, schijfwiels, bout cirkel diam. 335 mm, disc
143) Hub 6774825. Voortreinbelasting inbegrepen, FAT 5,0
144) CHID -B170985
145) CHID B170986-
146) S-60677, S-60936
147) Schijfwiels, bout cirkel diam. 335 mm, met luchtvering.
148) Schijfwiels, bout cirkel diam. 335 mm, BAT 11,5 with leaf springs suspension
149) 6X2 TAG (HENDRICKSON)
150) 6774825, 6795568
151) Met. speciaal modell; S-60945, S-60990, S-60993, S-61208, S-61230
152) B 6FA, ch.-404. (Repl. 6772232, 6770991, 6771541, 960234, 6772691,95678, 18665. One pcs of each)
153) ABS/behaltve ABS. Ch.5000-
154) Ch.5000-
155) CHID.-A276505, -B190367, -563621
156) BAT 10.0 BAT 10.9 BAT 11,2
157) BAT 11,5 BLF-B BAT 13,0
158) BAT 11,5 LUF-B
159) Voortreinbelasting inbegrepen, FAT 4,7
160) WTT-D275
161) Ch.-A286102, -B207062, D120498



Jak korzystać z katalogu

Model samochodu	oś przednia/tylna	Opis osi	Skład zestawu	Zewnętrzne łożysko/uszczelniacz	Wewnętrzne łożysko/uszczelniacz	Typ łożyska	Zestaw uszczelniający	Uwagi
Przykład								
DAF			VKBA 5240					
Sherpa 285, 300, 310, 350	•				• VKHB 2237 • VKHB 2238	L 68149/110/Q 07087 X/ K-07210 X		
	○				• VKHB 2246 • VKHB 2239	18790/18720/Q 18690/18620/Q		2), 22)
Sherpa 285, 310, 350 (M1 21U)	•		VKBA 5240		• VKHB 2237 • VKHB 2238	L 68149/110/Q 07087 X/ K-07210 X		19), 21)
	○				• VKHB 2246 • VKHB 2239	18790/18720/Q 18690/18620/Q		2), 18)
F 400 Ser.	•	28 N	VKBA 5240		• VKHB 2237 • VKHB 2238	L 68149/110/Q 07087 X/ K-07210 X		













Skład zestawów

	A	B	C	D	E	F	G	H	I	J	K	L		
VKA 4004							1		1				VOLVO	• ○
VKA 4026							1		1				VOLVO	• ○
VKA 4036							2	1					SCANIA	• ○
VKA 4038							1	1					SCANIA	• ○
VKA 4094							2	1					MERCEDES-BENZ	• ○
VKA 4095							1	2					MERCEDES-BENZ	• ○

A	B	C	D	E	F	G	H	I	J	K	L	

Typ łożyska Podkładka zabezpieczająca Nakrętka Tulejka dystansowa Pierścień blokujący Pierścień ustalający Uszczelka Uszczelka Uszczelka Płytko osłonowa Zawleczka Pozostałe części

VKBA = VKHB + VKHB + VKA/VKS

						
						
VKBA 5025 VKBA 5027	VKHB 2056 VKHB 2059	VKHB 2057 VKHB 2007	VKS 6299 ...			

Lista zamienniki z oznaczeń producenta na SKF

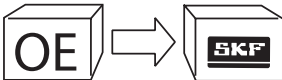
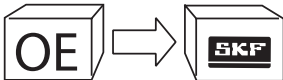
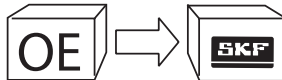
		
BPW		FIAT / IVECO
02.5664.26.57 02.5664.46.57 02.5664.55.57	0174592 0174595 0190069 0221664 0266487	1101597 1102042
VKS 6285 VKS 6287 VKS 6250 VKS 6251	VKHB 2043 VKHB 2141 VKS 6171 VKHB 2222 VKHB 2223	VKHB 2060 VKHB 2282 VKHB 2283



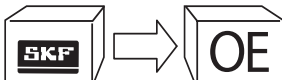
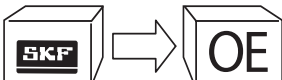

Lista zamienniki z oznaczeń SKF na producenta

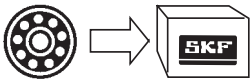
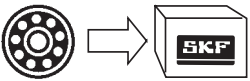
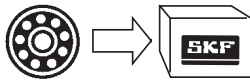
	
VKBA 519	VKBA 3616
VW VW FORD FORD MERCEDES BENZ	RENAULT / RVI OPEL OPEL FIAT / IVECO
211 498 071 211 498 071 BS 5 007 029 5 007 028 111 220 00 51	77 01 206 742 44 08 669 91160087 77 01 206 848 110 20 27

Łożysko - SKF VKHB

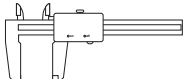
		
07087 X/K-07210 X 108 221 10	VKHB 2238 VKHB 2268 VKHB 2269	VKHB 2175 VKHB 2176
32310 TN9 32311 12	VKHB 2303 VKHB 2304	32310/39520/Q

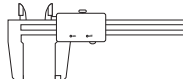
Wymiary uszczelniacz

					
d	D	W	d	D	W
44,0 53,0	85,0 97,0	10,0/8,0 8,0 12,0	VKS 6229 VKS 6219	117,4 118,0	142,8 142,8
					12,7 27,0
					VKS 6108 VKS 6109



Symbole

Symbole używane w części katalogowej



Nowe zestawy lub zamienniki



Ciągnarówki



Autobusy



Naczepy



Skład zestawów



VKBA=VKHB+VKHB+VKA/VKS



Lista zamienniki z oznaczeń producenta na SKF



Lista zamienniki z oznaczeń SKF na producenta



Łożysko - SKF VKHB



Wymiary uszczelnacza

Symbole uniwersalne

->| Aż do

|-> Od



Zestawy zastąpione



Zestawy wycofane



Narzędzia

Skróty

CH	Numer podwozia
Forward rear axle	Przednia oś tylnego mostu
Rear rear axle	Tylna oś tylnego mostu
Trailing axle	Oś wleczona

VKBA XXXX	Oferowane
VKHB XXXX	Oferowane
VKA XXXX	Oferowane
VKS XXXX	Oferowane
VKN XXX	Oferowane

Uwagi

BPW

- 1) Niski załadunek
- 2) Oprócz modeli niskiego załadunku

CITROËN

- 1) 09/81 - 12/89, Ch.-604496
- 2) 01/89 - 03/04, Ch.604497 -
- 3) 02/91 - 03/94
- 4) 01/87 - 12/89, Ch.-604496
- 5) 01/89 - 02/94, Ch. 604497 -
- 6) 09/81 - 12/86, lewe koło, Ch.-289710, ładowność : 1000, 1300 Kg
- 7) 09/81 - 12/86, prawe koło, Ch.-289710, ładowność : 1000, 1300 Kg
- 8) 09/81 - 03/94, lewe koło, ładowność :1800 Kg
- 9) 09/81 - 03/94, prawe koło, ładowność : 1800 Kg
- 10) 01/86 - 03/94, lewe koło, Ch.289711-, ładowność : 1000, 1300, 1400 Kg
- 11) 01/86 - 03/94, prawe koło, Ch.289711-, ładowność : 1000, 1300, 1400 Kg
- 12) 01/87 - 02/94,
- 13) 02/94 - 04/02, Ch.-16194399, ładowność :1000, 1400 Kg
- 14) 02/94 - 04/02, Ch.-16194399, ładowność : 1800 Kg
- 15) 02/94 - 04/02, Ch.16194400 -, ładowność : 1000, 1400 Kg
- 16) 02/94 - 04/02, Ch.16194400 -, ładowność : 1800 Kg
- 17) 04/02 - 09/04, ładowność : 1000, 1400 Kg
- 18) 04/02 - 09/04, ładowność : 1800 Kg
- 19) 03/94 - 04/02, Ch.-16194399, ładowność : 1000, 1400 Kg
- 20) 03/94 - 04/02, Ch.-16194399, ładowność : 1800 Kg
- 21) 03/94 - 04/02, Ch.16194400 -, ładowność : 1000, 1400 Kg
- 22) 03/94 - 04/02, Ch.16194400 -, ładowność : 1800 Kg
- 23) 08/96 - 04/02, Ch.-16194399, ładowność : 1000, 1400 Kg
- 24) 08/96 - 04/02, Ch.-16194399, ładowność : 1800 Kg
- 25) 08/96 - 04/02, Ch.16194400 -, ładowność : 1000, 1400 Kg
- 26) 08/96 - 04/02, Ch.16194400 -, ładowność : 1800 Kg
- 27) 02/94 - 04/02, Ch.16194400 -
- 28) Hamulce bębnowe
- 29) Hamulce tarczowe

DAF

- 2) Podwójne koło tylne
- 3) Rozstaw kół 1655 mm, z 10 śrubową piastą
- 4) Rozstaw kół 1655 mm, z 8 śrubową piastą
- 5) Oprócz centralnej piasty
- 6) Z centralną piastą
- 7) Z centralną piastą. Czarny uszczelniacz
- 8) Z centralną piastą. Niebieski uszczelniacz
- 9) Z reduktorem
- 10) Oprócz FAR

- 11) Z FAR
- 12) Oprócz FA, FT
- 13) Z FA, FT
- 14) Oprócz centralnej piasty
- 15) Oprócz centralnej piasty
- 16) Czarny uszczelniacz
- 17) Niebieski uszczelniacz
- 18) 1983-85
- 19) Ch.237886-, pojedyncze tylne koło
- 21) 1984-85
- 22) 1985-12/89
- 23) -12/89
- 24) Uszczelniacz olejowy/Pierścień ABS - nie zintegrowany

FIAT-IVECO

- 4) Lewe koło
- 5) Prawe koło
- 8) Lewe koło, 06/79-06/81
- 9) Prawe koło, 06/79-06/81
- 10) 10/77-06/81
- 11) Lewe koło, 06/81-09/84
- 12) Prawe koło, 06/81-09/84
- 13) 06/81-09/84
- 14) Lewe koło, 10/84-88
- 15) Prawe koło, 10/84-88
- 16) 10/84-88
- 17) 03/85-88
- 18) Ch.-604496, 1982-89
- 19) Ch.604497-, 1989-93
- 20) Lewe koło, ch.-278757, 1982-86
- 21) Prawe koło, ch.-278757, 1982-86
- 22) Lewe koło, ch.278758-, 1986-93
- 23) Prawe koło, ch.278758-, 1986-93
- 24) 1982-86
- 25) Ch.-604496, 1986-89
- 26) Lewe koło, 1986-93
- 27) Prawe koło, 1986-93
- 28) 10/77-12/86
- 29) 01/87-
- 30) Oprócz 50-9 D, 50-9 V
- 31) 04/91-04/92
- 32) 01/85-
- 33) Hamulce tarczowe
- 34) 12/85-
- 36) 1991-94
- 37) Lewe koło, 1991-94
- 38) Prawe koło, 1991-94
- 39) Oprócz ABS
- 40) Oprócz modeli na rynek Szwajcarski
- 41) Modele na rynek Szwajcarski
- 42) Przełożenie główne 4.23/1
- 43) Oprócz przełożenia głównego 4.23/1
- 44) Przełożenie główne 4.23/1. Oprócz modeli na rynek Szwajcarski
- 45) Oprócz przełożenia głównego 4.23/1. Oprócz modeli na rynek Szwajcarski
- 46) Oprócz przełożenia głównego 3.79/1
- 47) Przełożenie główne 3.79/1
- 48) CH. -173788
- 49) Ch.173789-. oś -1824487
- 50) Ch.173789-. oś 1824488-
- 51) Ch.173789-
- 52) Wymiary wew. średnicy łożyska 95 mm
- 53) Wymiary wew. średnicy łożyska 105 mm. Oś -1824487

- 54) Wymiary wew. średnicy łożyska 105 mm. Oś 1824488-
- 55) Oś skrętna. Oś sztywne, kod części 7177196
- 56) Oś sztywne, kod części 7177168
- 57) Wymiary wew. średnicy łożyska 100 mm
- 58) Oś -1824487
- 59) Oś 1824488-
- 60) Lewe koło, 06/79-01/97
- 61) Prawe koło, 06/79-01/97
- 62) 06/81-01/97
- 63) Lewe koło, 06/81-88
- 64) Prawe koło, 06/81-88
- 65) Oprócz napędzanych przednich kół 5.22/1. -02/96
- 66) Przełożenie główne 5.22/1. -02/96
- 67) Lewe koło, 06/79-02/96
- 68) Prawe koło, 06/79-02/96
- 69) 10/77-09/84
- 70) Oprócz: "Iveco check control"
- 71) "Iveco check control"
- 72) Lewe koło, -02/96
- 73) Prawe koło, -02/96
- 74) -2/96
- 75) Przełożenie główne 5.62/1
- 76) Oprócz napędzanych przednich kół 5.62/1
- 77) ABS
- 78) Lewe koło, 03/85-88
- 79) Prawe koło, 03/85-88
- 81) 02/96
- 82) 03/96-
- 83) 1994-
- 84) 1996-
- 85) Łożysko stożkowe jednorzędowe
- 86) Łożysko stożkowe dwurzędowe
- 87) Oś sztywne
- 88) Oś skrętna
- 89) Napęd przedni
- 90) Oprócz napędzanych przednich kół
- 91) Prawe przednie koło łożysko stożkowe jednorzędowe, 03/96 - 12/99
- 92) Prawe przednie koło łożysko stożkowe jednorzędowe, 03/96 - 12/99
- 93) Łożysko stożkowe dwurzędowe, 03/96 - 12/99
- 94) Up to 05/89
- 95) 06/89 - 01/97
- 96) 01/96 - 12/99
- 97) Up to 12/99
- 98) 05/99 - 08/03
- 99) 06/81 - 01/97
- 100) 04/02 - 01/04
- 101) 07/02 - 01/04
- 102) Ładowność 1100, 1500 Kg
- 103) Ładowność 1800 Kg

FORD

- 1) 1965-91
- 2) 07/74-12/77
- 3) 08/65-12/77
- 6) 11/73-12/77
- 7) 01/78-10/85
- 8) Lewe koło, 11/85-91
- 9) Prawe koło, 11/85-91
- 10) 11/85-91
- 11) 1992-97
- 12) 01/81-03/87



Uwagi

- 13) 03/87-12/92
- 14) 04/82 - 09/87
- 15) 10/87 - 12/90 lewe koło
- 16) 10/87 - 12/90 prawe koło
- 18) 01/00 - 10/04
- 19) 01/00 - 10/04, oprócz ABS, ładowność 1000 Kg, FWD
- 20) 01/00 - 10/04, ABS, ładowność 1000 Kg, FWD
- 21) 07/03 - 10/04, oprócz ABS, ładowność 2000 Kg, FWD
- 22) 07/03 - 10/04, ABS, ładowność 2000 Kg, FWD
- 23) 01/00 - 10/04, pojedyncze koło, RWD
- 24) 01/00 - 10/04, koła typu "bliźniak", RWD
- 25) 03/04 - 10/04, oprócz ABS, ładowność 2000 Kg
- 26) 03/04 - 10/04, ABS, ładowność 2000 Kg

FRUEHAUF

- 1) 107, 6 mm oś z hamulcami C1/C2
- 2) 110 mm oś z hamulcami D1/K1/H1
- 3) 110 mm oś z hamulcami C1/C2/L1/L2 (100 zębów)
- 4) 110 mm oś z hamulcami C3/C5 (80 zębów)

GIGANT (SAE)

- 1) Zawieszenie pneumatyczne typu N
- 2) Protec oś

MAN

- 1) -11/93
- 2) 12/93-
- 3) W25/86-W27/90
- 4) W28/90-
- 5) Oprócz ABS
- 6) ABS
- 7) 01/90-
- 8) Piastą. 81.35701.0081
- 9) Piastą. 81.35701.0127
- 10) 20" TRILEX
- 11) Piastą. 81.35701.0141
- 12) Oprócz "TRILEX"
- 13) "TRILEX"
- 14) -W18/94
- 15) W19/94-
- 16) -W27/96
- 17) W28/96-, 19.5" piastą
- 18) W28/96-, 20/22.5" piastą

MERCEDES-BENZ

- 1) 02/88 - 02/96
- 2) 02/88 - 02/96, Ch.-128165
- 3) 1983-94
- 4) Ch.-48630
- 5) Ch.48631-
- 6) Silnik diesla ch.-17768, silnik benzynowy ch.-1288

- 7) Silnik diesla ch.17768-78114, silnik benzynowy ch.1289-4706
- 8) Silnik diesla ch.78115-, silnik benzynowy ch.4707-
- 9) Wymiary wew. średnicy łożyska 55 mm
- 10) Oś -1358880
- 11) Oś 1358881-
- 12) 02/88 - 02/96, Ch.128166-
- 13) C -1278813
- 14) Oś 1278814-
- 15) 02/88 - 05/92, pickup
- 16) 02/73 - 12/77
- 17) 01/95 - 05/02, aż do os: S213915/Y245976
- 18) 01/95 - 05/02
- 19) Oś -1390839
- 20) Oś 1390840-
- 21) Oś -1278313
- 22) Oś 1278314-
- 23) 02/95 - 07/04, to os: S231915/Y245976
- 24) Hamulce bębnowe
- 25) Z ABS, oś -021298
- 26) Z ABS, oś 021299-
- 27) Oś -724723
- 28) Oś 724724-
- 29) Piasta: 355 356 44 01
- 30) Piasta: 346 356 30 01
- 31) 02/95 - 07/04
- 32) 02/96 - 05/02, aż do os: S231915/Y245976
- 33) 02/96 - 05/02,
- 34) 09/96 - 07/04
- 35) 02/96 - 07/04
- 37) Piasta: 668 356 01 01, 668 356 02 01
- 38) Piasta: 972 356 01 01
- 39) Piasta: 976 356 11 01
- 40) Piasta: 678 356 04 01
- 41) Piasta: 675 356 01 01
- 42) Hamulce tarczowe
- 43) Piasta: 942 334 08 01
- 44) Piasta: 942 334 07 01, 949 334 05 01

MERITOR (ROR)

- 1) Smarowanie smarem

MONTENEGRO

- 1) Oś 061001243, 061001243A
- 2) Oś 06-1-1068
- 3) Oś 06-1-1176, 061001231
- 4) Oś 061001271
- 5) Oś 061001231A
- 6) Oś 061001230, 061001230A
- 7) Oś 06-1-1025
- 8) Oś 061001170A
- 9) Oś 061001299
- 10) Oś 061001210, 061001210B, 061001295
- 11) Oś 06-1-1103, 06-1-1170
- 12) Oś 06-1-1100, 06-1-1102, 06-1-1106, 06-1-1108, 06-1-1173, 06-1-1174

OPEL

- 1) 09/00 - 10/01, rozstaw kół (w calach);15, Ch.-B 000010, numer silnika:F9Q-770

- 2) 09/00 - 10/01, rozstaw kół (w calach);15, Ch. B 000011-, numer silnika: F9Q-770
- 3) 07/98 - 10/01, rozstaw kół (w calach);16
- 4) 07/98 - 10/01, pickup, rozstaw kół (w calach);15, Ch.-B 0000514, B 006055, numer silnika: S8U-702
- 5) 07/98 - 10/01, bus, zabudowany, Dumpertruck, rozstaw kół (w calach); 15, Ch.-B 051615, numer silnika: S9W-702
- 6) 07/98 - 10/01, pickup, rozstaw kół (w calach);15, Ch.B 0000515-, B 006056-, numer silnika: S8U-702
- 7) 07/98 - 10/01, bus, zabudowany, Dumpertruck, rozstaw kół (w calach);15, Ch.B 051616-, numer silnika: S9W-702
- 8) 07/98 - 10/01, rozstaw kół (w calach);15
- 9) 07/98 - 10/01, rozstaw kół (w calach);16
- 10) 08/01 - 08/05, oprócz ABS, Ch.- 3V613233
- 11) 08/01 - 08/05, z ABS, Ch.- 3V613233
- 13) 08/01 - 08/05

PEUGEOT

- 1) 01/83 - 11/88
- 2) 10/90 - 01/01
- 3) 09/81 - 12/89, Ch.-604496
- 4) 01/89 - 09/90, Ch.604497-
- 5) 09/81 - 12/85, lewe koło, ładowność 1000 Kg, 1300 Kg, Ch.-244300
- 6) 09/81 - 01/01, lewe koło, ładowność 1400 Kg
- 7) 09/81 - 01/01, lewe koło, ładowność 1800 Kg
- 8) 09/81 - 01/01, prawe koło, ładowność 1400 Kg
- 9) 09/81 - 01/01, prawe koło, ładowność 1800 Kg
- 10) 01/86 - 11/88, lewe koło, ładowność 1000 Kg, 1300 Kg, Ch. 244301-
- 11) 09/81 - 12/85, prawe koło, ładowność 1000 Kg, 1300 Kg, Ch.-244300
- 12) 01/86 - 11/88, prawe koło, ładowność 1000 Kg, 1300 Kg, Ch.244301-
- 13) 10/90 - 01/01, lewe koło, ładowność 1000 Kg, 1300 Kg
- 14) 10/90 - 01/01, prawe koło, ładowność 1000 Kg, 1300 Kg
- 15) 1967-09/70
- 16) 10/70-80
- 17) 1967-80
- 18) 1980-88
- 19) 03/94 - 04/02, ładowność 1000 Kg, 1400 Kg, Ch.-16194399
- 20) 03/94 - 04/02, ładowność 1800 Kg, Ch.-16194399
- 21) 03/94 - 04/02, ładowność 1000 Kg, 1400 Kg, Ch.16194400-
- 22) 03/94 - 04/02, ładowność 1800 Kg, Ch.16194400-
- 23) 04/02 - 07/04, ładowność 1000 Kg, 1400 Kg
- 24) 04/02 - 07/04, ładowność 1800 Kg
- 25) 07/96 - 04/02, ładowność 1000 Kg, 1400 Kg, Ch.-16194399
- 26) 07/96 - 04/02, ładowność 1800 Kg, Ch.-16194399
- 27) 07/96 - 04/02, ładowność 1000 Kg, 1400 Kg, Ch.16194400-

Uwagi

- 28) 07/96 - 04/02, ładowność 1800 Kg, Ch.16194400-
29) 03/04 - 04/02, Ch.16194400-
30) 04/02 - 07/04
31) 10/01 - 04/02
32) 11/00 - 09/01, ładowność 1000 Kg, 1400 Kg
33) 11/00 - 09/01, ładowność 1800 Kg
34) 07/96 - 04/02, hamulce bębnowe
35) 07/96 - 04/02, hamulce tarczowe
36) 01/86 - 01/01, lewe koło, ładowność 1000 Kg, 1300 Kg, Ch.244301-
37) 01/86 - 01/01, prawe koło, ładowność 1000 Kg, 1300 Kg, Ch.244301-
- 66) 03/85-
67) -17/11/93
68) 18/11/93-
69) 10/87-
70) ABS
71) -12/92
72) 01/93 - 17/08-98
73) 01/77-14/03/84
74) 03/86-
75) Oprócz: ABS. -08/91. Oprócz: "Trilex".
76) ABS. -08/91. Oprócz: "Trilex".
77) "Trilex"-20". -03/93.
78) "Trilex"-24". -03/93.
79) 09/91-03/93. Oprócz: "Trilex".
80) -2/86
81) -12/87
82) Nakretka blokująca M75. -05/91
83) Nakretka blokująca M70. -05/91
84) Oprócz: ABS
85) Z ABS
86) -05/95
87) 06/95-
88) -03/89
89) 04/89-
90) 1973-1989
91) Oprócz silnika G9T
92) W silnikiem G9T
96) 03/89 - 04/89, bus, zabudowany, wewnętrzne łożysko 35x72x24.5 mm
97) 03/89 - 04/89, bus, zabudowany, wewnętrzne łożysko 35x62x18.3 mm
98) 05/89 - 10/97, pickup
100) 03/80 - 04/89, bus, zabudowany
101) 03/80 - 04/89, pickup
102) 18/08/98 -
103) - 31/03/98
104) 01/04/98 -
105) - 27/08/98
106) - 24/08/98
107) - 17/08/98
108) Pojedyncze koło
109) Koła typu "bliźniak"
110) 01/09/91 - 31/03/93
111) - 11/04/2000
112) 12/04/2000 -
113) 03/80 - 04/89
114) 03/80 - 12/83, bus, zabudowany
115) 03/80 - 02/89
116) 01/84 - 12/85, bus, zabudowany
117) 01/86 - 02/89, bus, zabudowany
118) 03/89 - 04/89
119) 05/89 - 01/01, bus, zabudowany
120) 05/89 - 01/01
121) 05/89 - 01/01, pickup, typ:PC
122) 05/89 - 01/01, bus, zabudowany, wewnętrzne łożysko 35x72x24.5 mm
123) 05/89 - 01/01, bus, zabudowany, wewnętrzne łożysko 35x62x18.3 mm
124) 03/01 - 11/02, oprócz: ABS
125) 03/01 - 11/02, z ABS
126) 11/02 - 02/04
127) 03/01 - 02/04
128) 08/80 - 07/98, bus, zabudowany
129) 09/80 - 07/98, pickup
130) 07/98 - 03/00
131) 03/00 - 02/02
132) 07/98 - 01/01
133) 07/98 - 10/01, bus, zabudowany
134) 07/98 - 10/01, zabudowany, pickup
- 135) 09/00 - 02/04, zabudowany, Hamulce bębnowe
136) 09/00 - 02/04, zabudowany, hamulce tarczowe
137) 09/00 - 02/04, bus, hamulce bębnowe
138) 09/00 - 02/04, bus, hamulce tarczowe
139) 09/00 - 02/04, pickup, hamulce bębnowe
140) 09/00 - 02/04, pickup, hamulce tarczowe
141) 07/98 - 01/01, zabudowany, Hamulce bębnowe
142) 07/98 - 01/01, zabudowany, hamulce tarczowe
143) 10/01 - 02/04, zabudowany, Hamulce bębnowe
144) 10/01 - 02/04, zabudowany, hamulce tarczowe
145) 07/98 - 01/01, bus, hamulce bębnowe
146) 07/98 - 01/01, bus, hamulce tarczowe
147) 10/01 - 02/04, bus, hamulce bębnowe
148) 10/01 - 02/04, bus, hamulce tarczowe
149) 07/98 - 01/01, pickup, hamulce bębnowe
150) 07/98 - 01/01, pickup, hamulce tarczowe
151) 10/01 - 02/04, pickup, hamulce bębnowe
152) 10/01 - 02/04, pickup, hamulce tarczowe
153) 07/98 - 10/01, zabudowany, hamulce bębnowe
154) 07/98 - 10/01, zabudowany, hamulce tarczowe
155) 07/98 - 10/01, pickup, hamulce bębnowe
156) 07/98 - 10/01, pickup, hamulce tarczowe
157) 10/03 - 02/04, zabudowany, hamulce bębnowe
158) 10/03 - 02/04, zabudowany, hamulce tarczowe
159) 10/03 - 02/04, bus, hamulce bębnowe
160) 10/03 - 02/04, bus, hamulce tarczowe
161) 10/03 - 02/04, pickup, hamulce bębnowe
162) 10/03 - 02/04, pickup, hamulce tarczowe

RVI

- 12) -14/06/85
13) 17/06/85-
14) -12/82
15) 01/83-
16) -15/11/85
17) 18/11/85-
18) -1986
19) 1987-
22) 07/86-
23) -14/03/84
24) 15/03/84-
25) 10/84-01/86
26) 02/86-
27) -09/84
28) -01/86
29) 10/84-
30) -09/83
31) 10/83-
33) -08/79
34) 09/79-
35) -08/84 MOT 62030
36) -12/83
37) 01/84-
38) -12/85
39) 01/86-
40) 12/92-
41) -05/91
42) 06/91-03/93
43) 04/93-
44) -08/84 MOT 62030. -N
45) -08/84 MOT 62030. N 1540
47) 09/93-
48) Oprócz ABS. -08/91
49) ABS. -08/91
50) 09/91-03/93
51) 09/91-
52) -03/93
53) -08/91
54) -07/90
55) 08/90-
56) -02/91
57) 03/91-
58) -09/90
59) -02/92
60) 03/92-
61) -05/95
62) 06/95-
63) Hamulce bębnowe
64) Hamulce tarczowe
65) -2/85

SCANIA

- 1) Ch.-1032241
2) Ch.1032242-
3) Tarcza koła, ch.-1032241
4) Tarcza koła, ch.1032242-
5) Koło szprychowes
6) Tarcza koła, ch.-1097602 SSS, ch.-4246024 SN
7) Tarcza koła, ch.1097603 SSS-, ch.4246025 SN-
8) Koło szprychowes, ch.-1105665 SSS, ch.-4238514 SN
9) Koło szprychowes, ch.1105666 SSS-, ch.4238515 SN-
10) Tarcza koła
11) Koło szprychowes, chassis width 2300 mm
12) Koło szprychowes 20" or 22.5" piastą, ch.-1103187 SSS, ch.-4248317 SN
13) Koło szprychowes 20" or 22.5" piastą, ch.1103188 SSS-, ch.4248318 SN
14) Koło szprychowes, 24" piastą
15) Ch.-1097602 SSS, ch.-4246024 SN
16) Ch.1097603 SSS-, ch.4246025 SN-
17) Tarcza koła, ch.-1033747
18) Tarcza koła, ch.1033748-
19) Koło szprychowes 20" or 22" piastą, ch.-1103187 SSS, ch.-4248317 SN



Uwagi

- 20) Koło szprychowes, 20" or 22" piastą, ch.1033188 SSS-, ch.4248318 SN-
- 21) Tarcza koła, Koło szprychowes
- 22) Tarcza koła, (4x2, 6x2, 6x4)
- 23) Voło szprychowes, (4x2, 6x2, 6x4) 20" or 22,5" piastą
- 24) Voło szprychowes, 24" piastą, Szczęka hamulcowa 178 mm
- 25) Voło szprychowes, 24" piastą, Szczęka hamulcowa 178 mm
- 26) Podwójna oś skrętna
- 27) Koło szprychowes, 20", 22,5" or 24" piastą
- 28) Bez reduktora
- 29) Z reduktorem
- 30) Tarcza koła, ch.-1029858
- 31) Tarcza koła, ch.1029859-
- 32) Tarcza koła, Koło szprychowes, 24" piastą
- 33) Tarcza koła, Koło szprychowes, 20" or 22,5" piastą
- 34) Tarcza koła, koło szprychowes, 20", 22,5" or 24" piastą
- 35) Tarcza koła, ch.-1161721 SSS, ch.-4292924 SN
- 36) Tarcza koła, ch.1161722 SSS-, ch.4292925 SN-
- 37) Tarcza koła, Koło szprychowes, 24" piastą, ch.-1180029 SSS
- 38) Tarcza koła, Koło szprychowes, 24" piastą, ch.1180030 SSS-
- 39) Tarcza koła, ch.-1850412
- 40) Tarcza koła, ch.1850413-
- 41) Zawieszenie na resorach piórowych, ch.-1801229
- 42) Zawieszenie na resorach piórowych, ch.1801230-
- 43) Zawieszenie pneumatyczne, ch.-1802872
- 44) Zawieszenie pneumatyczne, ch.1802873-
- 45) Ch.-1801229
- 46) Ch.1801230-
- 47) Tarcza koła, ABS/oprócz ABS
- 48) ABS/oprócz ABS
- 49) Zawieszenie pneumatyczne
- 50) Zawieszenie pneumatyczne, ABS
- 51) Zawieszenie pneumatyczne, trapeze suspension
- 52) Zawieszenie pneumatyczne, zawieszenie trapezowe, ABS
- 53) Tarcza koła, ch.-1871409
- 54) Ch.1871410-1871595
- 55) Ch.1871596-
- 56) Ch.1871410-
- 57) Szczęka hamulcowa 5"
- 58) Szczęka hamulcowa 7". Ch.1801196-
- 59) Ch.-1801195
- 60) Ch.1801196-
- 61) Ch.-1808231
- 62) Ch.1808232-
- 63) ABS/oprócz ABS, Ch.-1808901, Ch.1808902
- 64) ABS/oprócz ABS, Ch.-1806768, Ch.1806769-
- 65) Piasta oś wleczona,
- 66) Tarcza koła, ABS/oprócz, Ch.-1808901, Ch.1808902-
- 67) Zawieszenie pneumatyczne, 22,5" piastą
- 68) Zawieszenie pneumatyczne, 22,5" piastą, ABS
- 69) ABS
- 70) Piasta 8.25 x 22.5"
- 71) Piasta 8.25 x 22.5". ABS
- 72) Piasta 9.00 x 22.5"
- 73) Piasta 9.00 x 22.5". ABS
- 74) 6.5 tons
- 75) 6.5 tons, ABS
- 76) 7.1 tons
- 77) 7.1 tons, ABS
- 78) 6.5 tons, Ch.-1820117, Ch.1820118-
- 79) 6.5 tons, Ch.-1820117, ABS
- 80) 7.1 tons, Ch.-1820117
- 81) 7.1 tons, Ch.-1820117, ABS
- 82) ABS/oprócz ABS, Ch.-1820117, Ch.1820118-
- 83) Zawieszenie pneumatyczne, ch.-1801229
- 84) Zawieszenie pneumatyczne, ch.1801230-1802872
- 85) Tarcza koła, oprócz ABS, Ch.9015825 SAN-, Ch.4362206 SNL-, Ch.1226892 SSS-
- 86) Tarcza koła, ABS, Ch.9015825 SAN-, Ch.4362207 SNL-, Ch.1226892 SSS-
- 87) Koło szprychowes, ABS/oprócz ABS
- 88) Tarcza koła, ABS/oprócz ABS, Ch.9015825 SAN-, Ch.4362207 SNL-, Ch.1226892 SSS-
- 89) Tarcza koła, oprócz ABS, Ch.9015825 SAN-, Ch.4362207 SNL-, Ch.1226207 SSS-
- 90) Tarcza koła, oprócz ABS
- 91) Tarcza koła, oprócz ABS, RP/RBP 730
- 92) Oprócz ABS, RP/RBP 832
- 93) Tarcza koła, ABS
- 94) Tarcza koła/koło szprychowes, ABS/oprócz ABS, Ch.9015825 SAN-, Ch.4362207 SNL-, Ch.1226892 SSS-
- 95) Koło szprychowes, oprócz ABS
- 96) Tarcza koła, Ch.1820118-, ABS
- 97) Tarcza koła, Ch.1820118-, oprócz ABS
- 98) Az do Ch.nr: Scania Sodertalje 1242205, Scania Zwolle 4397541, Scania Angers 9034654, Scania Katrineholm 1833391
- 99) Tarcza koła, Disc brake, ABS
- 100) Koło szprychowes 22", 22,5" piastą
- 101) RP/RBP 832
- 102) 22", 22,5", 24" piastą
- 103) 20", 22,5" piastą, RBP/RP730
- 104) 24" piastą, RP/RBP 832
- 105) Tarcza koła Ch.-9015824 SAN, Ch.-4365570 SNL, Ch.-1226891 SSS
- 106) Tarcza koła, ABS, Ch.-9015824 SAN, Ch.-4362206 SNL, Ch.-1226891 SSS
- 107) Tarcza koła, hamulce tarczowe, ABS/oprócz ABS

SMB

- 1) 107, 6 mm oś z hamulcami C1/C2
- 2) 110 mm oś z hamulcami D1/K1/H1
- 3) 110 mm oś z hamulcami C1/C2/L1/L2 (100 zębów)
- 4) 110 mm oś z hamulcami C3/C5 (80 zębów)

TRAILOR

- 1) 107, 6 mm oś z hamulcami C1/C2
- 2) 110 mm oś z hamulcami D1/K1/H1
- 3) 110 mm oś z hamulcami C1/C2/L1/L2 (100 zębów)
- 4) 110 mm oś z hamulcami C3/C5 (80 zębów)

VOLKSWAGEN

- 1) 1976-96
- 5) Ch.21N-006786 -, 08/91-96, z pierścieniem blokującym 22,5 mm
- 7) Oprócz koła typu "bliźniak" Ch.28G-015892 - 21N-006785, 04/86-07/91, z pierścieniem blokującym 20 mm
- 8) Oprócz koła typu "bliźniak". Ch.21N-006786 -, 08/91-96, 22,5 mm locking
- 9) Spreżyna, 1979-82
- 10) Resor piórowy, ch.-28-B-018540, 1979-81
- 11) Resor piórowy, ch.28-B-018541-, 1981-82
- 12) 1979-82
- 13) Ch.-28-B-019162, 1979-81
- 14) Ch.28-B-019163-, 1981-82
- 15) 1983-96
- 16) 3500 kg, 1983-96
- 17) 4000 kg, 1983-96
- 18) 1984-96
- 19) 05/96 - 10/04
- 20) 05/96 - 10/04, Mod. LT 28, LT 35
- 21) 05/96 - 10/04, Mod. LT 46
- 22) 08/67 - 07/79
- 23) 08/71 - 12/73
- 24) 08/75 - 07/79
- 25) 08/70 - 07/92
- 26) 08/79 - 12/82
- 27) 08/79 - 12/84, Ch.-24-E-023827
- 28) 01/84 - 07/92, Ch.24-E-023828 -
- 29) 10/86 - 07/92
- 30) 01/84 - 07/92, Ch.24-E-023828 -
- 31) 08/85 - 07/92
- 32) 11/84 - 07/92
- 33) 08/75 - 07/92
- 34) 07/90 - 10/04
- 35) 10/92 - 10/04
- 36) 07/90 - 10/04, 800-1200 Kg
- 37) 10/92 - 10/04, 800-1200 Kg
- 38) 04/03 - 09/04, Ch.-7 H-4-017500, 7J-4-017500
- 39) 07/04 - 09/04, Ch.-7 H-4-017500, 7J-4-017500
- 40) 04/03 - 10/04
- 41) 07/04 - 10/04

VOLVO

- 1) Piasta 363067
- 2) 57 mm zwrotnica osi
- 3) Ch.-20653
- 4) Tarcza koła, ch.20654-
- 5) Koło szprychowes, ch.20654-
- 6) Tarcza koła, koło szprychowes, -1503875
- 7) Koło szprychowes, 1503876-
- 8) Bez reduktora, ch.36634-
- 9) Z reduktorem
- 10) Bez reduktora
- 11) Tarcza koła
- 12) Koło szprychowes
- 13) Ch.-6997
- 14) Tarcza koła, ch.6998-
- 15) Koło szprychowes, ch.6998-
- 16) Spreżyny sztywne
- 17) Miękkie spreżyny
- 18) Ch.-7050
- 19) Ch.7051-

Uwagi

- 20) Ch.-23510
21) Ch.23511-
22) Ch.-2376
23) Ch.2377-
24) Ch.-6450
25) Ch.6451-
26) Ch.-703
27) Ch.704-
28) Ch.-21671
29) Ch.21672-
30) Ch.-3145 (około)
31) Ch.3146 (około)-6871
32) Ch.6872-
33) Ch.-2728
34) Ch.2729-6871
35) ABS/oprócz ABS
36) Pół sztywny most
37) Dla pojazdów stałej zabudowy
38) Dla pojazdów ruchomej zabudowy
39) Tarcza koła, żrednica sworznia 335 mm
40) ABS/oprócz ABS. Tarcza koła, żrednica sworznia 335 mm
41) Tarcza koła, ch.-27087
42) Tarcza koła, ch.27088-
43) Koło szprychowes 20" piastą, ch.-27087
44) Koło szprychowes 22" piastą, ch.-27087
45) Koło szprychowes, ch.27088-
46) Koło szprychowes 20" piastą
47) Koło szprychowes, bez reduktora
48) Tarcza koła, ch.-19745
49) Tarcza koła, ch.19746-
50) Z zawieszeniem pneumatycznymi i specjalna zabudowa
51) Z S-ride i pojedynczymi kołami
52) Tarcza koła, wcześniejsze modele
53) Koło szprychowes, wcześniejsze modele
54) Ciężarówki ze sztywną przednią osią
55) Koło szprychowes, ABS/oprócz ABS
56) Tarcza koła, ABS/oprócz ABS
57) Tarcza koła, BGT 18/21/26 Zawieszenie na resorach piórowych
58) Tarcza koła, zawieszenie pneumatyczne, S-ride , tylne sterowanie
59) Z zawieszeniem pneumatycznymi i tylnymi kołami skrętnymi
60) ABS/oprócz ABS, zawieszenie na resorach piórowych
61) Ch.-12099
62) Ch.12100-
63) Ch.12001-
64) Tarcza koła, ch.-11549
65) Tarcza koła, ch.11550-
66) Ch.-26821
67) Ch.26822-
68) Tarcza koła, ch.-40640, ABS/oprócz ABS
69) Koło szprychowes 20" hub, bez reduktora
70) Koło szprychowes 24" hub, bez reduktora
71) Tarcza koła, ch.-20876, ABS/oprócz ABS
72) Tarcza koła, ch.20877-, ABS/oprócz ABS
73) Tarcza koła, ch.25001-40640, żrednica sworznia 335 mm
74) Koło szprychowes 20" piastą, ch.25001-40640
75) Koło szprychowes 24" piastą, ch.25001-40640
76) With air suspension, ch.-25000
77) S-ride, rear steer, ch.25001-40640
78) Tarcza koła, Z reduktorem
79) Ch.-52439
80) Ch.52440-
81) Tarcza koła, ch.306000-, żrednica sworznia 335 mm
82) Koło szprychowes 20", 24" piastą, ch.306000-
83) Tarcza koła, ch.306000-, ABS/oprócz ABS, żrednica sworznia 335 mm
84) Tarcza koła, ch.-46315
85) Tarcza koła, ch.46316-, ABS/oprócz ABS
86) Koło szprychowes 24" piastą, ch.49001-
87) Tarcza koła 20", 22.5", 24" piastą
88) Ciężarówki ze sztywną przednią osią
89) Koło szprychowes 24" piastą
90) Ch.-36763
91) Ch.36764-
92) Ch.-65820
93) Ch.-65820, koło szprychowes 20", 24" piastą
94) Tarcza koła, bez reduktora
95) Tarcza koła, ch.-22914
96) Tarcza koła, ch.22915-
97) Koło szprychowes 20" piastą, ch.34001-
98) Koło szprychowes 24" piastą, ch.34001-
99) Z zawieszeniem pneumatycznymi
100) Model specjalny, super volyme S-10609, S-10610, S-10801, S-11010, S-97024, S-97025, ch.314000-
101) Koło szprychowes, 20", 24" piastą
102) Koło szprychowes, z pojedynczymi reduktorem
103) Podwójny most z reduktorem
104) Pojedyncza oś wleczona, tarcza koła
105) Podwójna oś wleczona, tarcza koła
106) Ch.-15169
107) Ch.15170-
108) Tarcza koła, ch.-8779
109) Tarcza koła, ch.8780-
110) Koło szprychowes, ch.-12000
111) Koło szprychowes 20" piastą, ch.12001-
112) Koło szprychowes 24" piastą, ch.12001-
113) Koło szprychowes 22", 22.5", 24" piastą
114) Koło szprychowes 20" piastą, z zawieszenie na resorach piórowych, ABS/oprócz ABS
115) Koło szprychowes 24" piastą, z zawieszenie na resorach piórowych
116) Koło szprychowes 20" piastą, z zawieszeniem pneumatycznymi
117) Koło szprychowes, ch.314000-, z zawieszeniem pneumatycznymi
118) Model specjalny, super volume; 1) S-10099, S-10365, S-10803, S-11011 2) S-10111, S-10112, S-97024, S-97025
119) Ch.7980
120) Ch.7981-
121) Ch.-3404
122) Ch.3405-7980
123) Ch.-5256
124) Ch.5257-
125) B 6F
126) B 6FA
127) Ch.865-. Oprócz: Ch.873-875, smarowane olejem
128) B 6F, B 609, B 610
129) B 6FA, ch.-404, piastą 6772232
130) B 6FA, ch.405-
131) Ch.20000-
132) Ch.-10521. Smarowane smarem
133) Ch.10522-. Sarowane olejem
134) Smarowane smarem, tylnymi kołami skrętnymi
135) Smarowane olejem, rear steer ABS/oprócz ABS
136) Smarowane olejem
137) Ch.-3906
138) Ch.3907-
139) Ch.4308-. ABS
140) Zawiera przednią oś, FAT 5,0
141) CHID-B169140, Tarcza koła, żrednica sworznia 335 mm
142) Oprócz ABS, Tarcza koła, żrednica sworznia 335 mm
143) Piasta 6774825. Zawiera przednią oś, FAT 4,7
144) CHID -B170985
145) CHID B170986-
146) S-60677, S-60936
147) Tarcza koła, żrednica sworznia 335 mm, z zawieszeniem pneumatycznymi
148) Tarcza koła, żrednica sworznia 335 mm, BAT 11,5 zawieszenie na resorach piórowych
149) 6X2 TAG (HENDRICKSON)
150) 6774825, 6795568
151) Incl. special model: S-60945, S-60990, S-60993, S-61208, S-61230
152) B 6FA, ch.-404. (Repl. 6772232, 6770991, 6771541, 960234, 6772691,95678, 18665. One pcs of each)
153) ABS/oprócz ABS. Ch.5000-
154) Ch.5000-
155) CHID.-A276505, -B190367, -563621
156) BAT 10,0 BAT 10,9 BAT 11,2
157) BAT 11,5 BLF-B BAT 13,0
158) BAT 11,5 LUF-B
159) Zawiera przednią oś, FAT 4,7
160) WTT-D275
161) Ch.-A286102, -B207062, D120498



Hur man hittar i katalogen

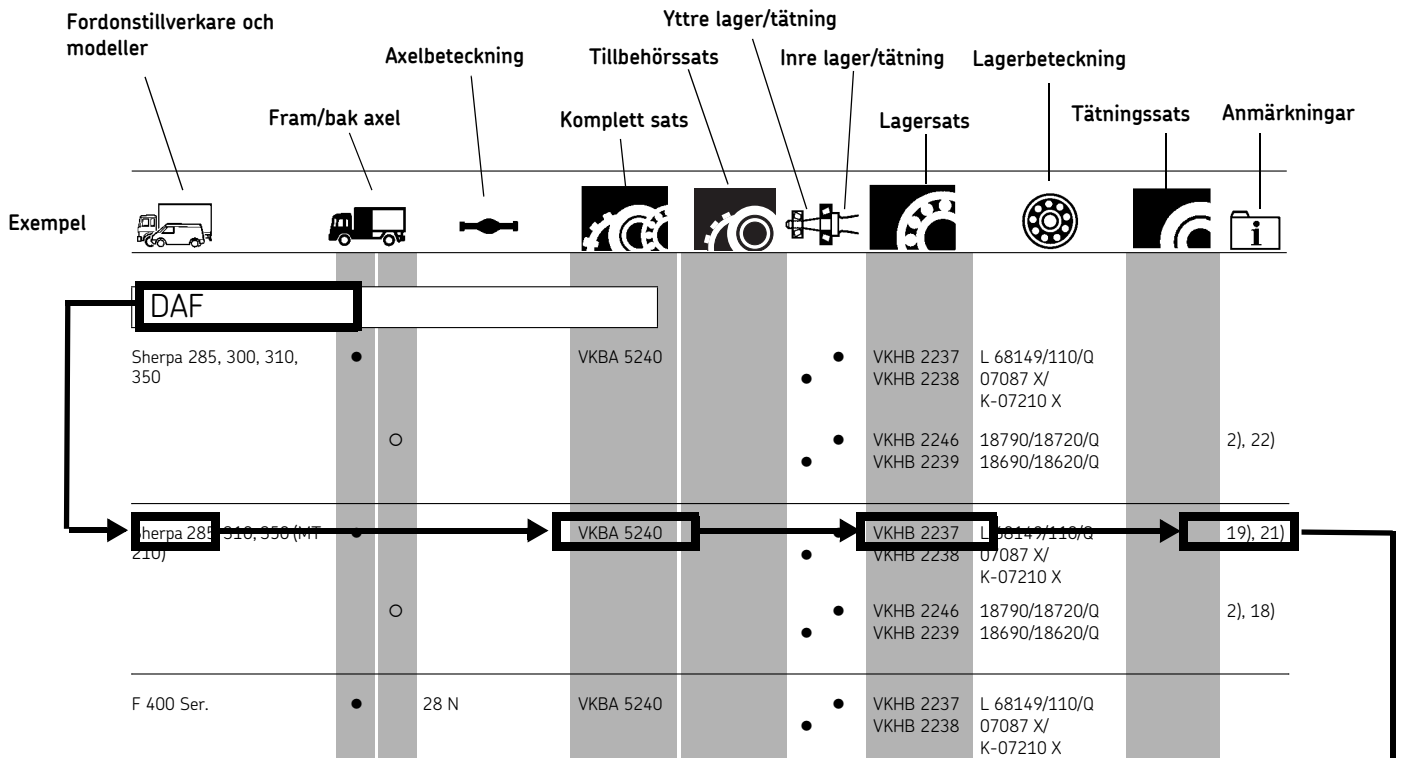

Innehållet i satserna

	A	B	C	D	E	F	G	H	I	J	K	L		
VKA 4004							1		1				VOLVO	● ○
VKA 4026							1		1				VOLVO	○ ○
VKA 4036							2	1					SCANIA	○ ○
VKA 4038							1	1					SCANIA	○ ○
VKA 4094							2	1					MERCEDES-BENZ	● ○
VKA 4095							1	2					MERCEDES-BENZ	● ○

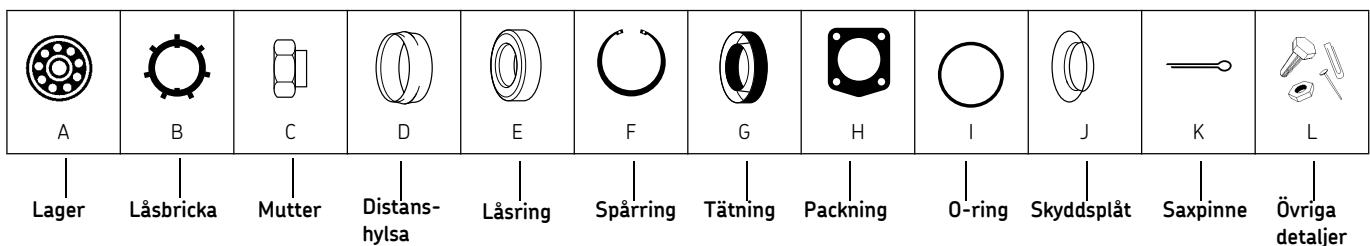

VKBA =VKHB + VKHB + VKA/VKS

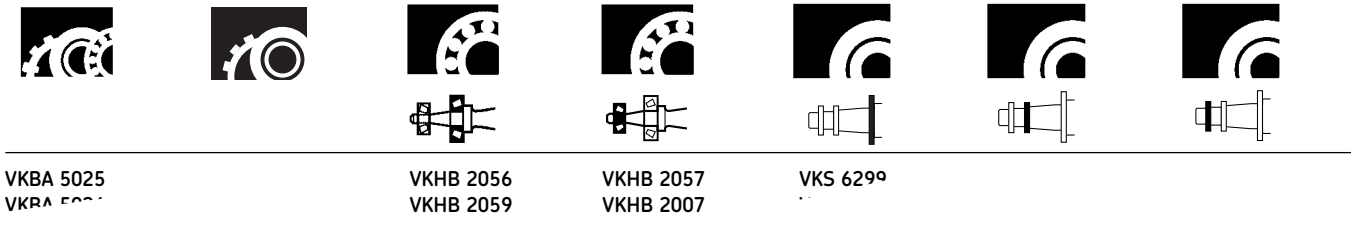

Översättningslista OE - SKF

BPW		FIAT / IVECO
02.5664.26.57 02.5664.46.57 02.5664.55.57	VKS 6285 VKS 6287 VKS 6250 VKS 6251	0174592 0174595 0190069 0221664 0266487
		VKHB 2043 VKHB 2141 VKS 6171 VKHB 2222 VKHB 2223
		1101597 1102042
		VKHB 2060 VKHB 2282 VKHB 2283

Översättningslista SKF - OE

VKBA 519	VKBA 3616
VW VW	RENAULT / RVI OPEL OPEL
VKBA 523 VKBA 528	
FORD FORD MERCEDES BENZ	
211 498 071 211 498 071 BS 5 007 029 5 007 028 116 220 00 51	77 01 206 742 44 08 669 91160087 77 01 206 848 11 00 00 00

Lager - SKF VKHB

07087 X/K-07210 X 100 200 00 00	VKHB 2238 VKHB 2268	VKHB 2303
	32310 TN9 32311 12	30500/39520/Q
		VKHB 2175

Sökning på dimension (tätning)

d	D	W		d	D	W	
44,0 53,0	85,0 97,0	10,0/8,0 8,0 12,0	VKS 6229 VKS 6219 VKS 6224	120,0 120,0	140,0 -	15,5/13,5 14,2	VKS 6303 VKS 6225

SVENSKA



Symboler

Kapitelsymboler

	Nya satser		VKBA=VKHB+VKHB+VKA/VKS
	Fordonsapplikation, lastbilar		Översättningslista OE - SKF
	Fordonsapplikation, bussar		Översättningslista SKF - OE
	Fordonsapplikation, trailer		Lager - SKF VKHB
	Innehåll i satserna		Sökning på dimension (tätning)

Universella symboler

	Upp till
	Från
	Ersättningar
	Annullerade satser
	Verktyg

Förkortningar

Ch.	Chassi nummer
Forward rear axle	Främre bakaxeln
Rear rear axle	Bakre bakaxlen
Trailing axle	Löphjuls axel

VKBA XXXX	I produktion
VKHB XXXX	I produktion
VKA XXXX	I produktion
VKS XXXX	I produktion
VKN XXX	I produktion

Anmärkningar

BPW

- 1) Låglastare
- 2) Ej låglastare

CITROËN

- 1) 09/81 - 12/89, Ch.-604496
- 2) 01/89 - 03/04, Ch.604497 -
- 3) 02/91 - 03/94
- 4) 01/87 - 12/89, Ch.-604496
- 5) 01/89 - 02/94, Ch. 604497 -
- 6) 09/81 - 12/86, vänster hjul, Ch.-289710, lastkapacitet : 1000, 1300 Kg
- 7) 09/81 - 12/86, höger hjul, Ch.-289710, lastkapacitet : 1000, 1300 Kg
- 8) 09/81 - 03/94, vänster hjul, lastkapacitet :1800 Kg
- 9) 09/81 - 03/94, höger hjul, lastkapacitet : 1800 Kg
- 10) 01/86 - 03/94, vänster hjul, Ch.289711-, lastkapacitet : 1000, 1300, 1400 Kg
- 11) 01/86 - 03/94, höger hjul, Ch.289711-, lastkapacitet : 1000, 1300, 1400 Kg
- 12) 01/87 - 02/94,
- 13) 02/94 - 04/02, Ch.-16194399, lastkapacitet :1000, 1400 Kg
- 14) 02/94 - 04/02, Ch.-16194399, lastkapacitet : 1800 Kg
- 15) 02/94 - 04/02, Ch.16194400 -, lastkapacitet : 1000, 1400 Kg
- 16) 02/94 - 04/02, Ch.16194400 -, lastkapacitet : 1800 Kg
- 17) 04/02 - 09/04, lastkapacitet : 1000, 1400 Kg
- 18) 04/02 - 09/04, lastkapacitet : 1800 Kg
- 19) 03/94 - 04/02, Ch.-16194399, lastkapacitet : 1000, 1400 Kg
- 20) 03/94 - 04/02, Ch.-16194399, lastkapacitet : 1800 Kg
- 21) 03/94 - 04/02, Ch.16194400 -, lastkapacitet : 1000, 1400 Kg
- 22) 03/94 - 04/02, Ch.16194400 -, lastkapacitet : 1800 Kg
- 23) 08/96 - 04/02, Ch.-16194399, lastkapacitet : 1000, 1400 Kg
- 24) 08/96 - 04/02, Ch.-16194399, lastkapacitet : 1800 Kg
- 25) 08/96 - 04/02, Ch.16194400 -, lastkapacitet : 1000, 1400 Kg
- 26) 08/96 - 04/02, Ch.16194400 -, lastkapacitet : 1800 Kg
- 27) 02/94 - 04/02, Ch.16194400 -
- 28) Trumbromsar
- 29) Skivbromsar

DAF

- 2) Dubbla bakhjul
- 3) Spårvidd 1718 mm, with 10 bolts nav
- 4) Spårvidd 1655 mm, with 8 bolts nav
- 5) Ej navcentrering
- 6) Med navcentrering
- 7) Med navcentrering. Svart tätning
- 8) Med navcentrering. Blå tätning
- 9) Med navreduktion
- 10) Ej FAR

- 11) Med FAR
- 12) Ej FA, FT
- 13) Med FA, FT
- 14) Ej navcentrering. Svart tätning
- 15) Ej navcentrering. Blå tätning
- 16) Svart tätning
- 17) Blå tätning
- 18) 1983-85
- 19) Ch.237886-, enkelt bakhjul
- 21) 1984-85
- 22) 1985-12/89
- 23) -12/89
- 24) Oljetätning/ABS-ring ej intergrerade

FIAT-IVECO

- 4) Vänster hjul
- 5) Höger hjul
- 8) Vänster hjul, 06/79-06/81
- 9) Höger hjul, 06/79-06/81
- 10) 10/77-06/81
- 11) Vänster hjul, 06/81-09/84
- 12) Höger hjul, 06/81-09/84
- 13) 06/81-09/84
- 14) Vänster hjul, 10/84-88
- 15) Höger hjul, 10/84-88
- 16) 10/84-88
- 17) 03/85-88
- 18) Ch.-604496, 1982-89
- 19) Ch.604497-, 1989-93
- 20) Vänster hjul, ch.-278757, 1982-86
- 21) Höger hjul, ch.-278757, 1982-86
- 22) Vänster hjul, ch.278758-, 1986-93
- 23) Höger hjul, ch.278758-, 1986-93
- 24) 1982-86
- 25) Ch.-604496, 1986-89
- 26) Vänster hjul, 1986-93
- 27) Höger hjul, 1986-93
- 28) 10/77-12/86
- 29) 01/87-
- 30) Ej 50-9 D, 50-9 V
- 31) 04/91-04/92
- 32) 01/85-
- 33) Skivbromsar
- 34) 12/85-
- 36) 1991-94
- 37) Vänster hjul, 1991-94
- 38) Höger hjul, 1991-94
- 39) Ej ABS
- 40) Ej modeller för Schweiz
- 41) Modeller för Schweiz
- 42) Utväxling 4.23/1
- 43) Ej utväxling 4.23/1
- 44) Utväxling 4.23/1. Ej modeller för Schweiz
- 45) Ej utväxling 4.23/1. Ej modeller för Schweiz
- 46) Ej utväxling 3.79/1
- 47) Utväxling 3.79/1
- 48) CH. -173788
- 49) Ch.173789-. Axel -1824487
- 50) Ch.173789-. Axel 1824488-
- 51) Ch.173789-
- 52) Inre lagrets håldiameter 95 mm
- 53) Inre lagrets håldiameter 105 mm. Axel -1824487
- 54) Inre lagrets håldiameter 105 mm. Axel 1824488-

- 55) Styrande axel. Ej-styrande axel, spare part No 7177196
- 56) Ej-styrande axel, Spare part No 7177168
- 57) Inre lagrets håldiameter 100 mm
- 58) Axel -1824487
- 59) Axel 1824488-
- 60) Vänster hjul, 06/79-01/97
- 61) Höger hjul, 06/79-01/97
- 62) 06/81-01/97
- 63) Vänster hjul, 06/81-88
- 64) Höger hjul, 06/81-88
- 65) Ej utväxling 5.22/1. -02/96
- 66) Utväxling 5.22/1. -02/96
- 67) Vänster hjul, 06/79-02/96
- 68) Höger hjul, 06/79-02/96
- 69) 10/77-09/84
- 70) Ej "Iveco check control"
- 71) "Iveco check control"
- 72) Vänster hjul, -02/96
- 73) Höger hjul, -02/96
- 74) -2/96
- 75) Utväxling 5.62/1
- 76) Ej utväxling 5.62/1
- 77) ABS
- 78) Vänster hjul, 03/85-88
- 79) Höger hjul, 03/85-88
- 81) 02/96
- 82) 03/96-
- 83) 1994-
- 84) 1996-
- 85) Endadigt koniskt rullagers
- 86) Dubbelradigt koniskt rullager
- 87) Ej-styrande axel
- 88) Styrande axel
- 89) Framhjulsdrift
- 90) Ej framhjulsdrift
- 91) Vänster framhjul, endadigt koniskt rullager, 03/96 - 12/99
- 92) Höger framhjul, endadigt koniskt rullager, 03/96 - 12/99
- 93) Dubbelradigt koniskt rullager , 03/96 - 12/99
- 94) Till 05/89
- 95) 06/89 - 01/97
- 96) 01/96 - 12/99
- 97) Till 12/99
- 98) 05/99 - 08/03
- 99) 06/81 - 01/97
- 100) 04/02 - 01/04
- 101) 07/02 - 01/04
- 102) Lastkapacitet 1100, 1500 Kg
- 103) Lastkapacitet 1800 Kg

FORD

- 1) 1965-91
- 2) 07/74-12/77
- 3) 08/65-12/77
- 6) 11/73-12/77
- 7) 01/78-10/85
- 8) Vänster hjul, 11/85-91
- 9) Höger hjul, 11/85-91
- 10) 11/85-91
- 11) 1992-97
- 12) 01/81-03/87
- 13) 03/87-12/92
- 14) 04/82 - 09/87
- 15) 10/87 - 12/90, vänster hjul

Anmärkningar

- 10/87 - 12/90, höger hjul
- 01/00 - 10/04
- 01/00 - 10/04, ej ABS, lastkapacitet 1000 Kg, FWD
- 01/00 - 10/04, ABS, lastkapacitet 1000 Kg, FWD
- 07/03 - 10/04, ej ABS, lastkapacitet 2000 Kg, FWD
- 07/03 - 10/04, ABS, lastkapacitet 2000 Kg, FWD
- 01/00 - 10/04, enkelhjul, bakhjulsdrift
- 01/00 - 10/04, dubbelhjul, bakhjulsdrift
- 03/04 - 10/04, ej ABS, lastkapacitet 2000 Kg
- 03/04 - 10/04, ABS, lastkapacitet 2000 Kg

GIGANT (SAE)

- 1) Luftfjädring Typ N
- 2) Protec axel

FRUEHAUF

- 1) 107, 6 mm axel, med C1/C2 bromsar
- 2) 110 mm axel, med D1/K1/H1 bromsar
- 3) 110 mm axel, med C1/C2/L1/L2 (100 tänders) bromsar
- 4) 110 mm axel, med C3/C5 (80 tänders) bromsar

MAN

- 1) -11/93
- 2) 12/93-
- 3) W25/86-W27/90
- 4) W28/90-
- 5) Ej ABS
- 6) ABS
- 7) 01/90-
- 8) Nav. 81.35701.0081
- 9) Nav. 81.35701.0127
- 10) 20" TRILEX
- 11) Nav. 81.35701.0141
- 12) Ej "TRILEX"
- 13) "TRILEX"
- 14) -W18/94
- 15) W19/94-
- 16) -W27/96
- 17) W28/96-, 19.5" nav
- 18) W28/96-, 20/22.5" nav

MERCEDES-BENZ

- 1) 02/88 - 02/96
- 2) 02/88 - 02/96, Ch.-128165
- 3) 1983-94
- 4) Ch.-48630
- 5) Ch.48631-
- 6) Dieselmotor ch.-17768, bensinmotor ch.-1288
- 7) Dieselmotor ch.17768-78114, bensinmotor ch.1289-4706
- 8) Dieselmotor ch.78115-, bensinmotor ch.4707-

- 9) Inre lagrets håldiameter 55
- 10) Axel -1358880
- 11) Axel 1358881-
- 12) 02/88 - 02/96, Ch.128166-
- 13) Axel -1278813
- 14) Axel 1278814-
- 15) 02/88 - 05/92, pickup
- 16) 02/73 - 12/77
- 17) 01/95 - 05/02, till axel: S213915/Y245976
- 18) 01/95 - 05/02
- 19) Axel -1390839
- 20) Axel 1390840-
- 21) Axel -1278313
- 22) Axel 1278314-
- 23) 02/95 - 07/04, till axel: S231915/Y245976
- 24) Trumbromsar
- 25) ABS, axel -021298
- 26) ABS, axel 021299-
- 27) Axel -724723
- 28) Axel 724724-
- 29) Nav: 355 356 44 01
- 30) Nav: 346 356 30 01
- 31) 02/95 - 07/04
- 32) 02/96 - 05/02, till axel: S231915/Y245976
- 33) 02/96 - 05/02,
- 34) 09/96 - 07/04
- 35) 02/96 - 07/04
- 37) Nav: 668 356 01 01, 668 356 02 01
- 38) Nav: 972 356 01 01
- 39) Nav: 976 356 11 01
- 40) Nav: 678 356 04 01
- 41) Nav: 675 356 01 01
- 42) Skivbromsar
- 43) Nav: 942 334 08 01
- 44) Nav: 942 334 07 01, 949 334 05 01

MERITOR (ROR)

- 1) Fettsmort

MONTENEGRO

- 1) Axel 061001243, 061001243A
- 2) Axel 06-1-1068
- 3) Axel 06-1-1176, 061001231
- 4) Axel 061001271
- 5) Axel 061001231A
- 6) Axel 061001230, 061001230A
- 7) Axel 06-1-1025
- 8) Axel 061001170A
- 9) Axel 061001299
- 10) Axel 061001210, 061001210B, 061001295
- 11) Axel 06-1-1103, 06-1-1170
- 12) Axel 06-1-1100, 06-1-1102, 06-1-1106, 06-1-1108, 06-1-1173, 06-1-1174

OPEL

- 1) 09/00 - 10/01, 15" hjul, Ch.-B 000010, motorkod: F9Q-770
- 2) 09/00 - 10/01, 15" hjul, Ch. B 000011-, motorkod: F9Q-770
- 3) 07/98 - 10/01, 16" hjul

- 4) 07/98 - 10/01, pickup, 15" hjul, Ch.-B 0000514, B 006055, motorkod: S8U-702
- 5) 07/98 - 10/01, transportvagn, buss, Dumpertruck, 15" hjul, Ch.-B 051615, motorkod: S9W-702
- 6) 07/98 - 10/01, pickup, 15" hjul, Ch.B 0000515-, B 006056-, motorkod: S8U-702
- 7) 07/98 - 10/01, transportvagn, buss, tipplastbil, 15" hjul, Ch.B 051616-, motorkod: S9W-702
- 8) 07/98 - 10/01, 15" hjul
- 9) 07/98 - 10/01, 16" hjul
- 10) 08/01 - 08/05, Ej ABS, Ch.- 3V613233
- 11) 08/01 - 08/05, ABS, Ch.- 3V613233
- 13) 08/01 - 08/05

PEUGEOT

- 1) 01/83 - 11/88
- 2) 10/90 - 01/01
- 3) 09/81 - 12/89, Ch.-604496
- 4) 01/89 - 09/90, Ch.604497-
- 5) 09/81 - 12/85, vänster hjul, lastkapacitet 1000 Kg, 1300 Kg, Ch.-244300
- 6) 09/81 - 01/01, vänster hjul, lastkapacitet 1400 Kg
- 7) 09/81 - 01/01, vänster hjul, lastkapacitet 1800 Kg
- 8) 09/81 - 01/01, höger hjul, lastkapacitet 1400 Kg
- 9) 09/81 - 01/01, höger hjul, lastkapacitet 1800 Kg
- 10) 01/86 - 11/88, vänster hjul, lastkapacitet 1000 Kg, 1300 Kg, Ch. 244301-
- 11) 09/81 - 12/85, höger hjul, lastkapacitet 1000 Kg, 1300 Kg, Ch.-244300
- 12) 01/86 - 11/88, höger hjul, lastkapacitet 1000 Kg, 1300 Kg, Ch.244301-
- 13) 10/90 - 01/01, vänster hjul, lastkapacitet 1000 Kg, 1300 Kg
- 14) 10/90 - 01/01, höger hjul, lastkapacitet 1000 Kg, 1300 Kg
- 15) 1967-09/70
- 16) 10/70-80
- 17) 1967-80
- 18) 1980-88
- 19) 03/94 - 04/02, lastkapacitet 1000 Kg, 1400 Kg, Ch.-16194399
- 20) 03/94 - 04/02, lastkapacitet 1800 Kg, Ch.-16194399
- 21) 03/94 - 04/02, lastkapacitet 1000 Kg, 1400 Kg, Ch.16194400-
- 22) 03/94 - 04/02, lastkapacitet 1800 Kg, Ch.16194400-
- 23) 04/02 - 07/04, lastkapacitet 1000 Kg, 1400 Kg
- 24) 04/02 - 07/04, lastkapacitet 1800 Kg
- 25) 07/96 - 04/02, lastkapacitet 1000 Kg, 1400 Kg, Ch.-16194399
- 26) 07/96 - 04/02, lastkapacitet 1800 Kg, Ch.-16194399
- 27) 07/96 - 04/02, lastkapacitet 1000 Kg, 1400 Kg, Ch.16194400-
- 28) 07/96 - 04/02, lastkapacitet 1800 Kg, Ch.16194400-
- 29) 03/04 - 04/02, Ch.16194400-
- 30) 04/02 - 07/04

Anmärkningar

- 31) 10/01 - 04/02
- 32) 11/00 - 09/01, lastkapacitet 1000 Kg, 1400 Kg
- 33) 11/00 - 09/01, lastkapacitet 1800 Kg
- 34) 07/96 - 04/02, trumbromsar
- 35) 07/96 - 04/02, skivbromsar
- 36) 01/86 - 01/01, vänster hjul, lastkapacitet 1000 Kg, 1300 Kg, Ch.244301-
- 37) 01/86 - 01/01, höger hjul, lastkapacitet 1000 Kg, 1300 Kg, Ch.244301-

RVI

- 12) -14/06/85
- 13) 17/06/85-
- 14) -12/82
- 15) 01/83-
- 16) -15/11/85
- 17) 18/11/85-
- 18) -1986
- 19) 1987-
- 22) 07/86-
- 23) -14/03/84
- 24) 15/03/84-
- 25) 10/84-01/86
- 26) 02/86-
- 27) -09/84
- 28) -01/86
- 29) 10/84-
- 30) -09/83
- 31) 10/83-
- 33) -08/79
- 34) 09/79-
- 35) -08/84 MOT 62030
- 36) -12/83
- 37) 01/84-
- 38) -12/85
- 39) 01/86-
- 40) 12/92-
- 41) -05/91
- 42) 06/91-03/93
- 43) 04/93-
- 44) -08/84 MOT 62030. -N
- 45) -08/84 MOT 62030. N 1540
- 47) 09/93-
- 48) Ej ABS. -08/91
- 49) ABS. -08/91
- 50) 09/91-03/93
- 51) 09/91-
- 52) -03/93
- 53) -08/91
- 54) -07/90
- 55) 08/90-
- 56) -02/91
- 57) 03/91-
- 58) -09/90
- 59) -02/92
- 60) 03/92-
- 61) -05/95
- 62) 06/95-
- 63) Trumbromsar
- 64) Skivbromsar
- 65) -2/85
- 66) 03/85-
- 67) -17/11/93
- 68) 18/11/93-
- 69) 10/87-

- 70) ABS
- 71) -12/92
- 72) 01/93 - 17/08-98
- 73) 01/77-14/03/84
- 74) 03/86-
- 75) Ej ABS. -08/91. Ej "Trilex".
- 76) ABS. -08/91. Ej "Trilex".
- 77) "Trilex"-20". -03/93.
- 78) "Trilex"-24". -03/93.
- 79) 09/91-03/93. Ej "Trilex".
- 80) -2/86
- 81) -12/87
- 82) Låsmutter M75. -05/91
- 83) Låsmutter M70. -05/91
- 84) Ej ABS
- 85) ABS
- 86) -05/95
- 87) 06/95-
- 88) -03/89
- 89) 04/89-
- 90) 1973-1989
- 91) Ej motor G9T
- 92) Motor G9T
- 96) 03/89 - 04/89, transportvagn, buss, inre lagret 35x72x24.5 mm
- 97) 03/89 - 04/89, transportvagn, buss, inre lagret 35x62x18.3 mm
- 98) 05/89 - 10/97, pickup
- 100) 03/80 - 04/89, transportvagn, buss
- 101) 03/80 - 04/89, pickup
- 102) 18/08/98 -
- 103) - 31/03/98
- 104) 01/04/98 -
- 105) - 27/08/98
- 106) - 24/08/98
- 107) - 17/08/98
- 108) Enkelhjul
- 109) Dubbel hjul
- 110) 01/09/91 - 31/03/93
- 111) - 11/04/2000
- 112) 12/04/2000 -
- 113) 03/80 - 04/89
- 114) 03/80 - 12/83, transportvagn, buss
- 115) 03/80 - 02/89
- 116) 01/84 - 12/85, transportvagn, buss
- 117) 01/86 - 02/89, transportvagn, buss
- 118) 03/89 - 04/89
- 119) 05/89 - 01/01, transportvagn, buss
- 120) 05/89 - 01/01
- 121) 05/89 - 01/01, pickup, Model type:PC
- 122) 05/89 - 01/01, transportvagn, buss, inre lagret 35x72x24.5 mm
- 123) 05/89 - 01/01, transportvagn, buss, inre lagret 35x62x18.3 mm
- 124) 03/01 - 11/02, Ej ABS
- 125) 03/01 - 11/02, ABS
- 126) 11/02 - 02/04
- 127) 03/01 - 02/04
- 128) 08/80 - 07/98, transportvagn, buss
- 129) 09/80 - 07/98, pickup
- 130) 07/98 - 03/00
- 131) 03/00 - 02/02
- 132) 07/98 - 01/01
- 133) 07/98 - 10/01, transportvagn, buss
- 134) 07/98 - 10/01, transportvagn, pickup
- 135) 09/00 - 02/04, transportvagn, trumbromsar
- 136) 09/00 - 02/04, transportvagn, skivbromsar
- 137) 09/00 - 02/04, buss, trumbromsar
- 138) 09/00 - 02/04, buss, skivbromsar

- 139) 09/00 - 02/04, pickup, trumbromsar
- 140) 09/00 - 02/04, pickup, skivbromsar
- 141) 07/98 - 01/01, transportvagn, trumbromsar
- 142) 07/98 - 01/01, transportvagn, skivbromsar
- 143) 10/01 - 02/04, transportvagn, trumbromsar
- 144) 10/01 - 02/04, transportvagn, skivbromsar
- 145) 07/98 - 01/01, buss, trumbromsar
- 146) 07/98 - 01/01, buss, skivbromsar
- 147) 10/01 - 02/04, buss, trumbromsar
- 148) 10/01 - 02/04, buss, skivbromsar
- 149) 07/98 - 01/01, pickup, trumbromsar
- 150) 07/98 - 01/01, pickup, skivbromsar
- 151) 10/01 - 02/04, pickup, trumbromsar
- 152) 10/01 - 02/04, pickup, skivbromsar
- 153) 07/98 - 10/01, transportvagn, trumbromsar
- 154) 07/98 - 10/01, transportvagn, skivbromsar
- 155) 07/98 - 10/01, pickup, trumbromsar
- 156) 07/98 - 10/01, pickup, skivbromsar
- 157) 10/03 - 02/04, transportvagn, trumbromsar
- 158) 10/03 - 02/04, transportvagn, skivbromsar
- 159) 10/03 - 02/04, buss, trumbromsar
- 160) 10/03 - 02/04, buss, skivbromsar
- 161) 10/03 - 02/04, pickup, trumbromsar
- 162) 10/03 - 02/04, pickup, skivbromsar

SCANIA

- 1) Ch.-1032241
- 2) Ch.1032242-
- 3) Skivhjul, ch.-1032241
- 4) Skivhjul, ch.1032242-
- 5) Ekerhjul
- 6) Skivhjul, ch.-1097602 SSS, ch.-4246024 SN
- 7) Skivhjul, ch.1097603 SSS-, ch.4246025 SN-
- 8) Ekerhjul, ch.-1105665 SSS, ch.-4238514 SN
- 9) Ekerhjul, ch.1105666 SSS-, ch.4238515 SN-
- 10) Skivhjul
- 11) Ekerhjul, chassis width 2300 mm
- 12) Ekerhjul 20" or 22.5" nav, ch.-1103187 SSS, ch.-4248317 SN
- 13) Ekerhjul 20" or 22.5" nav, ch.1103188 SSS-, ch.4248318 SN
- 14) Ekerhjul, 24" nav
- 15) Ch.-1097602 SSS, ch.-4246024 SN
- 16) Ch.1097603 SSS-, ch.4246025 SN-
- 17) Skivhjul, ch.-1033747
- 18) Skivhjul, ch.1033748-
- 19) Ekerhjul 20" or 22" nav, ch.-1103187 SSS, ch.-4248317 SN
- 20) Ekerhjul, 20" or 22" nav, ch.1033188 SSS-, ch.4248318 SN-
- 21) Skivhjul, Ekerhjul
- 22) Skivhjul, (4x2, 6x2, 6x4)
- 23) Ekerhjul, (4x2, 6x2, 6x4) 20" or 22.5" nav
- 24) Ekerhjul, 24" nav. Bromsback 178 mm
- 25) Ekerhjul, 24" nav. Bromsback 203 mm
- 26) Dubbel styrande axel
- 27) Ekerhjul, 20", 22.5" or 24" nav
- 28) Ej navreduktion
- 29) Med navreduktion
- 30) Skivhjul, ch.-1029858
- 31) Skivhjul, ch.1029859-
- 32) Skivhjul, Ekerhjul, 24" nav
- 33) Skivhjul, Ekerhjul, 20" or 22.5" nav
- 34) Skivhjul, Ekerhjul, 20", 22.5" or 24" nav



Anmärkningar

- 35) Skivhjul, ch.-1161721 SSS, ch.-4292924 SN
- 36) Skivhjul, ch.1161722 SSS-, ch.4292925 SN-
- 37) Skivhjul, Ekerhjul, 24" nav, ch.-1180029 SSS
- 38) Skivhjul, Ekerhjul, 24" nav, ch.1180030 SSS-
- 39) Skivhjul, ch.-1850412
- 40) Skivhjul, ch.1850413-
- 41) Bladfjädring, ch.-1801229
- 42) Bladfjädring, ch.1801230-
- 43) Luftfjädring, ch.-1802872
- 44) Luftfjädring, ch.1802873-
- 45) Ch.-1801229
- 46) Ch.1801230-
- 47) Skivhjul, ABS/Ej ABS
- 48) ABS/Ej ABS
- 49) Luftfjädring
- 50) Luftfjädring, ABS
- 51) Luftfjädring, trapeze fjädring
- 52) Luftfjädring, trapeze fjädring, ABS
- 53) Skivhjul, ch.-1871409
- 54) Ch.1871410-1871595
- 55) Ch.1871596-
- 56) Ch.1871410-
- 57) Bromsback 5"
- 58) Bromsback 7". Ch.1801196-
- 59) Ch.-1801195
- 60) Ch.1801196-
- 61) Ch.-1808231
- 62) Ch.1808232-
- 63) ABS/Ej ABS, Ch.-1808901, Ch.1808902
- 64) ABS/Ej ABS, Ch.-1806768, Ch.1806769-
- 65) Nav för löpaxel
- 66) Skivhjul, ABS/Ej ABS, Ch.-1808901, Ch.1808902-
- 67) Luftfjädring, 22.5" nav
- 68) Luftfjädring, 22.5" nav, ABS
- 69) ABS
- 70) Nav 8.25 x 22.5"
- 71) Nav 8.25 x 22.5". ABS
- 72) Nav 9.00 x 22.5"
- 73) Nav 9.00 x 22.5". ABS
- 74) 6.5 tons
- 75) 6.5 tons, ABS
- 76) 7.1 tons
- 77) 7.1 tons, ABS
- 78) 6.5 tons, Ch.-1820117, Ch.1820118-
- 79) 6.5 tons, Ch.-1820117, ABS
- 80) 7.1 tons, Ch.-1820117
- 81) 7.1 tons, Ch.-1820117, ABS
- 82) ABS/Ej ABS, Ch.-1820117, Ch.1820118-
- 83) Luftfjädring, ch.-1801229
- 84) Luftfjädring, ch.1801230-1802872
- 85) Skivhjul, Ej ABS, Ch.9015825 SAN-, Ch.4362206 SNL-, Ch.1226892 SSS-
- 86) Skivhjul, ABS, Ch.9015825 SAN-, Ch.4362207 SNL-, Ch.1226892 SSS-
- 87) Ekerhjul, ABS/Ej ABS
- 88) Skivhjul, ABS/Ej ABS, Ch.9015825 SAN-, Ch.4362207 SNL-, Ch.1226892 SSS-
- 89) Skivhjul, Ej ABS, Ch.9015825 SAN-, Ch.4362207 SNL-, Ch.1226207 SSS-
- 90) Skivhjul, Ej ABS
- 91) Skivhjul, Ej ABS, RP/RBP 730
- 92) Ej ABS, RP/RBP 832
- 93) Skivhjul, ABS
- 94) Skivhjul/Ekerhjul, ABS/Ej ABS, Ch.9015825 SAN-, Ch.4362207 SNL-, Ch.1226892 SSS-
- 95) Ekerhjul, Ej ABS
- 96) Skivhjul, Ch.1820118-, ABS
- 97) Skivhjul, Ch.1820118-, Ej ABS

- 98) To Ch.nr: Scania Sodertalje 1242205, Scania Zwolle 4397541, Scania Angers 9034654, Scania Katrineholm 1833391
- 99) Skivhjul, skivbromsar, ABS
- 100) Ekerhjul, 22", 22,5" nav
- 101) RP/RBP 832
- 102) 22", 22,5", 24" nav
- 103) 20", 22,5" nav, RBP/RP730
- 104) 24" nav, RP/RBP 832
- 105) Skivhjul Ch.-9015824 SAN, Ch.-4365570 SNL, Ch.-1226891 SSS
- 106) Skivhjul, ABS, Ch.-9015824 SAN, Ch.-4362206 SNL, Ch.-1226891 SSS
- 107) Skivhjul, skivbromsar, ABS/Ej ABS

SMB

- 1) 107, 6 mm axel, med C1/C2 bromsar
- 2) 110 mm axel, med D1/K1/H1 bromsar
- 3) 110 mm axel, med C1/C2/L1/L2 (100 tänders) bromsar
- 4) 110 mm axel, med C3/C5 (80 tänders) bromsar

TRAILOR

- 1) 107, 6 mm axel, med C1/C2 bromsar
- 2) 110 mm axel, med D1/K1/H1 bromsar
- 3) 110 mm axel, med C1/C2/L1/L2 (100 tänders) bromsar
- 4) 110 mm axel, med C3/C5 (80 tänders) bromsar

VOLKSWAGEN

- 1) 1976-96
- 5) Ch.21N-006786 -, 08/91-96, 22,5 mm låsring
- 7) Ej dubbel hjul, Ch.28G-015892 - 21N-006785, 04/86-07/91, 20 mm låsring
- 8) Ej dubbel hjul, Ch.21N-006786 -, 08/91-96, 22,5 mm låsring
- 9) Spiralfjädring, 1979-82
- 10) Bladfjädring, ch.-28-B-018540, 1979-81
- 11) Bladfjädring, ch.28-B-018541-, 1981-82
- 12) 1979-82
- 13) Ch.-28-B-019162, 1979-81
- 14) Ch.28-B-019163-, 1981-82
- 15) 1983-96
- 16) 3500 kg, 1983-96
- 17) 4000 kg, 1983-96
- 18) 1984-96
- 19) 05/96 - 10/04
- 20) 05/96 - 10/04, Mod. LT 28, LT 35
- 21) 05/96 - 10/04, Mod. LT 46
- 22) 08/67 - 07/79
- 23) 08/71 - 12/73
- 24) 08/75 - 07/79
- 25) 08/70 - 07/92
- 26) 08/79 - 12/82
- 27) 08/79 - 12/84, Ch.-24-E-023827
- 28) 01/84 - 07/92, Ch.24-E-023828 -
- 29) 10/86 - 07/92
- 30) 01/84 - 07/92, Ch.24-E-023828 -

- 31) 08/85 - 07/92
- 32) 11/84 - 07/92
- 33) 08/75 - 07/92
- 34) 07/90 - 10/04
- 35) 10/92 - 10/04
- 36) 07/90 - 10/04, 800-1200 Kg
- 37) 10/92 - 10/04, 800-1200 Kg
- 38) 04/03 - 09/04, Ch.-7 H-4-017500, 7J-4-017500
- 39) 07/04 - 09/04, Ch.-7 H-4-017500, 7J-4-017500
- 40) 04/03 - 10/04
- 41) 07/04 - 10/04

VOLVO

- 1) Nav 363067
- 2) 57 mm axeltapp
- 3) Ch.-20653
- 4) Skivhjul, ch.20654-
- 5) Ekerhjul, ch.20654-
- 6) Skivhjul, ekerhjul, -1503875
- 7) Ekerhjul, 1503876-
- 8) Ej navreduktion, ch.36634-
- 9) Med navreduktion
- 10) Ej navreduktion, ch.36634-
- 11) Skivhjul
- 12) Ekerhjul
- 13) Ch.-6997
- 14) Skivhjul, ch.6998-
- 15) Ekerhjul, ch.6998-
- 16) Hård fjädring
- 17) Mjuk fjädring
- 18) Ch.-7050
- 19) Ch.7051-
- 20) Ch.-23510
- 21) Ch.23511-
- 22) Ch.-2376
- 23) Ch.2377-
- 24) Ch.-6450
- 25) Ch.6451-
- 26) Ch.-703
- 27) Ch.704-
- 28) Ch.-21671
- 29) Ch.21672-
- 30) Ch.-3145 (approx.)
- 31) Ch.3146 (approx.)-6871
- 32) Ch.6872-
- 33) Ch.-2728
- 34) Ch.2729-6871
- 35) ABS/Ej ABS
- 36) Enkel stel axel
- 37) För fordon med fast konstruktion
- 38) För fordon med utan fast konstruktion
- 39) Skivhjul, bultdelningsdiam 335 mm
- 40) ABS/Ej ABS, Skivhjul, bultdelningsdiam 335 mm
- 41) Skivhjul, ch.-27087
- 42) Skivhjul, ch.27088-
- 43) Ekerhjul, 20" nav, ch.-27087
- 44) Ekerhjul 22" nav, ch.-27087
- 45) Ekerhjul, ch.27088-
- 46) Ekerhjul 20" nav
- 47) Ekerhjul, ej navreduktion
- 48) Skivhjul, ch.-19745
- 49) Skivhjul, ch.19746-
- 50) Luftfjädring och special design

Anmärkningar

- 51) Med "S-ride" och enkelhjul
52) Skivhjul, tidigare modeller
53) Ekerhjul, tidigare modeller
54) Byggsplatsfordon med stel framaxel och hög frigång
55) Ekerhjul, ABS/Ej ABS
56) Skivhjul, ABS/Ej ABS
57) Skivhjul, BGT 18/21/26 med bladfjädring bak
58) Skivhjul, luftfjädring."S-ride", styrande bakaxel
59) Luftfjädring och styrande bakaxel
60) ABS/Ej ABS, med bladfjädring.
61) Ch.-12099
62) Ch.12100-
63) Ch.12001-
64) Skivhjul, ch.-11549
65) Skivhjul, ch.11550-
66) Ch.-26821
67) Ch.26822-
68) Skivhjul, ch.-40640, ABS/Ej ABS
69) Ekerhjul, 20" nav, ej navreduktion
70) Ekerhjul, 24" nav, ej navreduktion
71) Skivhjul, ch.-20876, ABS/Ej ABS
72) Skivhjul, ch.20877-, ABS/Ej ABS
73) Skivhjul, ch.25001-40640, bultdelningsdiam 335 mm
74) Ekerhjul, 20" nav, ch.25001-40640
75) Ekerhjul 24" nav, ch.25001-40640
76) Luftfjädring, ch.-25000
77) S-ride, styrande bakaxel, ch.25001-40640
78) Skivhjul, med navreduktion
79) Ch.-52439
80) Ch.52440-
81) Skivhjul, ch.306000-, bultdelningsdiam 335 mm
82) Ekerhjul, 20", 24" nav, ch.306000-
83) Skivhjul, ch.306000-, ABS/Ej ABS, bultdelningsdiam 335
84) Skivhjul, ch.-46315
85) Skivhjul, ch.46316-, ABS/Ej ABS
86) Ekerhjul 24" nav, ch.49001-
87) Skivhjul 20", 22.5", 24" nav
88) Byggsplatsfordon med stel framaxel
89) Ekerhjul, 24" nav
90) Ch.-36763
91) Ch.36764-
92) Ch.-65820
93) Ch.-65820, Ekerhjul, 20", 24" nav
94) Skivhjul, ej navreduktion
95) Skivhjul, ch.-22914
96) Skivhjul, ch.22915-
97) Ekerhjul, 20" nav, ch.34001-
98) Ekerhjul 24" nav, ch.34001-
99) Luftfjädring
100) Special model, super volyme S-10609, S-10610, S-10801, S-11010, S-97024, S-97025, ch.314000-
101) Ekerhjul, 20", 24" nav
102) Ekerhjul, med enkelreduktion
103) Tandem axle med navreduktion
104) Enkelmonterade löphjul, skivhjul
105) Dubbelmonterade löphjul, skivhjul
106) Ch.-15169
107) Ch.15170-
108) Skivhjul, ch.-8779
109) Skivhjul, ch.8780-
110) Ekerhjul, ch.-12000
111) Ekerhjul, 20" nav, ch.12001-
112) Ekerhjul 24" nav, ch.12001-
113) Ekerhjul, 22", 22.5", 24" nav
114) Ekerhjul, 20" nav, med bladfjädring, ABS/Ej ABS
115) Ekerhjul, 24" nav, med bladfjädring
116) Ekerhjul, 20" nav, med luftfjädring
117) Ekerhjul, ch.314000-, med luftfjädring bak
118) Special model, super volume; 1) S-10099, S-10365, S-10803, S-11011 2) S-10111, S-10112, S-97024, S-97025
119) Ch.7980
120) Ch.7981-
121) Ch.-3404
122) Ch.3405-7980
123) Ch.-5256
124) Ch.5257-
125) B 6F
126) B 6FA
127) Ch.865-. Ej Ch.873-875, oljesmort
128) B 6F, B 609, B 610
129) B 6FA, ch.-404, nav 6772232
130) B 6FA, ch.405-
131) Ch.20000-
132) Ch.-10521. Fettsmort
133) Ch.10522-. Oljesmort
134) Fettsmort, styrande bakaxel
135) Oljesmort, styrande bakaxel, ABS/Ej ABS
136) Oljesmort
137) Ch.-3906
138) Ch.3907-
139) Ch.4308-. ABS
140) Med framaxel FAT 5,0
141) CHID-B169140, skivhjul, bultdelningsdiam 335 mm
142) Ej ABS, skivhjul, bultdelningsdiam 335 mm
143) Nav 6774825. Med framaxel FAT 4,7
144) CHID -B170985
145) CHID B170986-
146) S-60677, S-60936
147) Skivhjul, bultdelningsdiam 335 mm, med luftfjädring.
148) Skivhjul, bultdelningsdiam 335 mm, BAT 11,5 med bladfjädring
149) 6X2 TAG (HENDRICKSON)
150) 6774825, 6795568
151) Inkl. special modeller; S-60945, S-60990, S-60993, S-61208, S-61230
152) B 6FA, ch.-404. (Repl. 6772232, 6770991, 6771541, 960234, 6772691,95678, 18665. One pcs of each)
153) ABS/Ej ABS. Ch.5000-
154) Ch.5000-
155) CHID.-A276505, -B190367, -563621
156) BAT 10,0 BAT 10,9 BAT 11,2
157) BAT 11,5 BLF-B BAT 13,0
158) BAT 11,5 LUF-B
159) Med framaxel FAT 4,7
160) WTT-D275
161) Ch.-A286102, -B207062, D120498

Miten käytät luettelo

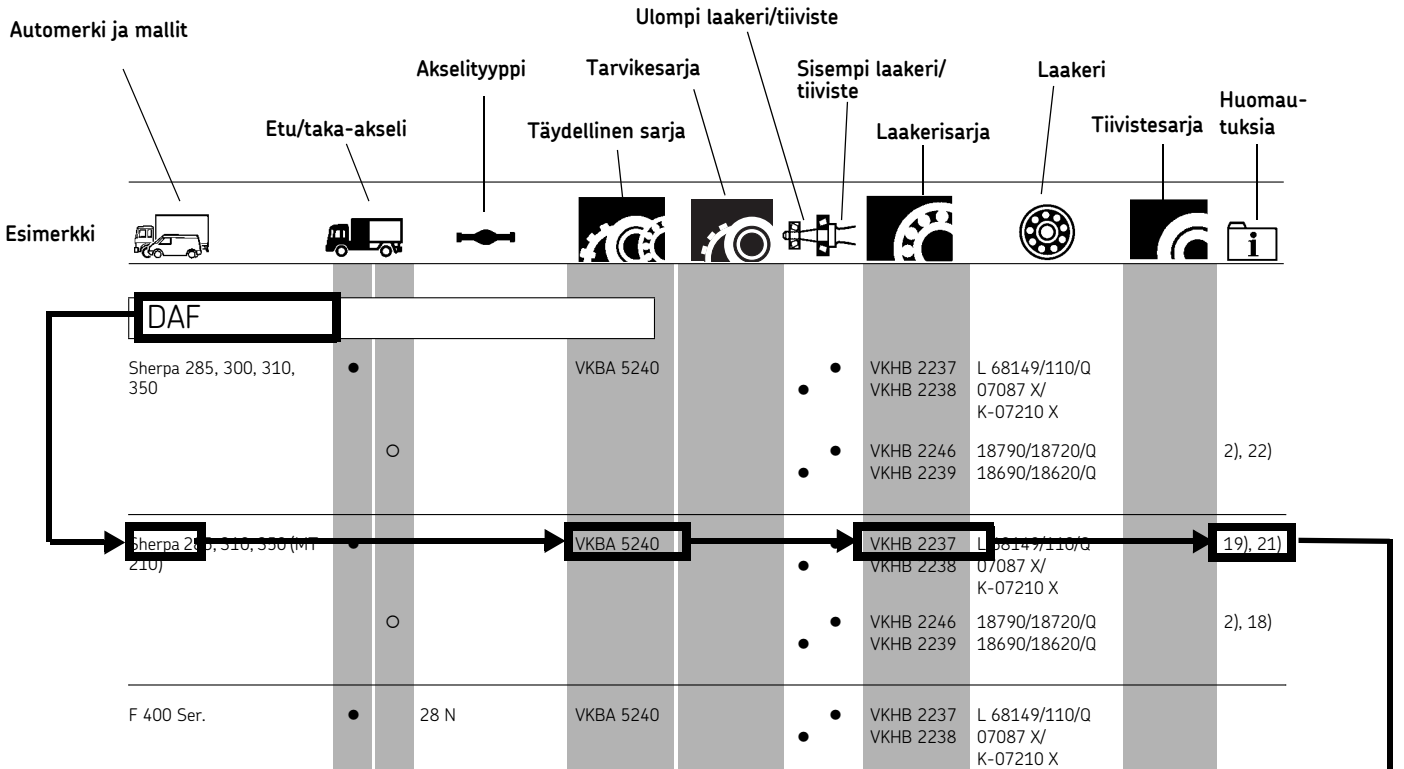













Sarjojen sisältö



	A	B	C	D	E	F	G	H	I	J	K	L		
VKA 4004							1		1				VOLVO	• ○
VKA 4026							1		1				VOLVO	○ ○
VKA 4036							2	1					SCANIA	○ ○
VKA 4038							1	1					SCANIA	○ ○
VKA 4094							2	1					MERCEDES-BENZ	• ○
VKA 4095							1	2					MERCEDES-BENZ	• ○

A	B	C	D	E	F	G	H	I	J	K	L	
Laakeri	Lukkolevy	Mutteri	Etäisysholkki	Puristusrennas	Varmistinrennas	Tiiviste	Tiiviste	O-rennas	Kulutuslevy/suojalevy	Saksisokka	Muut tarvikkeet	

VKBA = VKHB + VKHB + VKA/VKS

						
						
VKBA 5025 VKBA 5027	VKHB 2056 VKHB 2059	VKHB 2057 VKHB 2007	VKS 6299 VKS 6219			



Vertailu – alkuperäisnumerosta SKF: ään

		
BPW		FIAT / IVECO
02.5664.26.57 02.5664.46.57 02.5664.55.64 02.5664.55.64	VKS 6285 VKS 6287 VKS 6250 VKS 6251	0174592 0174595 0190069 0221664 0266487 0266487
	VKHB 2043 VKHB 2141 VKS 6171 VKHB 2222 VKHB 2147	1101597 1102042 1102042 1102042
		VKHB 2060 VKHB 2282 VKHB 2149

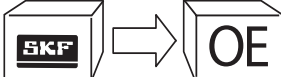
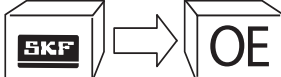



Vertailu – SKF:ään alkuperäisnumerosta

	
VKBA 519	VKBA 3616
VW VW VKBA 523 VKBA 528	RENAULT / RVI OPEL OPEL OPEL
FORD FORD FORDS BENZ	
211 498 071 211 498 071 BS 5 007 029 5 007 028 116 320 00 51	77 01 206 742 44 08 669 91160087 77 01 206 848 11 08 377

Laakeri - SKF VKHB

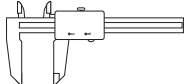
		
07087 X/K-07210 X 108 301	VKHB 2238 VKHB 2268	VKHB 2175
32310 TN9 32311 12	VKHB 2303 VKHB 2303	VKS 6219
		VKS 6219

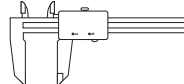
Tiivistemitat

					
d	D	W	d	D	W
44,0 53,0	85,0 97,0	10,0/8,0 8,0 12,0	VKS 6229 VKS 6219	117,4 118,0	142,8 12,7 27,0
			VKS 6108 VKS 6108		

Symbolit

Luettelon symbolit ja lyhenteet



Uudet korjaussarjat



Ajoneuvosovellukset, kuorma-autot



Ajoneuvosovellukset, linja-autot



Ajoneuvosovellukset, perävaunut



Sarjojen sisältö



VKBA=VKHB+VKHB+VKA/VKS



Vertailu – alkuperäisnumerosta SKF: ään



Vertailu – SKF:ään alkuperäisnumerosta



Laakeri - SKF VKHB



Tiivistemitat

Yleiset symbolit

→| Alkeen

|→ Asti



Korvaavat merkinät



Tuotannosta poistettu



Työkalut

Lyhennykset

Ch.	Alustan numero
Forward rear axle	Etummainen taka-akseli
Rear rear axle	Takimmainen taka-akseli
Trailing axle	Teli-akseli

VKBA XXXX	Tuotannossa
VKHB XXXX	Tuotannossa
VKA XXXX	Tuotannossa
VKS XXXX	Tuotannossa
VKN XXX	Tuotannossa

Huomautuksia



BPW

- 1) Lowloader
- 2) Ei lowloader

CITROËN

- 1) 09/81 - 12/89, Ch.-604496
- 2) 01/89 - 03/04, Ch.604497 -
- 3) 02/91 - 03/94
- 4) 01/87 - 12/89, Ch.-604496
- 5) 01/89 - 02/94, Ch. 604497 -
- 6) 09/81 - 12/86, vasen pyörä, Ch.-289710, hötykuorma : 1000, 1300 Kg
- 7) 09/81 - 12/86, oikea pyörä, Ch.-289710, hötykuorma : 1000, 1300 Kg
- 8) 09/81 - 03/94, vasen pyörä, hötykuorma :1800 Kg
- 9) 09/81 - 03/94, oikea pyörä, hötykuorma : 1800 Kg
- 10) 01/86 - 03/94, vasen pyörä, Ch.289711-, hötykuorma : 1000, 1300, 1400 Kg
- 11) 01/86 - 03/94, oikea pyörä, Ch.289711-, hötykuorma : 1000, 1300, 1400 Kg
- 12) 01/87 - 02/94,
- 13) 02/94 - 04/02, Ch.-16194399, hötykuorma :1000, 1400 Kg
- 14) 02/94 - 04/02, Ch.-16194399, hötykuorma : 1800 Kg
- 15) 02/94 - 04/02, Ch.16194400 -, hötykuorma : 1000, 1400 Kg
- 16) 02/94 - 04/02, Ch.16194400 -, hötykuorma : 1800 Kg
- 17) 04/02 - 09/04, hötykuorma : 1000, 1400 Kg
- 18) 04/02 - 09/04, hötykuorma : 1800 Kg
- 19) 03/94 - 04/02, Ch.-16194399, hötykuorma : 1000, 1400 Kg
- 20) 03/94 - 04/02, Ch.-16194399, hötykuorma : 1800 Kg
- 21) 03/94 - 04/02, Ch.16194400 -, hötykuorma : 1000, 1400 Kg
- 22) 03/94 - 04/02, Ch.16194400 -, hötykuorma : 1800 Kg
- 23) 08/96 - 04/02, Ch.-16194399, hötykuorma : 1000, 1400 Kg
- 24) 08/96 - 04/02, Ch.-16194399, hötykuorma : 1800 Kg
- 25) 08/96 - 04/02, Ch.16194400 -, hötykuorma : 1000, 1400 Kg
- 26) 08/96 - 04/02, Ch.16194400 -, hötykuorma : 1800 Kg
- 27) 02/94 - 04/02, Ch.16194400 -
- 28) Rumpujarruilla
- 29) Levyjarruilla

DAF

- 2) Paripyörillä
- 3) Raideväli 1718 mm, 10 pulttisella navalla
- 4) Raideväli 1655 mm, 8 pulttisella navalla
- 5) Ei napakeskitteinen
- 6) Napakeskityksellä
- 7) Napakeskityksellä. Sininen tiiviste
- 8) Napakeskityksellä. Musta tiiviste
- 9) Napavälityksellä
- 10) Ei FAR

- 11) Kanssa FAR
- 12) Ei FA, FT
- 13) Kanssa FA, FT
- 14) Ei napakeskitteinen. Sininen tiiviste
- 15) Ei napakeskitteinen. Musta tiiviste
- 16) Sininen tiiviste
- 17) Musta tiiviste
- 18) 1983-85
- 19) Ch.237886-,ykköspyörä, taka
- 21) 1984-85
- 22) 1985-12/89
- 23) -12/89
- 24) Öljytiiviste/ABS-kehä ei integroitu

FIAT-IVECO

- 4) Vasen pyörä
- 5) Oikea pyörä
- 8) Vasen pyörä, 06/79-06/81
- 9) Oikea pyörä, 06/79-06/81
- 10) 10/77-06/81
- 11) Vasen pyörä, 06/81-09/84
- 12) Oikea pyörä, 06/81-09/84
- 13) 06/81-09/84
- 14) Vasen pyörä, 10/84-88
- 15) Oikea pyörä, 10/84-88
- 16) 10/84-88
- 17) 03/85-88
- 18) Ch.-604496, 1982-89
- 19) Ch.604497-, 1989-93
- 20) Vasen pyörä, ch.-278757, 1982-86
- 21) Oikea pyörä, ch.-278757, 1982-86
- 22) Vasen pyörä, ch.278758-, 1986-93
- 23) Oikea pyörä, ch.278758-, 1986-93
- 24) 1982-86
- 25) Ch.-604496, 1986-89
- 26) Vasen pyörä, 1986-93
- 27) Oikea pyörä, 1986-93
- 28) 10/77-12/86
- 29) 01/87-
- 30) Ei 50-9 D, 50-9 V
- 31) 04/91-04/92
- 32) 01/85-
- 33) Levyjarruilla
- 34) 12/85-
- 36) 1991-94
- 37) Vasen pyörä, 1991-94
- 38) Oikea pyörä, 1991-94
- 39) Ei ABS
- 40) Ei Sveitsin mallit
- 41) Sveitsin mallit
- 42) Väilytys 4.23/1
- 43) Ei väilytys 4.23/1
- 44) Väilytys 4.23/1. Ei Sveitsin mallit
- 45) Ei väilytys 4.23/1.Ei Sveitsin mallit
- 46) Ei väilytys 3.79/1
- 47) Väilytys 3.79/1
- 48) CH. -173788
- 49) Ch.173789-. Akseli -1824487
- 50) Ch.173789-. Akseli 1824488-
- 51) Ch.173789-
- 52) Sisemmän laakerin halkaisija 95 mm
- 53) Sisemmän laakerin halkaisija 105 mm. Akseli -1824487
- 54) Sisemmän laakerin halkaisija 105 mm. Akseli 1824488-

- 55) Ohjaava akseli.Ei ohjaava akseli, varaosanumero 7177196
- 56) Ei ohjaava akseli, varaosanumero 7177168
- 57) Sisemmän laakerin halkaisija 100 mm
- 58) Akseli -1824487
- 59) Akseli 1824488-
- 60) Vasen pyörä, 06/79-01/97
- 61) Oikea pyörä, 06/79-01/97
- 62) 06/81-01/97
- 63) Vasen pyörä, 06/81-88
- 64) Oikea pyörä, 06/81-88
- 65) Ei väilytys 5.22/1. -02/96
- 66) Ei väilytys 5.22/1. -02/96
- 67) Vasen pyörä, 06/79-02/96
- 68) Oikea pyörä, 06/79-02/96
- 69) 10/77-09/84
- 70) Ei "Iveco check control"
- 71) "Iveco check control"
- 72) Vasen pyörä, -02/96
- 73) Oikea pyörä, -02/96
- 74) -2/96
- 75) Ei väilytys 5.62/1
- 76) Ei väilytys 5.62/1
- 77) ABS
- 78) Vasen pyörä, 03/85-88
- 79) Oikea pyörä, 03/85-88
- 81) 02/96
- 82) 03/96-
- 83) 1994-
- 84) 1996-
- 85) Yksirivinen kartiorullalakeri
- 86) Kaksirivinen kartiorullalakeri
- 87) Ei ohjaava akseli
- 88) Ohjaava akseli
- 89) Etuvetoinen
- 90) Ei etuvetoinen
- 91) Vasen etupyörä, yksirivinen kartiorullalakeri, 03/96 - 12/99
- 92) Oikea etupyörä, yksirivinen kartiorullalakeri, 03/96 - 12/99
- 93) Yksirivinen kartiorullalakeri, 03/96 - 12/99
- 94) Up to 05/89
- 95) 06/89 - 01/97
- 96) 01/96 - 12/99
- 97) Up to 12/99
- 98) 05/99 - 08/03
- 99) 06/81 - 01/97
- 100) 04/02 - 01/04
- 101) 07/02 - 01/04
- 102) Hötykuorma 1100, 1500 Kg
- 103) Hötykuorma 1800 Kg

FORD

- 1) 1965-91
- 2) 07/74-12/77
- 3) 08/65-12/77
- 6) 11/73-12/77
- 7) 01/78-10/85
- 8) Vasen pyörä, 11/85-91
- 9) Oikea pyörä, 11/85-91
- 10) 11/85-91
- 11) 1992-97
- 12) 01/81-03/87
- 13) 03/87-12/92
- 14) 04/82 - 09/87
- 15) 10/87 - 12/90 Vasen pyörä

Huomautuksia

- 16) 10/87 - 12/90 Oikea pyörä
- 18) 01/00 - 10/04
- 19) 01/00 - 10/04, ei ABS, hötykuorma 1000 Kg, FWD
- 20) 01/00 - 10/04, ABS, hötykuorma 1000 Kg, FWD
- 21) 07/03 - 10/04, ei ABS, hötykuorma 2000 Kg, FWD
- 22) 07/03 - 10/04, ABS, hötykuorma 2000 Kg, FWD
- 23) 01/00 - 10/04, ykköspyörä, RWD
- 24) 01/00 - 10/04, tuplapyörät, RWD
- 25) 03/04 - 10/04, ei ABS, hötykuorma 2000 Kg
- 26) 03/04 - 10/04, ABS, hötykuorma 2000 Kg

FRUEHAUF

- 1) 107,6 mm akseli, C1/C2/L1/L2 jarrut
- 2) 110 mm akseli, D1/K1/H1 jarrut
- 3) 110 mm akseli, C1/C2/L1/L2 jarrut (100 hammasta)
- 4) 110 mm akseli, C3/C5 jarrut (80 hammasta)

GIGANT (SAE)

- 1) Ilmajousitus, tyyppi N
- 2) Protec akseli

MAN

- 1) -11/93
- 2) 12/93-
- 3) W25/86-W27/90
- 4) W28/90-
- 5) Ei ABS
- 6) ABS
- 7) 01/90-
- 8) Napa. 81.35701.0081
- 9) Napa. 81.35701.0127
- 10) 20" TRILEX
- 11) Napa. 81.35701.0141
- 12) Except "TRILEX"
- 13) "TRILEX"
- 14) -W18/94
- 15) W19/94-
- 16) -W27/96
- 17) W28/96-, 19.5" napa
- 18) W28/96-, 20/22.5" napa

MERCEDES-BENZ

- 1) 02/88 - 02/96
- 2) 02/88 - 02/96, Ch.-128165
- 3) 1983-94
- 4) Ch.-48630
- 5) Ch.48631-
- 6) Dieselmoottori ch.-17768, bensiinimoottori ch.-1288
- 7) Dieselmoottori ch.17768-78114, bensiinimoottori ch.1289-4706
- 8) Dieselmoottori ch.78115-, bensiinimoottori ch.4707-
- 9) Sisemmän laakerin halkaisija 55 mm

- 10) Akseli -1358880
- 11) Akseli 1358881-
- 12) 02/88 - 02/96, Ch.128166-
- 13) Akseli -1278813
- 14) Akseli 1278814-
- 15) 02/88 - 05/92, avopakettiauto
- 16) 02/73 - 12/77
- 17) 01/95 - 05/02, to axle: S213915/Y245976
- 18) 01/95 - 05/02
- 19) Akseli -1390839
- 20) Akseli 1390840-
- 21) Akseli -1278313
- 22) Akseli 1278314-
- 23) 02/95 - 07/04, akseli: S231915/Y245976
- 24) Rumpujarruilla
- 25) ABS, akseli -021298
- 26) ABS, akseli 021299-
- 27) Akseli -724723
- 28) Akseli 724724-
- 29) Napa: 355 356 44 01
- 30) Napa: 346 356 30 01
- 31) 02/95 - 07/04
- 32) 02/96 - 05/02, To axle: S231915/Y245976
- 33) 02/96 - 05/02,
- 34) 09/96 - 07/04
- 35) 02/96 - 07/04
- 37) Napa: 668 356 01 01, 668 356 02 01
- 38) Napa: 972 356 01 01
- 39) Napa: 976 356 11 01
- 40) Napa: 678 356 04 01
- 41) Napa: 675 356 01 01
- 42) Levyjarruilla
- 43) Napa: 942 334 08 01
- 44) Napa: 942 334 07 01, 949 334 05 01

MERITOR (ROR)

- 1) Rasvavoidettu

MONTENEGRO

- 1) Akseli 061001243, 061001243A
- 2) Akseli 06-1-1068
- 3) Akseli 06-1-1176, 061001231
- 4) Akseli 061001271
- 5) Akseli 061001231A
- 6) Akseli 061001230, 061001230A
- 7) Akseli 06-1-1025
- 8) Akseli 061001170A
- 9) Akseli 061001299
- 10) Akseli 061001210, 061001210B, 061001295
- 11) Akseli 06-1-1103, 06-1-1170
- 12) Akseli 06-1-1100, 06-1-1102, 06-1-1106, 06-1-1108, 06-1-1173, 06-1-1174

OPEL

- 1) 09/00 - 10/01, pyörän halkaisija (tuumaa):15, Ch.-B 000010, Moottorikoodi::F9Q-770
- 2) 09/00 - 10/01, pyörän halkaisija (tuumaa):15, Ch. B 000011-, moottorikoodi:: F9Q-770

- 3) 07/98 - 10/01, pyörän halkaisija (tuumaa):16
- 4) 07/98 - 10/01, avopakettiauto, pyörän halkaisija (tuumaa):15, Ch.-B 0000514, B 006055, moottorikoodi: S8U-702
- 5) 07/98 - 10/01, Kuljetusvaunu, bussi Dumpertruck, pyörän halkaisija (tuumaa): 15, Ch.-B 051615, moottorikoodi:: S9W-702
- 6) 07/98 - 10/01, avopakettiauto, pyörän halkaisija (tuumaa):15, Ch.B 0000515-, B 006056-, moottorikoodi: S8U-702
- 7) 07/98 - 10/01, Kuljetusvaunu, bussi, Dumpertruck, pyörän halkaisija (tuumaa):15, Ch.B 051616-, moottorikoodi: S9W-702
- 8) 07/98 - 10/01, pyörän halkaisija (tuumaa):15
- 9) 07/98 - 10/01, pyörän halkaisija (tuumaa):16
- 10) 08/01 - 08/05, ei ABS, Ch.- 3V613233
- 11) 08/01 - 08/05, ABS, Ch.- 3V613233
- 13) 08/01 - 08/05

PEUGEOT

- 1) 01/83 - 11/88
- 2) 10/90 - 01/01
- 3) 09/81 - 12/89, Ch.-604496
- 4) 01/89 - 09/90, Ch.604497-
- 5) 09/81 - 12/85, vasen pyörä, hötykuorma 1000 Kg, 1300 Kg, Ch.-244300
- 6) 09/81 - 01/01, vasen pyörä, hötykuorma 1400 Kg
- 7) 09/81 - 01/01, vasen pyörä, hötykuorma 1800 Kg
- 8) 09/81 - 01/01, oikea pyörä, hötykuorma 1400 Kg
- 9) 09/81 - 01/01, oikea pyörä, hötykuorma 1800 Kg
- 10) 01/86 - 11/88, vasen pyörä, hötykuorma 1000 Kg, 1300 Kg, Ch. 244301-
- 11) 09/81 - 12/85, oikea pyörä, hötykuorma 1000 Kg, 1300 Kg, Ch.-244300
- 12) 01/86 - 11/88, oikea pyörä, hötykuorma 1000 Kg, 1300 Kg, Ch.244301-
- 13) 10/90 - 01/01, vasen pyörä, hötykuorma 1000 Kg, 1300 Kg
- 14) 10/90 - 01/01, oikea pyörä, hötykuorma 1000 Kg, 1300 Kg
- 15) 1967-09/70
- 16) 10/70-80
- 17) 1967-80
- 18) 1980-88
- 19) 03/94 - 04/02, hötykuorma 1000 Kg, 1400 Kg, Ch.-16194399
- 20) 03/94 - 04/02, hötykuorma 1800 Kg, Ch.-16194399
- 21) 03/94 - 04/02, hötykuorma 1000 Kg, 1400 Kg, Ch.16194400-
- 22) 03/94 - 04/02, hötykuorma 1800 Kg, Ch.16194400-
- 23) 04/02 - 07/04, hötykuorma 1000 Kg, 1400 Kg
- 24) 04/02 - 07/04, hötykuorma 1800 Kg
- 25) 07/96 - 04/02, hötykuorma 1000 Kg, 1400 Kg, Ch.-16194399
- 26) 07/96 - 04/02, hötykuorma 1800 Kg, Ch.-16194399

Huomautuksia

- 27) 07/96 - 04/02, hötykuorma 1000 Kg, 1400 Kg, Ch.16194400-
28) 07/96 - 04/02, hötykuorma 1800 Kg, Ch.16194400-
29) 03/04 - 04/02, Ch.16194400-
30) 04/02 - 07/04
31) 10/01 - 04/02
32) 11/00 - 09/01, hötykuorma 1000 Kg, 1400 Kg
33) 11/00 - 09/01, hötykuorma 1800 Kg
34) 07/96 - 04/02, rumpujarruilla
35) 07/96 - 04/02, levyjarruilla
36) 01/86 - 01/01, vasen pyörä, hötykuorma 1000 Kg, 1300 Kg, Ch.244301-
37) 01/86 - 01/01, oikea pyörä, hötykuorma 1000 Kg, 1300 Kg, Ch.244301-

RVI

- 12) -14/06/85
13) 17/06/85-
14) -12/82
15) 01/83-
16) -15/11/85
17) 18/11/85-
18) -1986
19) 1987-
22) 07/86-
23) -14/03/84
24) 15/03/84-
25) 10/84-01/86
26) 02/86-
27) -09/84
28) -01/86
29) 10/84-
30) -09/83
31) 10/83-
33) -08/79
34) 09/79-
35) -08/84 MOT 62030
36) -12/83
37) 01/84-
38) -12/85
39) 01/86-
40) 12/92-
41) -05/91
42) 06/91-03/93
43) 04/93-
44) -08/84 MOT 62030. -N
45) -08/84 MOT 62030. N 1540
47) 09/93-
48) Ei ABS. -08/91
49) ABS. -08/91
50) 09/91-03/93
51) 09/91-
52) -03/93
53) -08/91
54) -07/90
55) 08/90-
56) -02/91
57) 03/91-
58) -09/90
59) -02/92
60) 03/92-
61) -05/95
62) 06/95-
63) Rumpujarruilla
64) Lvyjarruilla
65) -2/85
66) 03/85-
67) -17/11/93
68) 18/11/93-
69) 10/87-
70) ABS
71) -12/92
72) 01/93 - 17/08-98
73) 01/77-14/03/84
74) 03/86-
75) Ei ABS. -08/91. ei "Trilex".
76) ABS. -08/91. Ei "Trilex".
77) "Trilex"-20". -03/93.
78) "Trilex"-24". -03/93.
79) 09/91-03/93. Ei "Trilex".
80) -2/86
81) -12/87
82) Lukkomutteri M75. -05/91
83) Lukkomutteri M70. -05/91
84) Ei ABS
85) Kanssa ABS
86) -05/95
87) 06/95-
88) -03/89
89) 04/89-
90) 1973-1989
91) Ei moottori G9T
92) Moottorilla G9T
96) 03/89 - 04/89, kuljetusvaunu, bussi, sisempi laakeri 35x72x24.5 mm
97) 03/89 - 04/89, kuljetusvaunu, bussi, sisempi laakeri 35x62x18.3 mm
98) 05/89 - 10/97, avopakettiauto
100) 03/80 - 04/89, kuljetusvaunu, bussi,
101) 03/80 - 04/89, avopakettiauto
102) 18/08/98 -
103) - 31/03/98
104) 01/04/98 -
105) - 27/08/98
106) - 24/08/98
107) - 17/08/98
108) Ykköpyörä
109) Tuplapyörät
110) 01/09/91 - 31/03/93
111) - 11/04/2000
112) 12/04/2000 -
113) 03/80 - 04/89
114) 03/80 - 12/83, kuljetusvaunu, bussi,
115) 03/80 - 02/89
116) 01/84 - 12/85, kuljetusvaunu, bussi,
117) 01/86 - 02/89, kuljetusvaunu, bussi,
118) 03/89 - 04/89
119) 05/89 - 01/01, kuljetusvaunu, bussi,
120) 05/89 - 01/01
121) 05/89 - 01/01, avopakettiauto, Model type:PC
122) 05/89 - 01/01, kuljetusvaunu, bussi, sisempi laakeri 35x72x24.5 mm
123) 05/89 - 01/01, kuljetusvaunu, bussi, sisempi laakeri 35x62x18.3 mm
124) 03/01 - 11/02, ei ABS
125) 03/01 - 11/02, kanssa ABS
126) 11/02 - 02/04
127) 03/01 - 02/04
128) 08/80 - 07/98, kuljetusvaunu, bussi,
129) 09/80 - 07/98, avopakettiauto
130) 07/98 - 03/00
131) 03/00 - 02/02

- 132) 07/98 - 01/01
133) 07/98 - 10/01, kuljetusvaunu, bussi,
134) 07/98 - 10/01, kuljetusvaunu, avopakettiauto
135) 09/00 - 02/04, kuljetusvaunu, rumpujarruilla
136) 09/00 - 02/04, kuljetusvaunu, lyjarruilla
137) 09/00 - 02/04, bussi rumpujarruilla
138) 09/00 - 02/04, bussi, lyjarruilla
139) 09/00 - 02/04, avopakettiauto, rumpujarruilla
140) 09/00 - 02/04, avopakettiauto, lyjarruilla
141) 07/98 - 01/01, kuljetusvaunu, rumpujarruilla
142) 07/98 - 01/01, kuljetusvaunu, lyjarruilla
143) 10/01 - 02/04, kuljetusvaunu, rumpujarruilla
144) 10/01 - 02/04, kuljetusvaunu, lyjarruilla
145) 07/98 - 01/01, bussi, rumpujarruilla
146) 07/98 - 01/01, bussi, lyjarruilla
147) 10/01 - 02/04, bussi, rumpujarruilla
148) 10/01 - 02/04, bussi, lyjarruilla
149) 07/98 - 01/01, avopakettiauto, rumpujarruilla
150) 07/98 - 01/01, avopakettiauto, lyjarruilla
151) 10/01 - 02/04, avopakettiauto, rumpujarruilla
152) 10/01 - 02/04, avopakettiauto, lyjarruilla
153) 07/98 - 10/01, kuljetusvaunu, rumpujarruilla
154) 07/98 - 10/01, kuljetusvaunu, lyjarruilla
155) 07/98 - 10/01, avopakettiauto, rumpujarruilla
156) 07/98 - 10/01, avopakettiauto, lyjarruilla
157) 10/03 - 02/04, kuljetusvaunu, rumpujarruilla
158) 10/03 - 02/04, kuljetusvaunu, lyjarruilla
159) 10/03 - 02/04, bussi, rumpujarruilla
160) 10/03 - 02/04, bussi, lyjarruilla
161) 10/03 - 02/04, avopakettiauto, rumpujarruilla
162) 10/03 - 02/04, avopakettiauto, levyjarruilla

SCANIA

- 1) Ch.-1032241
2) Ch.1032242-
3) Levypyörä, ch.-1032241
4) Levypyörä, ch.1032242-
5) Tykkipyörä
6) Levypyörä, ch.-1097602 SSS, ch.-4246024 SN
7) Levypyörä, ch.1097603 SSS-, ch.4246025 SN-
8) Tykkipyörä, ch.-1105665 SSS, ch.-4238514 SN
9) Tykkipyörä, ch.1105666 SSS-, ch.4238515 SN-
10) Levypyörä
11) Tykkipyörä, runkoleveys 2300 mm
12) Tykkipyörä 20" or 22.5" napa, ch.-1103187 SSS, ch.-4248317 SN
13) Tykkipyörä 20" or 22.5" napa, ch.1103188 SSS-, ch.4248318 SN
14) Tykkipyörä, 24" napa
15) Ch.-1097602 SSS, ch.-4246024 SN
16) Ch.1097603 SSS-, ch.4246025 SN-
17) Levypyörä, ch.-1033747
18) Levypyörä, ch.1033748-
19) Tykkipyörä 20" or 22" napa, ch.-1103187 SSS, ch.-4248317 SN
20) Tykkipyörä, 20" or 22" napa, ch.1033188 SSS-, ch.4248318 SN-



Huomautuksia

- 21) Levypyörä, Tykkipyörä
 22) Levypyörä, (4x2, 6x2, 6x4)
 23) Tykkipyörä, (4x2, 6x2, 6x4) 20" or 22,5" napa
 24) Tykkipyörä, 24" napa. Runkoleveys 178 mm
 25) Tykkipyörä, 24" napa. Runkoleveys 203 mm
 26) Tupla ohjaava akseli
 27) Tykkipyörä, 20", 22,5" or 24" napa
 28) Ei napavälitystä
 29) Napavälityksellä
 30) Levypyörä, ch.-1029858
 31) Levypyörä, ch.1029859-
 32) Levypyörä, Tykkipyörä, 24" napa
 33) Levypyörä, tykkipyörä, 20" or 22,5" napa
 34) Levypyörä, tykkipyörä, 20", 22,5" or 24" napa
 35) Levypyörä, ch.-1161721 SSS, ch.-4292924 SN
 36) Levypyörä, ch.1161722 SSS-, ch.4292925 SN-
 37) Levypyörä, tykkipyörä, 24" napa, ch.-1180029 SSS
 38) Levypyörä, tykkipyörä, 24" napa, ch.1180030 SSS-
 39) Levypyörä, ch.-1850412
 40) Levypyörä, ch.1850413-
 41) Lehtijousitus. ch.-1801229
 42) Lehtijousitus. ch.1801230-
 43) Ilmajousitus, ch.-1802872
 44) Ilmajousitus, ch.1802873-
 45) Ch.-1801229
 46) Ch.1801230-
 47) Levypyörä, ABS/ei ABS
 48) ABS/ei ABS
 49) Ilmajousitus
 50) Ilmajousitus ABS
 51) Ilmajousitus, trapeze suspension
 52) Ilmajousitus, trapeze suspension. ABS
 53) Disc wheel, ch.-1871409
 54) Ch.1871410-1871595
 55) Ch.1871596-
 56) Ch.1871410-
 57) Runkoleveys 5"
 58) Runkoleveys 7". Ch.1801196-
 59) Ch.-1801195
 60) Ch.1801196-
 61) Ch.-1808231
 62) Ch.1808232-
 63) ABS/ei ABS. Ch.-1808901, Ch.1808902
 64) ABS/ei ABS. Ch.-1806768, Ch.1806769-
 65) Hub for trailing axle
 66) Levypyörä, ABS/ei ABS. Ch.-1808901, Ch.1808902-
 67) Ilmajousitus. 22,5" napa
 68) Ilmajousitus. 22,5" napa. ABS
 69) ABS
 70) Napa 8.25 x 22,5"
 71) Napa 8.25 x 22,5". ABS
 72) Napa 9.00 x 22,5"
 73) Napa 9.00 x 22,5". ABS
 74) 6.5 tons
 75) 6.5 tons. ABS
 76) 7.1 tons
 77) 7.1 tons. ABS
 78) 6.5 tons. Ch.-1820117, Ch.1820118-
 79) 6.5 tons. Ch.-1820117. ABS
 80) 7.1 tons. Ch.-1820117
 81) 7.1 tons. Ch.-1820117. ABS
 82) ABS/ei ABS. Ch.-1820117, Ch.1820118-
 83) Ilmajousitus, ch.-1801229
 84) Ilmajousitus, ch.1801230-1802872
 85) Levypyörä, ei ABS, Ch.9015825 SAN-, Ch.4362206 SNL-, Ch.1226892 SSS-
 86) Levypyörä, ABS, Ch.9015825 SAN-, Ch.4362207 SNL-, Ch.1226892 SSS-
 87) tykkipyörä, ABS/ei ABS
 88) Levypyörä, ABS/ei ABS, Ch.9015825 SAN-, Ch.4362207 SNL-, Ch.1226892 SSS-
 89) Levypyörä, ei ABS, Ch.9015825 SAN-, Ch.4362207 SNL-, Ch.1226207 SSS-
 90) Levypyörä, ei ABS
 91) Levypyörä, ei ABS, RP/RBP 730
 92) Ei ABS, RP/RBP 832
 93) Levypyörä, ABS
 94) Levypyörä/tykkipyörä, ABS/ei ABS, Ch.9015825 SAN-, Ch.4362207 SNL-, Ch.1226892 SSS-
 95) Tykkipyörä, ei ABS
 96) Levypyörä, Ch.1820118-, ABS
 97) Levypyörä, Ch.1820118-, ei ABS
 98) To Ch.nr: Scania Sodertalje 1242205, Scania Zwolle 4397541, Scania Angers 9034654, Scania Katrineholm 1833391
 99) Levypyörä, levyjarruilla, ABS
 100) Tykkipyörä 22", 22,5" napa
 101) RP/RBP 832
 102) 22", 22,5", 24" napa
 103) 20", 22,5" napa, RBP/RP730
 104) 24" napa, RP/RBP 832
 105) Levypyörä Ch.-9015824 SAN, Ch.-4365570 SNL, Ch.-1226891 SSS
 106) Levypyörä, ABS, Ch.-9015824 SAN, Ch.-4362206 SNL, Ch.-1226891 SSS
 107) Levypyörä, levyjarruilla, ABS/ei ABS
 13) Ch.-28-B-019162, 1979-81
 14) Ch.28-B-019163-, 1981-82
 15) 1983-96
 16) 3500 kg, 1983-96
 17) 4000 kg, 1983-96
 18) 1984-96
 19) 05/96 - 10/04
 20) 05/96 - 10/04, Mod. LT 28, LT 35
 21) 05/96 - 10/04, Mod. LT 46
 22) 08/67 - 07/79
 23) 08/71 - 12/73
 24) 08/75 - 07/79
 25) 08/70 - 07/92
 26) 08/79 - 12/82
 27) 08/79 - 12/84, Ch.-24-E-023827
 28) 01/84 - 07/92, Ch.24-E-023828 -
 29) 10/86 - 07/92
 30) 01/84 - 07/92, Ch.24-E-023828 -
 31) 08/85 - 07/92
 32) 11/84 - 07/92
 33) 08/75 - 07/92
 34) 07/90 - 10/04
 35) 10/92 - 10/04
 36) 07/90 - 10/04, 800-1200 Kg
 37) 10/92 - 10/04, 800-1200 Kg
 38) 04/03 - 09/04, Ch.-7 H-4-017500, 7J-4-017500
 39) 07/04 - 09/04, Ch.-7 H-4-017500, 7J-4-017500
 40) 04/03 - 10/04
 41) 07/04 - 10/04

VOLVO

- 1) Napa 363067
 2) 57 mm akselitappi
 3) Ch.-20653
 4) Levypyörä, ch.20654-
 5) Tykkipyörä, ch.20654-
 6) Levypyörä, Tykkipyörä, -1503875
 7) Tykkipyörä, 1503876-
 8) Ei napavälitystä, ch.36634-
 9) Napavälityksellä
 10) Ei napavälitystä
 11) Levypyörä
 12) Tykkipyörä
 13) Ch.-6997
 14) Levypyörä, ch.6998-
 15) Tykkipyörä, ch.6998-
 16) Kovat jouset
 17) Pehmeät jouset
 18) Ch.-7050
 19) Ch.7051-
 20) Ch.-23510
 21) Ch.23511-
 22) Ch.-2376
 23) Ch.2377-
 24) Ch.-6450
 25) Ch.6451-
 26) Ch.-703
 27) Ch.704-
 28) Ch.-21671
 29) Ch.21672-
 30) Ch.-3145 (approx.)
 31) Ch.3146 (approx.)-6871
 32) Ch.6872-
 33) Ch.-2728

SMB

- 1) 107,6 mm akseli, C1/C2/L1/L2 jarrut
 2) 110 mm akseli, D1/K1/H1 jarrut
 3) 110 mm akseli, C1/C2/L1/L2 jarrut (100 hammasta)
 4) 110 mm akseli, C3/C5 jarrut (80 hammasta)

TRAILOR

- 1) 107,6 mm akseli, C1/C2/L1/L2 jarrut
 2) 110 mm akseli, D1/K1/H1 jarrut
 3) 110 mm akseli, C1/C2/L1/L2 jarrut (100 hammasta)
 4) 110 mm akseli, C3/C5 jarrut (80 hammasta)

VOLKSWAGEN

- 1) 1976-96
 5) Ch.21N-006786 -, 08/91-96, 22,5 mm puristusrenkas
 7) Ei tuplapyörät, Ch.28G-015892 - 21N-006785, 04/86-07/91, 20 mm puristusrenkas
 8) Ei tuplapyörät, Ch.21N-006786 -, 08/91-96, 22,5 mm puristusrenkas
 9) Kierrejouset, 1979-82
 10) Lehtijouset, ch.-28-B-018540, 1979-81
 11) Lehtijouset, ch.28-B-018541-, 1981-82
 12) 1979-82

Huomautuksia

- 34) Ch.2729-6871
35) ABS/ei ABS
36) Jäykkä akseli
37) Ajoneuvot kiinteällä rakenteella
38) Ajoneuvot, ei kiinteällä rakenteella
39) Levypyörä, pulttikehä 335 mm
40) ABS/ei ABS. Levypyörä, pulttikehä 335 mm
41) Levypyörä, ch.-27087
42) Levypyörä, ch.27088-
43) Tykkipyörä 20" napa, ch.-27087
44) Tykkipyörä 22" napa, ch.-27087
45) Tykkipyörä, ch.27088-
46) Tykkipyörä 20" napa
47) Tykkipyörä, ei napavälitystä
48) Levypyörä, ch.-19745
49) Levypyörä, ch.19746-
50) Ilmajousituksella ja special design
51) S-ride ja singelipyörä
52) Levypyörä, aiemmat mallit
53) Tykkipyörä, aiemmat mallit
54) Rakennustyömaa-auto jäykkällä etuakselilla ja korkealla askelmalla
55) Tykkipyörä, ABS/ei ABS
56) Levypyörä, ABS/ei ABS
57) Levypyörä, BGT 18/21/26 lehtijousitus
58) Levypyörä, ilmajousitus, S-ride, ohjaava taka-akseli
59) Ilmajousituksella ja ohjaavalla taka-akselilla
60) ABS/ei ABS, lehtijousitus.
61) Ch.-12099
62) Ch.12100-
63) Ch.12001-
64) Levypyörä, ch.-11549
65) Levypyörä, ch.11550-
66) Ch.-26821
67) Ch.26822-
68) Levypyörä, ch.-40640, ABS/ei ABS
69) Tykkipyörä 20" napa, ei napavälitystä
70) Tykkipyörä 24" napa, ei napavälitystä
71) Levypyörä, ch.-20876, ABS/ei ABS
72) Levypyörä, ch.20877-, ABS/ei ABS
73) Levypyörä, ch.25001-40640, pulttikehä 335 mm
74) Tykkipyörä 20" napa, ch.25001-40640
75) Tykkipyörä 24" napa, ch.25001-40640
76) Ilmajousituksella, ch.-25000
77) S-ride, ohjaava taka-akseli, ch.25001-40640
78) Levypyörä, napavälityksellä
79) Ch.-52439
80) Ch.52440-
81) Levypyörä, ch.306000-, pulttikehä 335 mm
82) Tykkipyörä 20", 24" napa, ch.306000-
83) Levypyörä, ch.306000-, ABS/ei ABS, pulttikehä 335
84) Levypyörä, ch.-46315
85) Levypyörä, ch.46316-, ABS/ei ABS
86) Tykkipyörä 24" napa, ch.49001-
87) Levypyörä 20", 22.5", 24" napa
88) Rakennustyömaa-auto jäykkällä etuakselilla
89) Tykkipyörä 24" napa
90) Ch.-36763
91) Ch.36764-
92) Ch.-65820
93) Ch.-65820, Tykkipyörä 20", 24" napa
94) Levypyörä, Ei napavälitystä
95) Levypyörä, ch.-22914
96) Levypyörä, ch.22915-
97) Tykkipyörä 20" napa, ch.34001-
98) Tykkipyörä 24" napa, ch.34001-
99) Ilmajousituksella
100) Erikoismalli, super volyme S-10609, S-10610, S-10801, S-11010, S-97024, S-97025, ch.314000-
101) Tykkipyörä, 20", 24" napa
102) Tykkipyörä, yksinkertaisella välityksellä
103) Tandemi akseli napavälityksellä
104) Ykköspyörä teli, levypyörät
105) Paripyörillä varustetut telit, levypyörä
106) Ch.-15169
107) Ch.15170-
108) Levypyörä, ch.-8779
109) Levypyörä, ch.8780-
110) Tykkipyörä, ch.-12000
111) Tykkipyörä 20" napa, ch.12001-
112) Tykkipyörä 24" napa, ch.12001-
113) Tykkipyörä 22", 22.5", 24" napa
114) Tykkipyörä 20" napa, lehtijousitus, ABS/ei ABS
115) Tykkipyörä 24" napa, lehtijousitus
116) Tykkipyörä 20" napa, ilmajousituksella
117) Tykkipyörä, ch.314000-, ilmajousituksella
118) Erikoismalli, super volume: 1) S-10099, S-10365, S-10803, S-11011 2) S-10111, S-10112, S-97024, S-97025
119) Ch.7980
120) Ch.7981-
121) Ch.-3404
122) Ch.3405-7980
123) Ch.-5256
124) Ch.5257-
125) B 6F
126) B 6FA
127) Ch.865-. Ei ch.873-875, öljyvaideltu
128) B 6F, B 609, B 610
129) B 6FA, ch.-404, napa 6772232
130) B 6FA, ch.405-
131) Ch.20000-
132) Ch.-10521.Rasvavoideltu
133) Ch.10522-. Öljyvaideltu
134) Rasvavoideltu, ohjaavalla taka-akselilla
135) Öljyvaideltu, ohjaavalla taka-akselilla, ABS/ei ABS
136) Öljyvaideltu
137) Ch.-3906
138) Ch.3907-
139) Ch.4308-. ABS
140) Sisältäen etuakseli FAT 5,0
141) CHID-B169140, levypyörä, pulttikehä 335 mm
142) Ei ABS, Levypyörä, pulttikehä 335 mm, disc
143) Napa 6774825. Sisältäen etuakseli FAT 4,7
144) CHID -B170985
145) CHID B170986-
146) S-60677, S-60936
147) Levypyörä, pulttikehä 335 mm, ilmajousituksella
148) Levypyörä, pulttikehä 335 mm, BAT 11,5, lehtijousitus
149) 6X2 TAG (HENDRICKSON)
150) 6774825, 6795568
151) Incl. special model; S-60945, S-60990, S-60993, S-61208, S-61230
152) B 6FA, ch.-404. (Repl. 6772232, 6770991, 6771541, 960234, 6772691,95678,18665. One pcs of each)
153) ABS/ei ABS. Ch.5000-
154) Ch.5000-
155) CHID.-A276505, -B190367, -563621
156) BAT 10,0 BAT 10,9 BAT 11,2
157) BAT 11,5 BLF-B BAT 13,0
158) BAT 11,5 LUF-B
159) Sisältäen etuakseli FAT 4,7
160) WTT-D275
161) Ch.-A286102, -B207062, D120498



SKF – the knowledge engineering company

From the company that invented the self-aligning ball bearing 100 years ago, SKF has evolved into a knowledge engineering company that is able to draw on five platforms to create unique solutions for its customers. These platforms include bearings, bearing units and seals, of course, but extend to other areas including: lubricants and lubrication systems, critical for long bearing life in many applications; mechatronics that combine mechanical and electronics knowledge into systems for more effective linear motion and sensorized solutions; and a full range of services, from design and logistics support to conditioning monitoring and reliability systems.

Though the scope has broadened, SKF continues to maintain the world's leadership in the design, manufacture and marketing of rolling bearings, as well as complementary products such as radial seals. SKF also holds an increasingly important position in the market for linear motion products, high-precision aerospace

bearings, machine tool spindles and plant maintenance services.

The SKF Group is globally certified both to ISO 14001, the international standard for environmental management, as well as OHSAS 18001, the health and safety management standard.

With some 100 manufacturing sites worldwide and sales companies in 70 countries, SKF is a truly international corporation. In addition, our distributors and dealers in some 15 000 locations around the world, an e-business marketplace and a global distribution system put SKF close to customers for the supply of both products and services. In essence, SKF solutions are available wherever and whenever customers need them. Overall, the SKF brand and the corporation are stronger than ever. As the knowledge engineering company, we stand ready to serve you with world-class product competencies, intellectual resources, and the vision to help you succeed.

SKF is a registered trademark of the SKF Group.

© SKF Group 2009

The contents of this publication are the copyright of the publisher and may not be reproduced (even extracts) unless permission is granted. Every care has been taken to ensure the accuracy of the information contained in this publication but no liability can be accepted for any loss or damage whether direct, indirect or consequential arising out of the use of the information contained herein.

Publication **PUB 80/P1 6251 EN E 06**

This publication supersedes publication PUB 80/P1 5362 EN 03.

Printed in Italy

Wheel bearing kits, seals and tools for commercial vehicles



www.vsm.skf.com

© SKF Group 2009
PUB 80/P1 6251 EN E 06

